

RISA-2D

Rapid Interactive Structural Analysis - 2-Dimensional

Version 20- General Reference



RISA Tech, Inc.

27442 Portola Pkwy, Suite 200

Foothill Ranch, California 92610

(949) 951-5815

(949) 951-5848 (FAX)

risa.com

Copyright © 2022 RISA Tech, Inc. All Rights Reserved. RISA is part of the [Nemetschek Group](#). No portion of the contents of this publication may be reproduced or transmitted in any means without the express written permission of RISA Tech, Inc. RISA and the RISA logo are registered trademarks of RISA Tech, Inc.

We have done our best to ensure that the material found in this publication is both useful and accurate. However, please be aware that errors may exist in this publication, and that RISA Tech, Inc. makes no guarantees concerning accuracy of the information found here or in the use to which it may be put.

Table of Contents

Before You Begin	1	AISI Steel Code Check Results	32
Overview	1	Assumptions and Limitations	34
Minimum System Requirements	1	Special Messages	36
Program Limits	2	Concrete Member - Database	37
License Agreement	2	Custom Rebar Layout Database	37
Maintenance (Perpetual License Only)	2	Concrete Member - Design	42
Application Interface	4	Concrete Spans	42
Main Menu	4	Concrete Design Parameters - Columns	43
Shortcut Menu	7	Concrete Design Parameters - Beams	46
Toolbars	7	T-beam & L-beam Sections	47
Dynamic View Controls	11	Parabolic vs. Rectangular Stress Blocks	48
Shortcut Keys and Hot Keys	12	Biaxial Bending of Columns	48
Status Bar	13	British Eurocode Design Parameters (BS EN 1992-1-1: 2004)	49
Windows	14	Limitations - General	50
Modes	15	Limitations - ACI	50
Aluminum - Databases	16	Limitations - Canadian Code	51
Aluminum Shape Types	17	Limitations - Australian and New Zealand Codes	51
Aluminum - Design	19	Limitations - British	51
Design Parameters	19	Limitations - Euro	51
Aluminum Code Check	20	Limitations - Indian	52
Aluminum Detail Report	21	Limitations - Saudi Code	52
Assumptions and Limitations	22	Special Messages	52
Special Messages	22	Concrete Member - Design Results	54
Boundary Conditions	23	Beam Results	54
Creating and Modifying Boundary Condi- tions	23	Column Results	56
Boundary Conditions Spreadsheet	24	Concrete Detail Reports	58
Boundary Condition Options	24	Beam Detail Reports	58
Boundary Conditions at Wall Panels	26	Column Detail Reports	62
Cold Formed Steel - Databases	27	Customizing RISA-2D	67
Custom vs. Manufacturer Shapes	27	Save as Defaults	67
Cold Formed Shape Types	28	Application Settings (Preferences)	67
Cold Formed Steel - Design	30		
Design Parameters	30		

Member Design Optimization	74
Member Design Lists	74
Member Design Rules – Size / U.C.	74
Member Design Rules – Deflection	75
Member Design Rules – Concrete Rebar	75
Member Design Rules Editor	76
Member Optimization Procedure	79
Optimization Results	79
Drift	81
Drift Definitions Spreadsheet	81
Drift Results	82
Drift Modeling Tips	84
DXF Files	86
Importing DXF Files	86
Exporting DXF Files	87
Merge After Importing a DXF File	90
DXF Element Numbers	90
DXF File Format	90
Dynamic Analysis - Eigensolution	93
Required Number of Modes	94
Dynamic Mass	94
Eigensolution Convergence	94
Saving Dynamic Solutions	94
Work Vectors	95
Dynamics Modeling Tips	95
Calculate Residual Mass	96
Modal Frequency Results	96
Mode Shape Results	97
Dynamics Troubleshooting – Local Modes ..	98
Dynamic Analysis - Response Spectra	99
Response Spectra	100
Response Spectra Analysis Procedure	100
Frequencies Outside the Spectra	100
Mass Participation	101
Modal Combination Option	101
Other Options	103

RSA Scaling Factor (Manual Scaling)	103
Automatic Response Spectra Generation ...	104
Adding and Editing Spectra	105
Tripartite Response Spectra Plot	106
Single Spectra Plot	107
File Operations	109
Starting Off	109
Appending Models	109
Importing and Exporting Files	110
Automatic Backup	110
Generation	112
Continuous Beam Generation	112
Circular Arc Generation	114
Parabolic Arc Generation	114
Grid Member Generation	115
General Truss Generation	116
Geodesic Dome Generator	118
Cylinder Generation	118
Cone Generation	118
Grid Plate Generation	118
Circular Disk Generation	119
Circular Radius Generation	119
(Global) Model Settings	121
Description	121
Solution	122
Codes	124
Concrete	125
Graphic Display	127
Multiple Windows	127
Controlling the Model View	127
Depth Effect	130
Viewing Part of the Model	130
Saving and Retrieving Model Views	130
Model Display Options	131
Joints	131
Members	132

Plates	133	Unbraced Lengths	177
Panels	135	K Factors (Effective Length Factors)	177
Loads	136	Sway Flags	177
Deflection Diagrams	137	AISC Design Codes - Limitations	179
Miscellaneous	138	AISC Design Codes - Special Messages ...	181
Graphic Editing	140	Canadian Design Codes - Limitations	182
Drawing and Modification Features	140	Canadian Design Codes - Special Messages	184
Undo Operations	141	British Design Code - Limitations	185
Redo Operations	141	EuroCode Design Codes - Limitations	187
Drawing Grid	141	EuroCode Design Codes - Special Mes-	188
Snap Points	144	sages	188
Import DXF	145	Indian Design Codes - Limitations	189
Copying Model Elements	147	Australian & New Zealand Design Codes -	189
Moving and Rotating Model Elements	150	Member Design Parameters	189
Scaling Elements	151	Australian & New Zealand Design Codes -	190
Merging Model Elements	152	Limitations	190
Trim/Extend Members	152	AISC 13th, 14th, and 15th Editions -	191
Deleting Elements	155	Design Guide 25	191
Re-Labeling Selected Elements	156	ASD 9th, LRFD 2nd, LRFD 3rd	193
Graphic Selection	157	Foreign Codes	193
Selection Modes	158	Hot Rolled Steel - Design Results	195
Inverting Selections	158	AISC Code Check Results	195
Criteria Selections	159	Canadian Code Check Results	196
Lock & Dim Lock	163	British Code Check Results	198
Viewer Mode	164	EuroCode Code Check Results	200
Graphic Selection from Spreadsheets	166	Indian Code Check Results	202
Saving Selections	167	Australian Code Check Results	204
Help Options	168	New Zealand Code Check Results	205
Electronic Help File	168	Tapered Member Results	207
Context Sensitive Help	168	Joints	209
RISA Tech, Inc. Online	168	Joint Coordinates Spreadsheet	209
Tool-tips	168	Joint Information Dialog	210
Tutorials	168	Joints - Results	212
Hot Rolled Steel - Databases	169	Joint Deflections Results	212
Hot Rolled Steel - Design	175	Joint Reaction Results	212
Design Parameters Spreadsheet	176	Joints - Tethering Joints	214
		Loads	215
		Self Weight (Gravity Load)	215

Drawing Loads	215	Thermal Force Calculation	250
Modifying Loads	216	Prestressing with Thermal Loads	250
Deleting Loads	216	Material Properties	251
Loads - Basic Load Cases	217	Material Properties Spreadsheet	251
Basic Load Case Spreadsheet	217	Material Take-Off	256
Copying Basic Load Cases	218	Members	257
Deleting Basic Load Cases	218	Drawing Members	257
Load Categories	218	Modifying Member Properties	258
Loads - Load Combinations	220	Material and Cross Section Properties	260
Load Combinations Spreadsheet	220	Modifying Member Design Parameters	260
Load Combinations with RSA Results	222	Splitting Members	261
Load Combinations with Moving Loads	223	Members Spreadsheet - Primary Data	262
Nesting Load Combinations	224	Members Spreadsheet - Advanced Data	264
ASIF Factors for Wind / Seismic Load Com- binations	224	Tension/Compression-Only Members	265
P-Delta Load Combinations	225	Member Information Dialog	268
Timber Design Load Duration Factor	225	Physical Members	269
Generating Building Code Combinations	225	Member Local Axes	270
Loads - Joint Load / Displacement	229	Defining Member Orientation	271
Drawing Joint Loads	229	Member End Releases	272
Joint Load Spreadsheet	230	Deflection Ratio Options	272
Joint Mass	230	Top of Member Offset	274
Loads - Point Loads	233	Member End Offsets	275
Drawing Point Loads	233	Inactive and Excluded Elements	275
Point Load Spreadsheet	234	Member Shear Deformations	276
Point Load Directions	234	Member Shear Areas	276
Loads - Distributed Loads	236	Member Shear Stresses	276
Drawing Distributed Loads	236	Members - Results	278
Distributed Loads Spreadsheet	237	Number of Reported Sections	278
Distributed Load Directions	238	Number of Internal Sections	278
Loads - Moving Loads	241	Member Force Results	279
Moving Loads Spreadsheet	242	Member Stress Results	280
Moving Load Patterns	243	Single Angle Results	282
Moving Loads Solution Procedure	245	Member Deflection Results	283
Moving Loads Results	245	Model Merge	285
Loads - Thermal Loads	249	Model Merge Options	285
Recording Thermal Loads for Members	249	Model Merge Examples	286

Model Merge Limitations	286	Plate Error Checking	310
Model Merge Process	286	Finite Element Basics	311
Modeling Tips	289	Plates/Shells - Results	313
Applying In-Plane Moment to Plates	289	Plate Stress Results	313
Modeling a Beam Fixed to a Shear Wall ..	289	Plate Force Results	313
Modeling a Cable	290	Plate Corner Force Results	314
Modeling Inclined Supports	291	Plates/Shells - Design Tools	316
Reactions at Joints with Enforced Dis-		Internal Force Summation Tool	316
placements	291	Contour Display Details	318
Rigid Links	292	Plates/Shells - Modeling Examples	320
Modeling a "Gap" (Expansion Joint)		Shear Wall Modeling	320
Between Structures	292	Shear Wall Design Forces	321
P-Delta - Analysis	294	Shear Wall Penetrations	323
P-Delta Procedure	294	Plate Connectivity Problems	323
P-Delta Limitations on Standard Nodal		Mesh Transition Examples	324
Shear Method	295	Printing	326
Compression Only P-Delta	296	Printing Reports	327
P-Delta Convergence	296	Printing to a File	328
P-Delta Troubleshooting	296	Graphics Printing	330
Wall Panels	297	Results	331
Leaning Column Effect	297	Saving Results	331
P-Little Delta Analysis	298	Results Spreadsheets	332
P-Little Delta Procedure	298	Excluding Results	332
AISC Direct Analysis Method	299	Graphic Results	333
ACI Concrete Design	299	Clearing Results	333
Plates/Shells	300	Internal Force Summation Tool	333
Drawing Plates	300	Member Detail Report	333
Modifying Plates	301	Concrete Member Detail Reports	338
Submeshing Plates	303	Section Sets	339
Plates Spreadsheet - Primary Data	305	Section Sets Spreadsheet	339
Plates Spreadsheet - Advanced Data	306	Shape Databases	341
Plate Information Dialog	306	Database Shape Types	341
Plate Corner Releases	307	Hot Rolled Shapes	341
Inactive and Excluded Plates	307	Cold Formed Shapes	341
Plate Local Axes	308	Concrete Shapes	341
Plate/Shell Element Formulation	309	Wood Shapes	341
Plate Modeling Tips	309		

Aluminum Shapes	342
General Shapes	342
Database Files	345
Solution	347
Static Solutions / Stiffness Matrix	347
Dynamic Solutions - Eigenvalues & Mode Shapes	348
Dynamic Solutions - Response Spectra	349
Spreadsheet Operations	351
Moving and Scrolling	351
Spreadsheet Keyboard Commands	351
Selecting Spreadsheet Cells	352
Undoing Operations	352
Redoing Operations	352
Editing Spreadsheets	353
Moving and Copying Cell Contents	354
Sorting and Finding in Spreadsheets	355
Default Spreadsheet Data	356
Special Spreadsheet Functions	356
Stability	358
Instability Procedure	358
Instability Causes	358
Instability Examples	358
Testing Instabilities	361
Unbraced Lengths	363
Lb Values (Lb, Lu, Le)	364
Lcomp Values (Lcomp, Le-bend)	364
L-torque	365
Automated Unbraced Length Commands	366
Material Specific Behavior	367
K Factors (Effective Length Factors)	369
Sway Flags	371
Units	372
Standard Imperial Units	372
Standard Metric Units	372
Units Specifications	373
Wall Panels	374

Drawing Wall Panels	374
Modifying Wall Panels	375
Wall Panel Spreadsheets	377
Wall Panel Editor	379
Wall Panel Local Axes	383
Loading	384
Load Attribution	384
Meshing the Wall Panels	385
Wall Panels - Results	391
Wall Force Results	391
General Wall Detail Report	392
CFS Wall - Design	393
CFS Wall Input	393
General Requirements for Shear Walls	395
General Program Functionality and Limitations	397
CFS Wall - Design Rules	404
Unity Check	404
CFS Wall (Studs)	404
Design Rules - CFS Wall (Fasteners)	404
CFS Wall Results	406
CFS Wall Results Spreadsheets	406
CFS Wall Self Weight	407
CFS Wall Detail Reports	407
Concrete Wall Panel - Design	413
Concrete Wall Input	413
Concrete Design Considerations	414
Concrete Lintel Considerations	419
Concrete Wall Modeling Considerations	420
Concrete Wall - Design Rules	421
Unity Check	421
Concrete Wall (Rebar) Rules	421
Concrete Wall (Cover) Rules	422
Concrete Wall Results	425
Concrete Wall Spreadsheet Results	425
Concrete Reinforcing Spreadsheet Results	425
Concrete Wall Detail Reports	426

Masonry Wall Panel - Modeling	435	Wood Wall Detail Reports	493
Masonry Wall Input	435	Warning Log	509
Masonry Wall Optimization	438	Wood - Database	510
Masonry Wall Panel - Design	442	Wood Database Limitations:	512
Shear Design - In Plane ASD	442	Custom Wood Sizes:	515
Axial Design - ASD	443	Wood - Design	516
Bending Design - ASD	444	Glu-Lams	516
In Plane Design - Strength	446	Custom Wood Materials	517
Unreinforced Masonry Design - ASD	448	Wood Member Design Parameters	518
Unreinforced Masonry Design - Strength ..	449	NDS Adjustment Factors	519
Masonry Lintel Design - ASD	449	CSA O86 Adjustment Factors	522
Masonry Lintel Design - Strength	450	Limitations - Wood Design	523
Masonry Wall - Design Rules	452	NDS Emin Calculation	524
Unity Check	452	Wood Member Code Check Results	524
Masonry Wall General	452	Special Messages - Wood Design	526
Masonry Wall In Plane Design	453	Appendix A – Redesign Lists	527
Masonry Wall Axial Design	454	Design List Mismatch	527
Masonry Wall Lintel Design	454	Locating the Design Lists	527
Masonry Wall Results	456	File Naming Convention for the Design Lists	527
Masonry Wall Spreadsheet Results	456	File Format for Redesign Lists	528
Concrete Reinforcing Spreadsheet Results ..	457	Creating or Modifying Design List	529
Masonry Wall Detail Reports	457	Appendix B – Error Messages	530
Wall Report	458	Appendix E - Interfacing with Other Pro- grams	531
In Plane Masonry Detail Reports	459	Integration with other RISA programs	531
Masonry Detail Reports - Lintels	465	Importing or Exporting DXF Files	531
Wood Wall - Design	468	Structural Desktop	531
Wood Wall Input	468	Appendix F – Wood Shear Wall Files	532
General Requirements for Shear Walls	470	Hold Downs	532
General Program Functionality and Lim- itations	476	Straps	534
Wood Wall - Design Rules	487	Panel Nailing Schedules	535
Unity Check	487	Appendix G – CFS Shear Wall Files	538
Wood Wall (Studs)	487	Panel Nailing Schedules	538
Design Rules - Wood Wall (Fasteners)	488	Technical Support	541
Wood Wall Results	491		
Wood Wall Results Spreadsheets	491		
Wood Wall Self Weight	493		

Before You Begin

Welcome to the RISA-2D General Reference manual. Please read this topic prior to installing the program and pay particular attention to the [License Agreement](#). If you are a first time user of RISA-2D you should turn your attention to the [Tutorials](#) (a separate document) which are designed to get you up and running as fast as possible while still exposing you to the important features of the software.

The [Tutorials](#) are designed to be read in two ways. If you are already familiar with structural modeling in general you can skip the supporting text and read only the underlined action items to quickly move through the tutorial. If you want more thorough explanations of the modeling process you may read all or some of the supporting text as you see fit.

After you have gone through the [Tutorials](#), use this General Reference for detailed information on any topic. The topics are arranged in alphabetical order and are thoroughly indexed.

Overview

RISA-2D is a general-purpose 2-dimensional analysis and design program. This program has been developed to make the definition, solution and modification of 2D structural models as fast and easy as possible. Analysis, up to and including calculation of maximum deflections and stresses, may be done on structures constructed of any material or combination of materials. Complete steel and wood design are also included in the program.

RISA-2D has full graphical modeling capability. You can draw your model on the screen and also perform extensive graphical editing simultaneously in multiple views. To modify your model data directly, RISA-2D employs a powerful, proprietary spreadsheet. All this combined with flexible data generation algorithms makes modeling very easy. Graphic display of the model along with applied loads, boundary conditions and much more, is always available. The model can be rapidly edited, solved, viewed, modified, re-solved, etc. The truly interactive nature of RISA-2D is its primary strength. RISA-2D is also able to perform elaborate error checking as you define the model, and offers context sensitive help every step of the way.

RISA-2D is an *interactive* program as opposed to a *batch* mode program. With a batch mode program, you would edit a text file in one program (typically called a pre-processor), and then solve it with another program, and then view the solution results in yet another program (typically called a post-processor). With RISA-2D, all model editing, model solution, and results browsing is accomplished through the same interface and with the same program. The interactive approach offers several unique advantages over batch mode which include; the ability to do real time error checking of your model data, the ability to do rapid model editing, solution, editing, and re-solution without jumping from one program to another, and the need for the user to learn only one program interface.

You may access the features in RISA-2D by using the menu system, or the toolbars. The best way to learn RISA-2D is to go through the [Tutorials](#). The advantage to this is that you are exposed to the tools RISA-2D provides and the ways that you can take advantage of them.

Minimum System Requirements

One of the following operating systems is required:

- Microsoft Windows 11 (64 bit only)
- Microsoft Windows 10 (64 bit only)
- Microsoft Windows 8.1 (64 bit only)

Internet (Subscription License Only)

An internet connection is required to launch the program. The internet connection must be maintained as long as the program is open, although brief internet outages (a few minutes) do not affect the user's ability to keep the program open.

Hardware

The following hardware is required:

- 1 GHz or faster processor (x86-64)
- 1920x1080 monitor resolution recommended (1024x768 minimum)
- 2 (or more) button mouse, mouse wheel recommended
- 8 GB of RAM
- 4 GB of hard disk space

Program Limits

Software Limitations

1,000 Joints

1,000 Members

1,000 Plates

100 Wall Panels

500 Section Sets

500 Materials

500 Custom Wood Species

1,000 Basic Load Cases

10,000 Loads

500 Moving Loads

5,000 Load Combinations

2,000 Mode Shapes

Demonstration Version: While you can open and solve a larger model, the largest model that can be saved to disk with the demonstration version is limited to 20 Joints, 20 Members, 20 Plates and 1 wall panel.

Also, the Demonstration Version will automatically shut down if left open for 24 continuous hours.

License Agreement

For the full license agreement, please visit: risa.com/eula

Maintenance (Perpetual License Only)

Program maintenance provides all [upgrades](#) to RISA-2D.

When your maintenance expires, you will be given the opportunity to continue program maintenance on an annual basis. You are under no obligation to continue program maintenance, of course, but if you decide to discontinue maintenance you will no longer receive RISA-2D program upgrades and technical support. In the event maintenance is discontinued, reinstatement of maintenance will require payment of an "upgrade" fee.

Complete program support is available to registered owners of RISA-2D and is included in the purchase price. This support is provided for the life of the program. See [Technical Support](#) for a list of your support options.

The “life of the program” is defined as the time period for which that version of the program is the current version. In other words, whenever a new version of RISA-2D is released, the life of the previous version is considered to be ended.

RISA Tech, Inc. will provide technical support only for the current version of RISA-2D.

Application Interface

The [Tutorials](#) (a separate document) contain a tutorial that leads you through the RISA-2D interface with an actual model. Consider going through the tutorial if you have not done so already, as it is the fastest way to learn the program. Although it requires some time up front, the tutorial will save you time and brainpower in the long run.

The features that are available to you in RISA-2D may be accessed through the main menu, shortcut menus, toolbars and shortcut keystrokes. You may use any or all of these vehicles to interact with the software. The main menu has the advantage of containing all of the program options and features and may initially be the simplest to use, letting you learn just one system. The toolbars contain more common options and invoke with one click. The shortcut menus present options relevant to the task at hand. The shortcut keys provide a fast way to access features should you use the program often enough to make them familiar to you. All of these features are discussed in the sections below. There are many ways to access features and the method that you will use will simply be a matter of personal preference. The good news is that you have the options.

The bar along the top of the screen is called the title bar and contains the name of the file that is currently open. The three buttons  on the far right side of the title bar are used to control the main window. The left button will shrink the main application window to a button on the taskbar. The middle button will shrink or maximize the window on your screen. The right button will close the window, prompting you to save changes if necessary. You will also see these buttons in other windows and they have basically the same functions there as well.

The actual work that you do will be in the main area on the screen, which is called the workspace. When you open a model view, a spreadsheet or a dialog it will be opened in the workspace and listed in the **Window** menu. You may have as many windows open as you like.

Main Menu

All of the program features may be accessed through the main menu system at the top of the screen beginning with **File** on the far left and ending with **Help** on the far right. Clicking on each of these menus (listed below) will display sub-menus that contain options that you may choose from. You may also select the main menus by using the ALT key along with the underlined letter in the menu you wish to choose. You may then continue to use the keyboard to choose from the menu options. In addition, some of the menu options will have hot key combinations listed to the right of the option. These hot keys allow you to use the keyboard to access features without using the menu system.

File Menu

New will close the current file, prompting for saving if necessary, and will open a new file.

Open will close the current file, prompting for saving if necessary, and will open an existing file.

Save will save the current file, prompting for a name if necessary.

Save As will save the current file, prompting for a name.

Append will insert another RISA-2D model into the current model.

Import will close the current file, prompting for saving if necessary, and will open an existing DXF file.

Export will export the current file to a DXF or SDNF file.

For more information on the interaction between RISA and other programs refer to [Appendix E](#).

Print will access RISA-2D printing options.

Page Setup will present page setup options for printing.

Recent Files The five most recent files will be listed at the bottom of the menu. Selecting one of these files will close the current file, prompting for saving if necessary, and will open the selected file.

Exit will close RISA-2D, prompting for saving if necessary.

Edit Menu

Undo will undo the last edit that was applied to the model whether it was made graphically or in the spreadsheets. You may continue to apply Undo to remove up to 100 model edits.

Redo will reverse the last undo that was applied to the model. You may continue to apply Redo to remove up to 100 undo operations.

Select All will highlight an entire spreadsheet all at once.

Copy will copy the selected spreadsheet cells or model view from the active window to the clipboard.

Paste will paste data from the clipboard to the spreadsheet cells.

Insert Line will insert a new line in the spreadsheet beneath the current line.

Delete Line will delete the current spreadsheet line.

Repeat Line will insert a new line in the spreadsheet beneath the current line and copy the data from the current line.

Mark All Lines will select all of the lines in the spreadsheet.

Unmark Lines will unmark any currently marked lines.

Delete Marked Lines will delete the marked lines in the spreadsheet.

Find will locate an item on the spreadsheet by its label.

Sort will sort the column containing the active cell.

Fill Block will fill the marked block of cells with a valid entry.

Math on Block allows you to add, subtract, multiply or divide the values in the marked block of cells.

Settings

Settings opens the Model Settings.

Units

Units opens the Units settings.

View Menu

New View will open a new model view window.

Save or Recall Views allows you to save a view or recall a view that has previously been saved.

Clone View makes a copy of the current view so you can modify one and maintain the other.

Refresh All will refresh all of the windows that are open in the workspace.

Select provides graphic select options that are also provided on the **Selection Toolbar**.

Unselect provides graphic unselect options that are also provided on the **Selection Toolbar**.

Save or Recall Selection States allows you to save a selection or recall a selection that has previously been saved.

Zoom provides options for zooming in and out of the current model view.

Rotate provides options to snap the model view to global planes or an isometric view.

Model Display Options opens the Model Display Options.

Render will turn rendering of the current model view on or off, depending on the current setting.

Drawing Grid will turn the display of the Drawing Grid on or off, depending on the current setting.

Axes will turn the display of the global axes in the model view on or off, depending on the current setting.

Boundaries will turn the display of the boundary conditions on or off, depending on the current setting.

Loads will turn the display of the model loads on or off, depending on the current setting.

Joint Labels will turn the display of the joint labels on or off, depending on the current setting. A third setting is also available where the joints themselves are not shown at all.

Member Labels will turn the display of the member labels on or off, depending on the current setting. However, if rendering is turned on, member labels will not be visible in the model view.

Insert Menu

The **Insert Menu** will help you insert new items into the model. Most of the options will provide a graphical method of insertion but some will open spreadsheets where appropriate. See [Graphic Editing](#) for specific information.

Modify Menu

The **Modify Menu** will help you modify existing items in the model. Most of the options will provide a graphical method of modification but some will open spreadsheets where appropriate. The **Delete Items Dialog** may also be accessed via this menu. See [Graphic Editing](#) for specific information.

Spreadsheets Menu

The **Spreadsheets Menu** provides access to any of the input spreadsheets. See [Spreadsheet Operations](#) to learn how to work within the spreadsheets.

Solve Menu

Clicking on the **Solve Menu** will immediately begin a solution to the model. See [Solution](#) for more information.

Results Menu

The Results Menu provides access to any of the results spreadsheets. See [Results Spreadsheets](#) for more information.

Tools Menu

Relabel Joints assigns new labels to the joints in their current order in the **Joint Coordinates** spreadsheet.

Relabel Members assigns new labels to the members in their current order in the **Members** spreadsheet.

Relabel Plates assigns new labels to the plates in their current order in the **Plates** spreadsheet.

Relabel Wall Panels assigns new labels to the wall panels in their current order in the Wall Panels spreadsheet.

Full Model Merge will merge the entire model. See [Model Merge](#) for more information.

Round Off Joint Coordinates will round off the coordinates.

Delete all Wall Panel Regions will delete the regions on all wall panels. The regions will be automatically regenerated next time the model is solved.

Application Settings contain settings that let you customize the program. See [Customizing RISA](#) for more information.

Customize Toolbar allows you to modify the model view toolbar by adding, subtracting and re-ordering buttons. See the [customizable toolbar](#) section.

Reset All Program Defaults will reset all customized settings to the original factory settings.

Window Menu

In order to help you work with the model and the results, you are provided with many window arrangements to choose from. You may access them from the **Window Menu**. The best way to understand just what these 'tilings' do is to try them. Remember that once you choose a tiling you may adjust any of the windows as you wish. You may also use the **Tile**  button on the **RISA Toolbar** to access a list of tilings.

Help Menu

Help Topics opens the RISA-2D Help File so that you may search the contents and the index. See [Help Options](#) to learn about getting help.

Check for Update runs an internal check for possible program updates. If your program is up to date, you will receive a message saying you are up to date. If you are out of date, the check will offer you the option to email RISA Tech, Inc. for upgrade information if you are out of date for a major update. If you are out of date just a minor update, then we will send you to our website to upgrade.. This check is also offered during the installation process.

Licensing gives information about your subscription license and the option to Borrow or Return a license from your subscription.

About provides RISA-2D version and hardware key information.

File Edit Global Units View Insert Modify Spreadsheets Solve Results Tools Window Help Director

Shortcut Menu

The **Shortcut Menu** is also referred to as the **Right-Click Menu**. This is because to access the shortcut menu you simply click the RIGHT mouse button where you are working to see options that are relevant to what you are doing. For example if you are working in a model view the right click menu will provide options to help you modify the view and edit the model graphically. If you are working in a spreadsheet the menu will provide editing tools for that spreadsheet.

This menu will appear wherever you RIGHT click the mouse. This way you do not need to move away from where you are working to select the features you want to use.

Toolbars

The **Toolbars** provide buttons to help you access common commands and popular options in the menu system discussed above. There are different toolbars that will appear as you work to build your model and browse your results. If at any time you are not sure what a particular button does, simply let your mouse hover over the button and a helpful tip will pop up and explain the button.

RISA Toolbar



The first horizontal toolbar located just below the Main Menu is called the **RISA Toolbar**. The buttons on this bar facilitate file and window access. You may use these buttons to open files and windows and also to analyze the model.

Window Toolbar



The **Window Toolbar** is the second horizontal toolbar located below the Main Menu. It gets its name because the buttons change as you move from window to window in order to help you with what you are currently doing. When you are working in a model view the buttons provide viewing tools, such as **Rotate** and **Zoom**, to assist you with that view. There are also many other results and information display toggles, including some icons with the drop down arrow next to them. Clicking the arrow will show you the different view options for that icon. Clicking the icon itself will bring you back to the default view. Note that this model view toolbar is now fully customizable. See below for more information.

Other model view windows that are open will not be affected so that each may show different information. When you are working in a spreadsheet, editing tools are provided that are appropriate to that particular spreadsheet. Note that not all tools are available with all spreadsheets. In fact there are many tools that are provided for one spreadsheet only. See [Spreadsheet Operations](#) for more information.

Note:

-  - This button will allow you to take a snapshot of the current detail report you are viewing so that it can be added to a report. View the [Printing](#) topic for more information.

Customizable Model View Toolbar

The model view toolbar is fully customizable. By creating your personalized toolbar, you can quickly access your most frequently used buttons. This can be done quickly and easily in just a few steps.

1. Go to Tools menu and select Customize Toolbar.

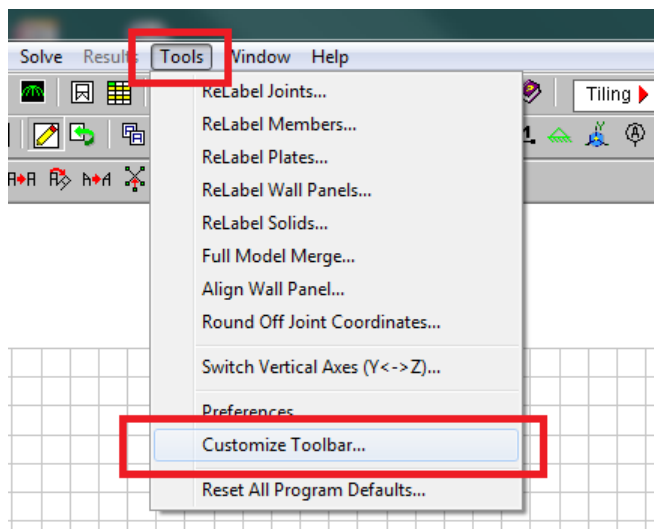

2. Select one of the toolbars by clicking in the box Available toolbar buttons, and click on Add to place them on the current toolbar.

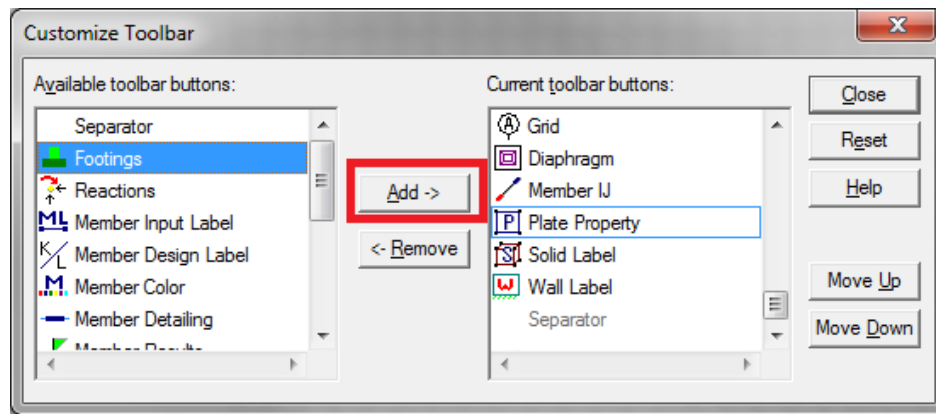

- Once you've moved the buttons to the Current Toolbar, you can rearrange them by clicking on Move Up or Move Down.

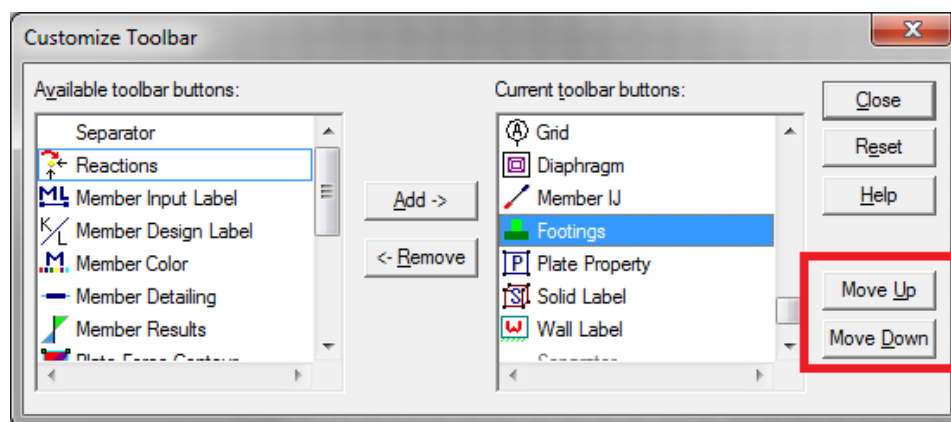

- Click Close and you will see your selections on the model view toolbar.

Note:

- You must have a model view as the current view to see this toolbar.
- If you add more buttons than will fit on the toolbar the buttons that are at the end of the "Current toolbar buttons" will be cut off.
- The changes you have made will automatically be saved on a per-user (Windows User) basis, such that next time you open the program the toolbar will be arranged per your Application Settings. These saved changes are saved in the registry in the HKEY_CURRENT_USER\Software\RISA Technologies**RISAProgram** location with a String Value called "ToolbarState".

Selection Toolbar

The vertical toolbar on the left side of the screen is the **Selection Toolbar**. This toolbar will only be available when the active window is a model view. The buttons on this toolbar help you select and unselect items in the model in order to help you build and modify the model or view results. See [Graphic Selection](#) for more information.





Drawing Toolbar



Another toolbar that is available is the **Drawing Toolbar**. Unlike those mentioned above, this toolbar is located in the model view windows rather than in the main application window. This way the drawing tools stay close to where you are working. This toolbar controls modeling features that help you draw, load, and modify your model graphically. You may have more than one view open and a Drawing Toolbar for each view. This way you can simultaneously draw plates in one window and members in another.

The **Drawing Toolbar** may be displayed in any model view window by clicking  on the **Window Toolbar** while in the model view window. Some of the buttons on the toolbar are for one-time applications such as modifying the drawing grid. Other buttons place you in an editing mode, such as Draw Members, that remains active until you cancel it. The current mode is indicated by the mouse pointer and by the state of the button. While in an editing mode the button will stay down until you click it again or choose another button. See [Graphic Editing](#) for more information.

This brings us to an important point. Some of the toolbar buttons remain down when you press them to indicate that you are in a certain mode or that something is either on or off. For example the **Box Zoom**  button will stay down to indicate that you are currently in the zooming mode. The **Show Drawing Toolbar**  button will remain down when you turn on this toolbar for the active window. You may be in more than one mode at the same time as long as they are not mutually exclusive.

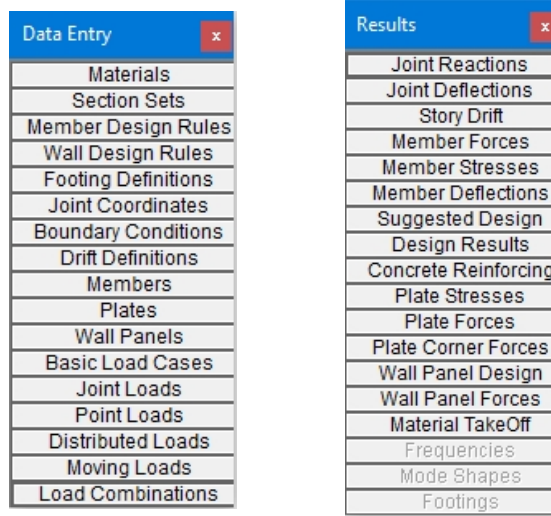

The **Data Entry Toolbar** is the vertical toolbar on the right side of the application window. It contains buttons that facilitate data entry through the spreadsheets. The buttons on this toolbar provide quick access to the spreadsheets that are also listed in the **Spreadsheets Menu**. You may open and close the toolbar by clicking the  button on the **RISA Toolbar**.

For additional advice on this topic, please see the RISA Tips & Tricks webpage at risa.com/post/support. Type in Search keywords: **Data Entry**.

The **Results Toolbar** is the vertical toolbar on the right side of the application window that is placed over the **Data Entry Toolbar** after the model has been solved. The buttons on this toolbar provide quick access to the results spreadsheets that are also listed in the **Results Menu**. You may open and close the toolbar by clicking the  button on the **RISA Toolbar**.

Dynamic View Controls

When your current window is a graphical model view, you can use the mouse wheel to dynamically zoom, pan, or rotate the graphical image.

Mouse Action	Model View Function
Rolling the Wheel Forward	Zoom In
Rolling the Wheel Backward	Zoom Out
Clicking and holding the Wheel Button	Grab the image and pan in the direction of mouse movement
Click and hold the Wheel button while pressing the Shift key	Dynamically rotate the structure in the direction of mouse movement

Dynamic Pan: Clicking and holding the mouse wheel button triggers the tool and allows the user to pan or drag the view to the limit of scroll bars.

Dynamic Zoom: This tool uses the wheel button on the mouse. Rotating forward zooms in and rotating backward zooms out.

Dynamic Rotate: This tool is triggered by clicking and holding the mouse wheel button while holding the Shift key. The rotational movement will be based on the how the user drags the mouse cursor over the screen and the projection of global axis on the screen. For rotation about X axis, drag the cursor perpendicular to the projection of the global X axis. The same logic applies for Y or Z axis rotations. When rotation is initiated, the system locks for rotation about that axis until the user releases the middle mouse button.

Zoom Previous/Next: Function keys F3 and F4 are associated with Zoom Previous and Zoom Next respectively. The system holds a doubly linked list of zoom info. This list has 10 zoom-states in the list. The F3 or F4 keystroke moves the active pointer forward or backward on the list. Each window has its own zoom list.

Dynamic Distance Tool: This tool triggers by pressing the F5 key. The user has to pick up two points on the screen and the system gives back the total and partial distance between points on the status bar.

Shortcut Keys and Hot Keys

Shortcut Keys and **Hot Keys** allow you to use the keyboard to quickly access features. The difference between the two is simply that the shortcut keys are related to a specific window and will only work in that window while the hot keys will perform at most any time.

General Hot Keys

Key Combination	Function
F1	Help on the active window
F5	Activates the Dynamic Distance Tool
Ctrl-F1	Main Help topics
Ctrl-F2	Create New view
F7, Ctrl-F7	Opens solution choices
Ctrl-Alt-F7	Replace shapes with suggested shapes and re-solve the model
Ctrl-C	Copy to the clipboard
Ctrl-V	Paste from clipboard
Ctrl-N	Start a new file
Ctrl-O	Open an existing file
Ctrl-S	Save the current file
Ctrl-P	Print
Ctrl-Z	Undo
Alt-	Access the menus by combining the Alt key with the underlined letter in the menu

Shortcut Keys available for Specific Windows

Key Combination	Model View Window	Spreadsheet
Ctrl-D	Open last graphic editing dialog	Delete Marked Lines
Ctrl-G	Toggle Drawing Toolbar	
Ctrl-A	Select All	Select All
Ctrl-U	Unselect all	
Ctrl-F		Block Fill
Ctrl-M		Block Math

Key Combination	Model View Window	Spreadsheet
Ctrl-I	Invert Selection	
Ctrl-L	Toggle Lock unselected	Unmark lines
Ctrl-Enter		Press cell  button
F2	Open Model Display Options	Start/Stop Cell Edit
F3		Insert line
F4		Delete Line
F5	Initiates the "Distance" tool	Find
F8		Repeat Current Line
+	Zoom In	
-	Zoom Out	
←→↑↓ PgUp PgDwn	Scrolling	Scrolling

Spreadsheet Hot Keys that open spreadsheets







Key Combination	Unsolved Model	Solved Model
Ctrl-Alt-B	Basic Load cases	
Ctrl-Alt-C	Joint Coordinates	Corner Forces
Ctrl-Alt-D	Distributed Loads	Joint Deflections
Ctrl-Alt-E	Members – Primary Data	Member Deflections
Ctrl-Alt-F		Member Forces
Ctrl-Alt-G	Model Settings	
Ctrl-Alt-H	Model Generation	Suggested Shapes
Ctrl-Alt-K		Solid Stresses
Ctrl-Alt-L	Load Combinations	Plate Forces
Ctrl-Alt-M	Materials	Material Take Off
Ctrl-Alt-N	Joint Loads	Concrete Reinforcing
Ctrl-Alt-O	Boundary Conditions	Mode Shapes
Ctrl-Alt-P	Member Point Loads	Plate Stresses
Ctrl-Alt-Q		Frequencies
Ctrl-Alt-R	Design Rules	Reactions
Ctrl-Alt-S	Section Sets	Member Stresses
Ctrl-Alt-T		Story Drift
Ctrl-Alt-U	Seismic Design Rules	Design Results
Ctrl-Alt-V	Moving Loads	
Ctrl-Alt-Y	Dynamics Settings	
Ctrl-Alt-4	Plates	

Status Bar



The **Status Bar** passes useful information to you as you work. It is divided into four parts located along the very bottom of the main application window, just beneath the workspace.

The left side of the status bar shows a solution flag to indicate the solved state of the model as follows:

Solution Type	Unsolved	Solved
Static		
Dynamic		
Response Spectra		

To the right of the solution flags there are three message boxes.

The first and largest box lets you know what you are currently doing. If you are in a spreadsheet, this box will contain the explanation of the current cell. If you are working in a model view and select a graphic editing option, look to this box for information on how to use the feature.

The second box is used to pass you units of the current spreadsheet cell.

The third box indicates the coordinates of the mouse when a model view is active. The mouse coordinates that are displayed are the coordinates of the grid point or joint that is nearest to the mouse.

Windows

Modeling the structure will take place within model views and spreadsheets, each in their own window that may be moved around the workspace and sized as you wish. The ability to have multiple model views and multiple spreadsheets open at one time is a powerful feature. The options in the **Window Menu** are provided to help you manage these windows.

These windows contain three buttons  in the upper right corner to help you minimize, maximize and close the window, respectively. There are also scroll boxes to help you view information that is outside of the window viewing area. Click the scroll bar buttons or drag the scroll box to advance the display in one direction or another.

Model Views

Model View windows show a graphic view of the model. Open a new view with the  button.

You may open as many model view windows as you like. This is especially helpful when working in close on large models. You might have one overall view and a few views zoomed in and rotated to where you are currently working. You may also have different information plotted in multiple views.

One thing to remember is that the toolbars that are displayed depends upon what window is active. The active window is the one with the blue title bar. For example, if you are looking for the zoom toolbar button and the active window is a spreadsheet you need to select a model view first before you can access the zooming tools.

Spreadsheets

Spreadsheet windows are made up of rows and columns of data cells. If you wish to add or edit data in a spreadsheet cell you click on the cell, making it the active cell, and then edit the cell. This active cell is simply the green cell that moves around the spreadsheet as you hit the cursor keys (←, →), Page Up, Page Down, Home, End, etc. There is always one and only one active cell, which is the cell that has the “attention” of the keyboard.

You may also select blocks of data to work on. You can select a block of data by clicking and holding the mouse button on the first cell in the block and then dragging the mouse to the opposite corner of the block and releasing the mouse.

Dialogs

A **Dialog** is a third type of window and is used to access a specific function within the program. Another powerful feature is that most of the dialogs may be left open while you edit the model, making it easy to make adjustments as you work. You will find that dialogs are very easy to work with. There are **Help** buttons that will bring you directly to the relevant topic in the help file.

Window Tiling

Standard window tilings help you set up your workspace. Select the **Tile**  button and then select a tiling or choose them from the **Window ▶ Special Tiling** menu.

The standard tilings include arrangements of spreadsheets and model view windows for creation of models and viewing results. Each of these groups have arrangements for working with joints, members, and plates and also loads. The best way to learn what these tilings do is to try them.

Modes

There are three basic program modes (**View**, **Select**, and **Edit**) and a mode hierarchy to allow you to move between them easily. While you are **editing** the model you may **select** items to edit. When you are finished **selecting** you will be returned to **editing**. Likewise, while you are **selecting** items you can adjust the **view** and then be returned to **selecting**.

Different mouse cursors are used with each mode to make it clear what the current mode is.

View Mode is the upper level mode that allows you to adjust the view by zooming in and out, rotating and setting Model Display Options. This mode supersedes all other modes so that you may do these things at any time, and then be returned to the previous mode. This mode does not cancel other modes so that when you are finished adjusting the view you are returned to what you were doing. See [Graphic Display](#) for more information.

Select Mode is the middle level mode that allows you to make a graphic selection of joints, members and plates. This mode supersedes the **Edit Mode** but not the **View Mode**. This means that you can make a selection while in the middle of editing the view and when you are finished you are returned to the editing feature that you were using. It also means that you may adjust the view while remaining in the same **Select Mode**. See [Graphic Selection](#) for more information.

Edit Mode is the lower level mode that allows you to graphically edit the model. You may make selections and adjust the view while in the edit mode such that when you are finished selecting you will be returned to the **Edit Mode**. Some **Edit Mode** features have options on how you apply the edit. See [Graphic Editing](#) for more information.

Note

- The default mode is the mode you are in if you are not in any other mode and is indicated by the standard  mouse cursor. The default mode is a selection mode where you can select/unselect individual items by clicking on them. You may also double-click on an item to view information about the item.
- You may use the ESC key or the right mouse button to cancel a mode.

Aluminum - Databases

Shapes are organized in the database by country. The shapes available are from the ADM 2005 Section Properties section. You may type in the names directly, select shapes from these databases or add your own shapes.

RISA currently supports the following common Cold Formed steel databases: Aluminum US, and Aluminum CAN.

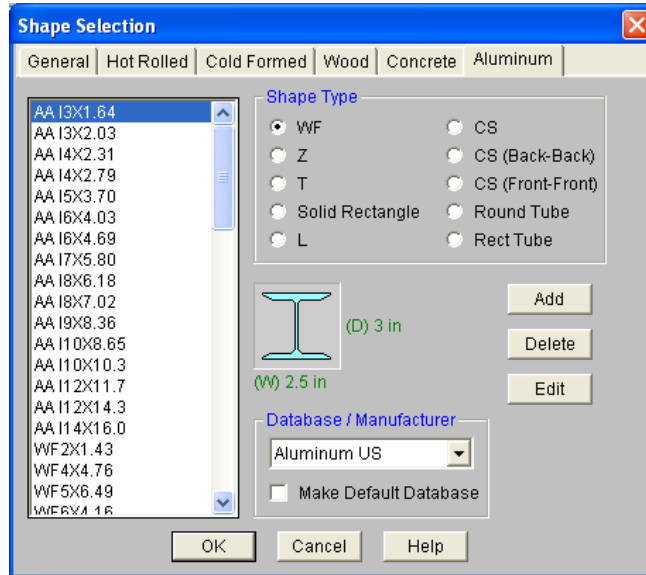

To Select a Cold Formed Database Shape

1. From the **Aluminum** tab on the **Section Sets Spreadsheet**, or the **Primary** tab of the **Members Spreadsheet** move the cursor to the **Shape** field and click .
2. Specify the Database and Shape Type you wish to use and then select from the list of available shapes by clicking on .

Database Files

The aluminum shape databases are stored in the files ADMdbUS32.fil and ADMdbCAN32.fil.

To Add a Database Shape

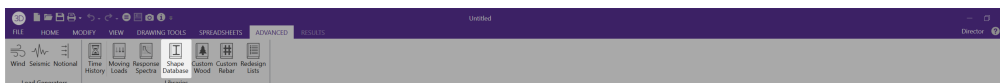

1. On the **RISA Toolbar** click the **Edit Shape Database**  button.
2. Select the **Aluminum** tab, then select the shape type you wish to add and click the **Add** button.
3. Specify a name for the shape and fill in the **Basic Properties**.
4. Click **Calc Props** to determine the shape properties.

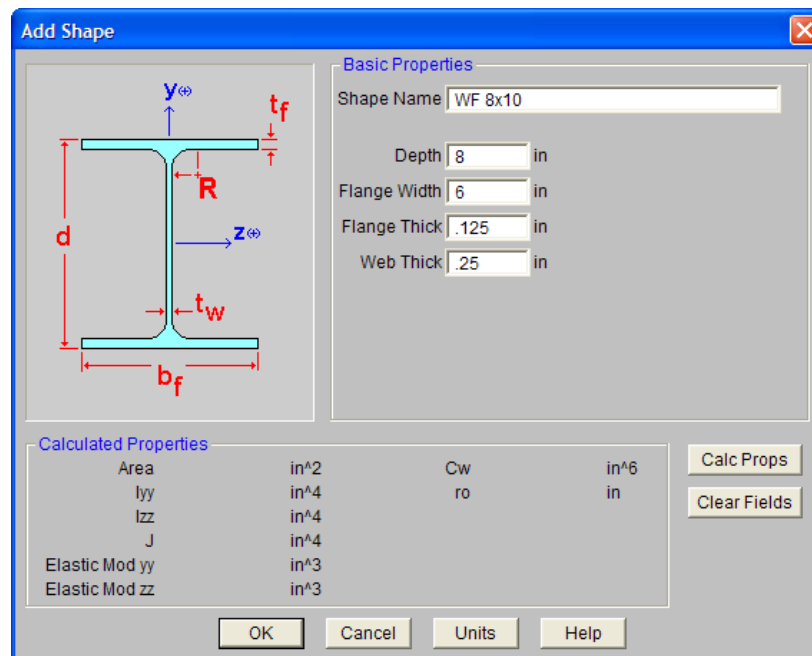

Note

- Alterations to the shape database are not permanent unless you agree to save them. Changes that are not saved only remain valid for the current session and will not be present the next time you start RISA.
- New shapes are added to the bottom of the database.
- To delete a shape, specify the database and shape type you wish to delete and then click the **Delete** button.
- To edit a shape, click the **Edit** button and edit the shape properties. Values can only be manually edited here, nothing will be recalculated. If you wish to have all the values for a shape recalculated, you will need to delete the shape and then add it again with the new properties.

Aluminum Shape Types

There are ten types of aluminum shapes. Names for each shape type follow the convention of the manufacturer for each shape. If you know the shape name, you can type the name directly into the **Shape** field on the spreadsheets. Alternatively, you may click the  button to look up a shape and select it.

WF sections

The wide flange shapes are called out by the designation given them in the aluminum manual. For example, if you wanted to use a WF10x11.4 you would enter WF10X11.4 as the shape name in the database shape field. Aluminum Association Standard I-Beams(AA), American Standard(S), Army-Navy(A-N), Canadian(CAN) I-Beams and Wide Flange shapes are available.

Zee sections (Z)

The Z shapes are called out by the designation given them in the ADM manual.

Tee sections (T)

The T shapes are called out by the designation given them in the ADM manual. Army-Navy (A-N) shapes are also available.

Solid Rectangular

The Solid Rectangular sections or bar sections are defined by the user, there are no default shapes.

Angles sections (L)

Angles are entered with an "L" prefix. The syntax is "longXshortXthick", where "long" is the long leg length, "short" is the short leg length, and "thick" is the thickness, in number of decimals. For example, L5X3X0.375 is a 5" by 3" angle 0.375" thick. Square End Angles (LS) shapes are also available.

Channel sections (CS)

The CS shapes are called out by the designation given them in the ADM manual. The Aluminum Association (AA), American Standard Channels (C) and Car and Ship Building Channels (CS), Canadian Channels (CAN) are available.

Double Sections

The CS shapes are also available Back-to-Back or Front-to-Front orientation.

Note

- The program currently only performs an analysis of double sections and does not perform a code check of any kind. This may be added into a future version of the program.

Round Tube or Pipe (OD or NPS)

The Round Tube shapes are called out by the designation given them in the ADM manual. The Outer diameter call out is used as well as the Nominal Pipe Size.

Rectangular Tube sections (RT)

The RT shapes are called out by the designation given them in the ADM manual.

Aluminum - Design

Full code checking can be performed on standard aluminum shapes, based on the following codes:

- Aluminum Design Manual 2015: Building and Bridge
- Aluminum Design Manual 2010: Building and Bridge
- Aluminum Design Manual 2005: Building and Bridge

Aluminum properties are available in the database and the values are based on the ADM values (See [Aluminum Database](#)). You may also input your own basic shapes and the properties will be calculated automatically.

Design Parameters

The **Aluminum** tab on the **Member Spreadsheet** records the design parameters for the aluminum code checks. These parameters may also be assigned graphically. See [Modifying Member Design Parameters](#) to learn how to do this.

	Label	Shape	Length...	Lb-out[ft]	Lb-in[ft]	Lcomp top...	Lcomp bot...	K-out	K-in	Cb	Welded?	Function
1	M1	T(A-N)6.00X8	5.657	2	2	2	2	1.2	1.2		<input checked="" type="checkbox"/>	Lateral
2	M2	AL1	5.657	2							<input checked="" type="checkbox"/>	Lateral
3	M3	AL2	5.657	2	2	2	2				<input checked="" type="checkbox"/>	Lateral
4	M4	AL3	5.657								<input type="checkbox"/>	Lateral
5	M5	AL4	5.657								<input type="checkbox"/>	Lateral

These parameters are defined for each aluminum member. The entries are explained below.

Label

You may assign a unique **Label** to all of the members. Each label must be unique, so if you try to enter the same label more than once you will get an error message. You may relabel at any time with the **Relabel** options on the **Tools** menu.

Shape

The member **Shape** or Section Set is reported in the second column. This value is listed for reference only and may not be edited as it is dictated by the entry in the Section/Shape column on the **Primary** tab.

Length

The member **Length** is reported in the third column. This value may not be edited as it is dependent on the member end coordinates listed on the **Primary Data** tab. It is listed here as a reference for unbraced lengths which are discussed in the next section.

Unbraced Length

See the [Unbraced Lengths](#) topic.

K Factors (Effective Length Factors)

See the [Unbraced Lengths](#) topic.

Sway Flags

See the [Unbraced Lengths](#) topic.

Cm - Interactive Bending Coefficient

Cm Coefficients are described in Section 4.1.1 of the ADM code. If these entries are left blank, they will be automatically calculated.

The **Cm** value is influenced by the sway condition of the member and is dependent on the member's end moments, which will change from one load combination to the next, so it may be a good idea to leave these entries blank.

Note:

- Cm only shows up in the spreadsheet for the 2005 codes.

Cb - Bending Coefficients

For the aluminum codes, **Cb Coefficients** depends on the moment variation over the unbraced length as described in ADM Chapter F. If this entry is left blank, it will be calculated automatically.

Function for Stiffness Reduction

The **Function** entry may be set to either 'Lateral' or 'Gravity' using the drop down list in the spreadsheet. If the Adjust Stiffness option is set to Yes on the Codes tab of the Model Settings Dialog, then all members with a 'Lateral' Function will be considered for the stiffness reduction required per the Chapter C.2 Calculations of Required Strength.

The **Flexural Stiffness Reduction** of the Direct Analysis Method will be applied to all 'Lateral' members whose member type is set to either 'Beam' or 'Column' on the Primary Tab of the Members Spreadsheet.

The program can perform an iterative analysis during the solution depending on the value of τ_b . In this case, the stiffness matrix is recomputed for each iteration until the value of τ_b converges within 1 percent for all 'Lateral' members in compression. In the unlikely event that τ_b is less than zero, the value of τ_b is considered to be 1.e-5.

When the users sets the Adjust Stiffness flag on the [Model Settings](#) to **Yes (Tau =1.0)**, then the program will use a Tau of 1.0 in the stiffness analysis and no iteration of the stiffness matrix is necessary. This option is a good feature for models which take a long time to solve or which have not yet been proportioned to control drift.

The **Axial Stiffness Reduction** of the Direct Analysis Method will be applied to all 'Lateral' members whose member type is set to either 'Column' or 'VBrace' on the Primary Tab of the Members Spreadsheet.

Note

- The stiffness reduction required by the Chapter C will be ignored if the Adjust Stiffness option is not selected on the [codes](#) tab of the **Model Settings**, or if the design code chosen does not have an option for stiffness reduction.

Aluminum Code Check

Access the **Code Check** spreadsheet by selecting the **Results** menu and then selecting **Members ▶ Design Results** or by clicking on the **Design Results** button on the Results toolbar.

20 Member ADM 05 ASD Aluminum Code Checks (By Combination)														
Hot Rolled Steel Cold Formed Steel Wood Concrete Beams Concrete Columns Aluminum														
	L...	Member	Shape	UC Max	Loc(ft)	Shear UC	Loc(ft)	Ft[ksi]	Fc[ksi]	Fb[ksi]	Fs[ksi]	Cb	Cm	Eqn
1	11	M1	US S12X17.3	.092	8	.005	0	9.697	6.467	7.879	5.599	1	.85	4.1.1-3
2	11	M2	US S12X17.3	.090	8	.002	0	9.697	5.786	7.879	5.599	2.147	.458	4.1.1-3
3	11	M3	US S12X17.3	.052	8	.002	0	9.697	6.627	7.879	5.599	1	.333	4.1.1-3
4	11	M4	RT5X8X0.375	.301	10	.083	10	9.091	6.052	9.091	5.249	2.282	.994	4.1.2-1
5	11	M5	RT5X8X0.375	.022	0	.003	0	9.091	6.31	9.091	5.249	2.794	.957	4.1.1-3
6	11	M6	RT5X8X0.375	.072	2.292	.039	0	9.091	7.602	9.091	5.249	1.261	.6	4.1.2-1

The final results of the code checking are the code check values **UC Max** and **Shear UC**. So, if this value is less than 1.0, the member passes. If it is greater than 1.0, the member fails. If the value is greater than 9.999 it will be listed as "9.999". The Shear Check is based on f_s/F_s . The **Loc** field tells at what location the maximum code check occurs measured from the I-joint location of the member. See [Model Display Options - Members](#) to learn how to view the code check results graphically.

The remaining columns provide some of the values used in the code check with the equation number itself given in the last column. The [Member Detail Report](#) gives more values used to perform the code check.

The final field lists the controlling equation for the code check. This will be one of the equations from Section 4.

For enveloped results the combination that produced the listed code and shear checks is given in the column "lc". The other values are the corresponding values and are not necessarily the maximums across all the combinations.

The moving load results are enveloped and the governing load combination and step location is shown for each result value under the "LC" column. The first number is the load combination, the second is the step number: (load combination - step number). See [Moving Loads](#) to learn more.

Note

- The program currently only performs an analysis of double sections and does not perform a code check of any kind.
- The [Member Detail Report](#) gives more values used to perform the code check.
- See [Spreadsheet Operations](#) to learn how to use **Find**, **Sort** and other options.
- See [Model Display Options - Members](#) to learn how to plot member results.

Aluminum Detail Report

The aluminum detail report has design information for the specific code checks:

AA ADM1-15: ASD - Building Code Check

Max Bending Check	0.998	Max Shear Check	0.014 (y)
Location	0 ft	Location	0 ft
Equation	H.1-1	Max Defl Ratio	L/425

	Slender. Limit	Slender. Ratio	Gov Eqn	Lb KL/r	y-y 10 ft 123.946	z-z 10 ft 47.468	
	λ_1	λ_2	λ				
Pnt/om	38.691 k						
Pnc/om	13.02 k	143.7	123.9	D.2-1	L Comp Top	10 ft	
Mny/om	1.596 k-ft	12.4	32.9	4.6	B.5.5.2	L Comp Bot	10 ft
Mnz/om	4.353 k-ft		143.7	63.6	F.4	Torque Length	10 ft
Vny/om	7.331 k	46.6	121.9	25.2	G.1-1	Cb	1.5
Vnz/om	16.291 k	46.6	121.9	11.4	G.1-1		

The **Max Bending Check** is based on ADM Chapter H, with the governing **Equation** and **Location** listed.

The **Max Shear Check** is not provided in the ADM specification, this represents f_s/F_s with the governing **Location** listed.

The **Max Defl Ratio** is based on the entire length of the member.

The **Slender Limit** λ_1 and λ_2 are calculated based on the **Gov Eqn**. The Slenderness Ratio are given based on the Design Aids in Tables 2-x ADM Section VI. The **Slender. Ratio** is also based on the **Gov Eq**, for further information refer to the ADM Design Aids.

Assumptions and Limitations

For all shape types, it is assumed that the transverse load on the member is occurring through the member's shear center. This means secondary torsional moments that may occur if the load is not applied through the shear center are not considered.

- **Single Angles** are not checked for bending in the 2005 and 2010 codes. They are checked for bending in the 2015 and newer codes.
- r_{ye} , effective radius of gyration from Eq 4.9.1-1 is used for doubly symmetric sections beams.
- **Welded** regions are not checked in RISA-3D. You can use the welded material properties for the entire member, or create segments that are welded material in order to check the weld properties. For additional advice on this topic, please see the RISA Tips & Tricks webpage at risa.com/post/support. Type in Search keywords: **Welded Aluminum**.
- **Connections** are not checked, including web crippling, fatigue or stiffeners.
- **Kt** is assumed to be the smaller of **K-out** or **K-in**.
- **Double Sections** - The program currently only performs an analysis of double sections and does not perform a code check of any kind.

Special Messages

Aluminum Code Check Not Calculated

This message is displayed when the member is not defined with a database shape, is defined as a double section, or an Aluminum code is not specified on the **Model Settings**, or no units were specified.

-Pu was ignored in the calculation of the unity check-

This message is reported in the detail report when the member axial force is low (less than 5% of capacity). This is done so that beam members with very low axial forces will give similar code checks whether in tension or compression.

Boundary Conditions

Boundary Conditions define how the model is externally constrained. All models must be attached to some external point or points of support. You may define these points of support as completely restrained or as partially restrained with a **Spring**. You can also define a spring support that has stiffness in only one direction with tension-only or compression-only springs.

For additional advice on this topic, please see the RISA Tips & Tricks webpage at risa.com/post/support. Type in Search keywords: **Boundary Conditions**.

Creating and Modifying Boundary Conditions

There are a number of ways to create or modify boundary conditions. You may view and edit the data in the **Boundary Conditions Spreadsheet**, you may double-click a joint to view and edit its properties, or you can use the **Modify Boundaries** tool to graphically assign or modify a possibly large selection of boundary conditions.

Modify Boundary Conditions for Joints

The graphical **Modify Boundary** tool discussed here lets you specify and modify boundary conditions graphically. To use this, you will typically specify the new boundary condition, then select the joints that you want to assign or modify.

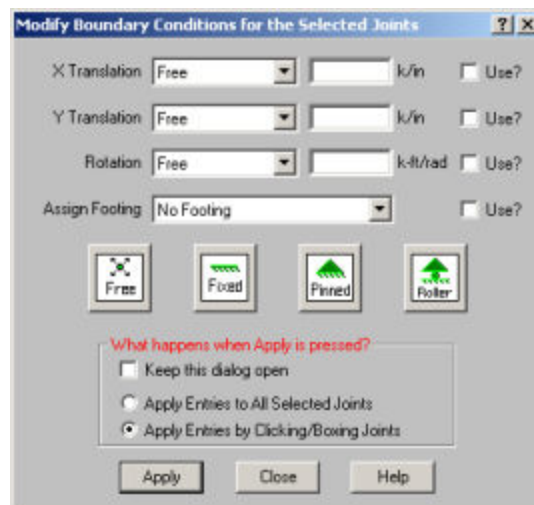

You can modify or assign joints one at a time by selecting the **Apply by Clicking/Boxing** option and then click on the joints you wish to modify. You may also modify or assign entire selections of joints by selecting the joints first and then use the **Apply to All Selected** option.

The parameters shown below are the same as those on the **Boundary Conditions Spreadsheet** and are described in [Boundary Condition Options](#). Use the arrow buttons to select the boundary condition.



The **Use?** check boxes next to the data fields indicate whether the particular parameter will be used or not when the modification is applied. If the box next to a field is checked, that parameter will be applied to any selected joints. If the box is NOT checked, the parameter will NOT be applied, even if a value is entered in the field. This lets you easily change one or two parameters on joints without affecting all the rest of the parameters.

To Apply Boundary Conditions

1. If there is not a model view already open, click  on the **RISA Toolbar** to open a new view and click  to turn on the **Drawing Toolbar** if it is not already displayed.
2. Click the

 **Boundary Conditions** button on the **Home** tab and define the boundary condition. Check the **Use?** Box for the items to apply.

- You may apply the boundary condition by choosing joints on the fly or apply it to a selection of joints.

To choose joints on the fly, choose **Apply Entries by Clicking/Boxing Joints** and click **Apply**. Click/Box the joints with the left mouse button.

To apply the boundary condition to a selection of joints, choose **Apply Entries to All Selected Joints** and click **Apply**.

Note

- To apply more boundaries with different conditions, press CTRL-D to recall the **Boundary Conditions Dialog**.
- You may also view and edit boundary conditions by double-clicking on a joint.
- You may also specify or edit boundary conditions in the **Boundary Conditions Spreadsheet**.
- You may undo any mistakes by clicking the **Undo**  button.

Boundary Conditions Spreadsheet

The **Boundary Conditions Spreadsheet** records the boundaries for the joints and may be accessed by selecting **Boundary Conditions** on the **Spreadsheets Menu**.

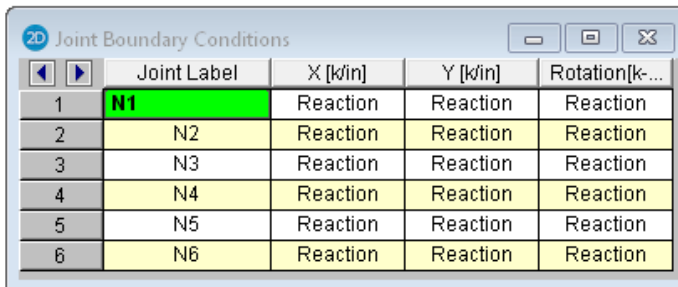

	Joint Label	X [k/in]	Y [k/in]	Rotation[k...]
1	N1	Reaction	Reaction	Reaction
2	N2	Reaction	Reaction	Reaction
3	N3	Reaction	Reaction	Reaction
4	N4	Reaction	Reaction	Reaction
5	N5	Reaction	Reaction	Reaction
6	N6	Reaction	Reaction	Reaction

The **Joint Label** column contains the label of the joint that is restrained.

The remaining columns record the boundary conditions that apply to the joint. There are three degrees of freedom for each joint (2 translation, 1 rotation), so there are three columns for degrees of freedom. The boundary conditions are entered in these remaining columns by selecting the cell, clicking  and choosing from the boundary options. You may also type them in directly.

Boundary Condition Options

Free joints have no restraint in any of the degrees of freedom and need not be listed on the **Boundary Conditions Spreadsheet**. The following are the valid boundary condition options that may be used for the three degrees of freedom.

Note

- Models that contain compression-only or tension-only springs must be iterated until the solution converges. Convergence is achieved when no more load reversals are detected in the springs. During the iteration process, each spring is checked, and if any springs are turned off (or back on), the stiffness matrix is rebuilt and model is resolved. This can take quite a bit longer than a regular static solution.
- With this iteration procedure it is possible to run into a phenomenon known as "clapping". This occurs when a compression-only spring keeps going between a tension force present (where the spring is removed) to a compression force present (where the spring is re-added). This can be somewhat

common in non-linear solutions. If you run into this phenomenon, you may see the program give Error 1162. The fix is to very slightly adjust either the loading or the spring/element stiffness to get the offending spring out of the range where it can bounce back and forth. Another option would be to move the location of the soil spring slightly so it's not right at an inflection boundary.

- You can enter the first letter of the option ("R" for Reaction, "S" for Spring, etc.) rather than typing out the entire code. RISA-2D fills in the rest automatically. The exception is the Tether entry, where the full word does have to be entered. After Tether, the primaryjoint needs to be entered (for example, Tether N2)

Boundary Condition at ALL Joints

The entry "ALL" may be entered in the **Joint Label** field. The boundary conditions entered on this line will be applied to ALL the joints not otherwise listed. This is useful if you should want to lock certain directions of movement for all or most of the joints.

Note

- If a joint is explicitly listed with boundary conditions, those boundary conditions override the "ALL" conditions for all 3 directions. The "ALL" specified boundary codes apply only to those joints NOT otherwise listed on the **Boundary Conditions Spreadsheet**.
- When using the "ALL" command, boundary conditions are no longer graphically displayed.

Reaction Boundary Condition

The "R" code, for **Reaction**, specifies full restraint for the indicated direction. No movement will be allowed in the indicated direction for this joint. Furthermore, the reaction will be calculated at this joint, for this direction.

Fixed Boundary Condition

The "F" code, for **Fixed**, specifies full restraint for the joint in the indicated direction. The difference between "Fixed" and "Reaction" is that for the "Fixed" code, no reaction is calculated. The "Fixed" condition actually removes the degree of freedom from the solution, which is why the reaction value is not available. If you aren't interested in the reaction value, using the "Fixed" code will result in a slightly smaller model and less output.

Spring Boundary Condition

The "Snnn" code, for **Spring**, models a spring attached to the joint in the indicated direction. The "nnn" portion of the code is the numerical magnitude of the springs' stiffness. The units for the spring stiffness depend upon whether the spring is translational or rotational. The appropriate units are shown at the top of the column.

For example, if a spring of stiffness 1000 Kips per Inch were desired in the X direction at a particular joint, for that joint you would enter 'S1000' for the X direction boundary condition.

Compression-Only Springs

The "CSnnn" code, for **Compression-Only Springs**, models a one way "compression-only" spring attached to the joint in the indicated direction. This spring has stiffness for negative displacements and NO stiffness for positive displacements. The "nnn" portion of the code is the numerical magnitude of the springs' stiffness. The spring stiffness units are the same as those for a normal spring. Compression-only springs are useful as soil springs when analyzing foundations that may have uplift.

For example, if a compression-only (CS) spring with a stiffness of 500k/in were desired in the Y direction at a certain joint, you would enter 'CS500' for the Y direction boundary condition.

This means that all displacements at this joint in the negative Y direction will be resisted with a stiffness of 500k/in. However, the joint is free to move in the positive Y direction.

- When a model contains T/C only springs, the program must iterate the solution until it converges. Convergence is achieved when no more load reversals are detected in the T/C only springs. During the iteration process, each T/C only boundary condition is checked. If any springs are turned off (or turned back on), the stiffness matrix is rebuilt and model is resolved. For models with lots of T/C only elements, this can take a bit longer than a regular static solution.

Tension-Only Springs

The "TSnnn" code, for **Tension-Only Springs**, models a one way "tension-only" spring attached to the joint in the indicated direction. This spring has stiffness for positive displacements and NO stiffness for negative displacements. The "nnn" portion of the code is the numerical magnitude of the springs' stiffness. The spring stiffness units are the same as for a normal spring.

For example, if a tension-only (TS) spring with a stiffness of 500k/in. were desired in the Y direction at a certain joint, you would enter 'TS500' for the Y direction boundary condition.

This means that all displacements at this joint in the positive Y direction will be resisted with a stiffness of 500k/in. However the joint is free to move in the negative Y direction.

- When a model contains T/C only springs, the program must iterate the solution until it converges. Convergence is achieved when no more load reversals are detected in the T/C only springs. During the iteration process, each T/C only boundary condition is checked. If any springs are turned off (or turned back on), the stiffness matrix is rebuilt and model is resolved. For models with lots of T/C only elements, this can take a bit longer than a regular static solution.

Tethered Joints

You may tether any or all of the joint degrees of freedom to another joint. See [Tethering Joints](#) for more information.

Story Drift Joints

- The **Boundary** spreadsheet is also used to record joints to be used for story drift calculation. For example, to indicate that a particular joint is to represent the fourth story level for X direction drift, you would enter "STORY 4" for the X direction boundary condition for the joint. These STORY entries may only be made in the translation degrees of freedom. See [Drift](#) for more information.

Boundary Conditions at Wall Panels

If the edge of a wall panel is to be viewed as continuously pinned or fixed, then the boundary condition for that wall must be set in the [wall panel editor](#). Situations can arise where there is a difference between the wall panel edge boundary condition and the boundary condition defined at a joint along that edge. In these situations the joint boundary condition will always govern for that joint. However, the rest of the edge will be based on the wall panel's boundary conditions.



Cold Formed Steel - Databases

Shapes are organized in the database by manufacturer. Common shapes are supported such as C sections(with and without lips), Z sections(with and without lips), and Hat sections(without lips). Each of these shape types may be used as Single section, a Back-to-Back section, or a Face-to-Face section. You may type in the names directly, select shapes from these databases, or add your own shapes.

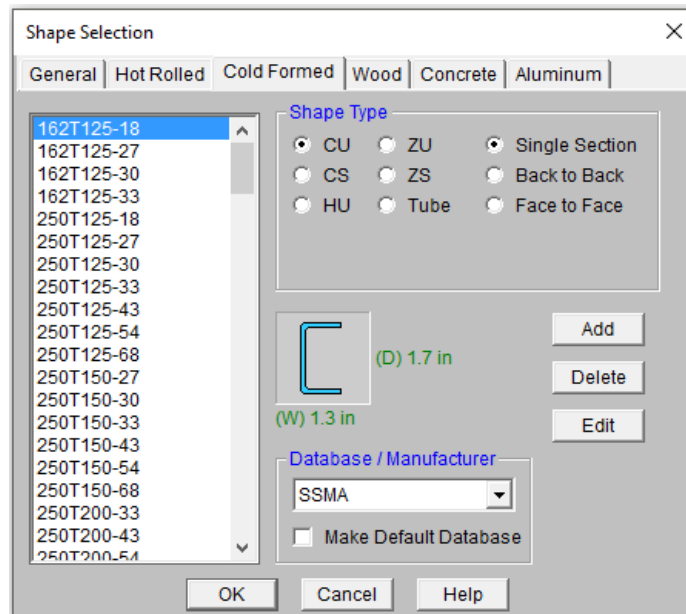
RISA currently supports the following common Cold Formed steel databases: AISI 2007, Dale-Incor, Dietrich, Marino-Ware, and SSMA.



To Select a Cold Formed Database Shape

1. From the **Cold Formed** tab on the **Section Sets** spreadsheet, or the **Primary** tab of the **Members Spreadsheet**, move the cursor to the **Shape** field and click .
2. Specify the database and shape type you wish to use and then select from the list of available shapes by clicking on .

Custom vs. Manufacturer Shapes

You can enter your own cold formed shapes as well as use those provided in the manufacturer database. When the cold formed database type is selected, you'll notice a "Manufacturer" list box that appears in the Shape Selection dialog. You can specify a manufacturer or choose "Custom" to select, add or edit your own custom shapes. New shape properties are calculated using the linear method described in Part I of the AISI code.

Database Files

The cold formed manufacturer shape databases are stored in the file aisidb32.fil, and the custom cold formed shapes are stored in the file aiscust.fil.

To Add a Database Shape

1. On the **RISA Toolbar** click the **Edit Shape Database**  button.
2. Select the **Cold Formed** tab, then select the shape type you wish to add and click the **Add** button.
3. Specify a name for the shape and fill in the **Basic Properties**.
4. Click **Calc Props** to determine the shape properties.

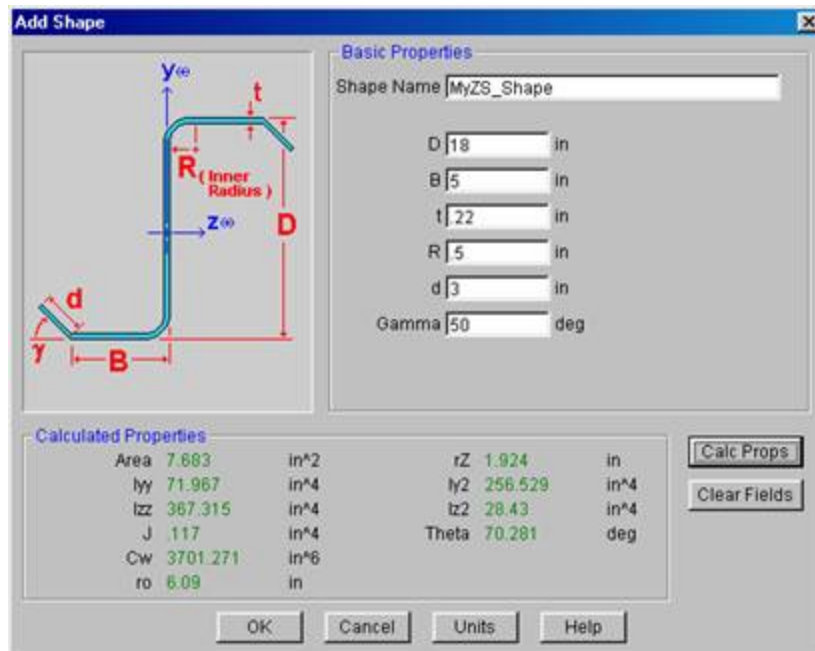

Note

- Alterations to the shape database are not permanent unless you agree to save them. Changes that are not saved only remain valid for the current session and will not be present the next time you start RISA.
- New shapes are added to the bottom of the database.
- To delete a shape, specify the database and shape type you wish to delete and then click the **Delete** button.
- To edit a shape, click the **Edit** button and edit the shape properties. Values can only be manually edited here, nothing will be recalculated. If you wish to have all the values for a shape recalculated, you will need to delete the shape and then add it again with the new properties.

Cold Formed Shape Types

There are five types of shapes. Names for each shape type follow the convention of the manufacturer for each shape. If you know the shape name, you can type the name directly into the **Shape** field on the spreadsheets. Alternately you may click the  button to look up a shape and select it.

C sections without lips (CU)

For the AISI database, CU shapes are called out by the designation given them in the AISI steel manual. For example, if you wanted a 12" deep unstiffened C section, you'd call it out as 12CU1.25x071. The '12' is the depth, the CU specifies a C section without lips, the '1.25' is the flange width, and the '071' is the decimal thickness. Other manufacturer databases generally follow similar conventions.

C sections with lips (CS)

For the AISI database, CS shapes are called out by the designation given them in the AISI steel manual. Other manufacturer databases generally follow similar conventions.

Z sections without lips (ZU)

For the AISI database, ZU shapes are called out by the designation given them in the AISI steel manual. Other manufacturer databases generally follow similar conventions.

Z sections with lips (ZS)

For the AISI database, ZS shapes are called out by the designation given them in the AISI steel manual. Other manufacturer databases generally follow similar conventions.

Hat sections without lips (HU)

For the AISI database, HU shapes are called out by the designation given them in the AISI steel manual. Other manufacturer databases generally follow similar conventions.

Closed Box Members (Tube)

For the AISI database, HU shapes are called out by the designation given them in the AISI steel manual. Other manufacturer databases generally follow similar conventions.

Double Sections

For each of the five shape types the selected shape may be used as a standard single section or as a double section. The choices for double sections are Back-to-Back and Face-to-Face. A typical double section is designated with a "2-" preceding the shape name and a "-BB" (Back-to-Back) or "-FF" (Face-to-Face) following the shape name. For example, a "2-12CU1.25x071-FF" section represents two 12" deep C sections with 1.25" wide flanges and a 0.071" thickness placed face-to-face.

Cold Formed Steel - Design

Full code checking can be performed on standard cold formed steel shapes, based on the following codes:

- The 1996 edition of the AISI code with 1999 Supplement (AISI-99 ASD and LRFD)
- The 2001 edition of the AISI code (AISI NAS-2001 ASD and LRFD)
- The 2001 edition of the Mexican code (CANACERO-2001 ASD and LRFD)
- The 2001 edition of the Canadian code (CSA S136-01 LSD)
- The 2004 Supplement of the AISI code (AISI NAS-2004 ASD and LRFD)
- The 2004 Supplement of the Mexican code (CANACERO-2004 ASD and LRFD)
- The 2004 edition of the Canadian code (CSA S136-04 LSD)
- The 2007 edition of the AISI code (AISI S100-2007 ASD and LRFD) including Supplement No.1 (August 09)
- The 2007 Supplement of the Mexican code (CANACERO-2007 ASD and LRFD) including Supplement No.1 (August 09)
- The 2007 edition of the Canadian code (CSA S136-07 LSD)
- The 2010 edition of the AISI code (AISI S100-10 ASD and LRFD contained in the Supplement No. 2 February 2010)
- The 2010 Supplement of the Mexican code (CANACERO-2010 ASD and LRFD contained in the Supplement No.2 February 2010)
- The 2010 edition of the Canadian code (CSA S136-10 LSD contained in the Supplement No.2 February 2010)
- The 2012 edition of the AISI code (AISI S100-12 ASD and LRFD)
- The 2012 edition of the Canadian code (CSA S136-12 LSD)
- The 2012 edition of the Mexican code (CANACERO-2012 ASD and LRFD)
- The 2016 edition of the AISI code (AISI S100-16 ASD and LRFD)
- The 2016 edition of the Canadian code (CSA S136-16 LSD)
- The 2016 edition of the Mexican code (CANACERO-2016 ASD)

Note:

- Back to Back and Face to Face member checks are available for AISI S100-07 and newer.
- Unless otherwise specified, all code references below are to AISI S100-16.

Cold formed shape properties are available in the database and the values are based on the AISI or manufacturer values, whichever is selected (See [Cold Formed Steel Database](#)). You may also input your own basic shapes and the properties will be calculated automatically.

Design Parameters

The **Cold Formed** tab on the **Members Spreadsheet** records the design parameters for the cold formed steel code checks. These parameters may also be assigned graphically. See [Modifying Member Design Parameters](#) to learn how to do this.

	Label	Shape	Length[m]	Lb-out[m]	Lb-in[m]	Lcomp top...	Lcomp bot...	K-out	K-in	Cm	Cb	R	Out s...	In sw...
17	M17	column	10										<input type="checkbox"/>	<input type="checkbox"/>
18	M18	column	10										<input type="checkbox"/>	<input type="checkbox"/>
19	M19	brace1	12.5										<input type="checkbox"/>	<input type="checkbox"/>
20	M20	brace1	12.5										<input type="checkbox"/>	<input type="checkbox"/>
21	M21	brace1	12.5										<input type="checkbox"/>	<input type="checkbox"/>
22	M22	brace1	12.5										<input type="checkbox"/>	<input type="checkbox"/>
23	M23	joist	7.5	15									<input type="checkbox"/>	<input type="checkbox"/>
24	M24	joist	7.5	15									<input type="checkbox"/>	<input type="checkbox"/>
25	M25	joist	7.5	15									<input type="checkbox"/>	<input type="checkbox"/>

These parameters are defined for each cold formed member. The entries are explained below.

Label

You may assign a unique **Label** to all of the members. Each label must be unique, so if you try to enter the same label more than once you will get an error message. You may relabel at any time with the **Relabel** options on the **Tools** menu.

Shape

The member **Shape** or Section Set is reported in the second column. This value is listed for reference only and may not be edited as it is dictated by the entry in the Section/Shape column on the **Primary** tab.

Length

The member **Length** is reported in the third column. This value may not be edited as it is dependent on the member end coordinates listed on the **Primary Data** tab. It is listed here as a reference for unbraced lengths which are discussed in the next section.

Unbraced Length

See the [Unbraced Lengths](#) topic.

K Factors (Effective Length Factors)

See the [Unbraced Lengths](#) topic.

Sway Flags

See the [Unbraced Lengths](#) topic.

C_m - Interactive Bending Coefficient

C_m Coefficients are described in Section C5 of the AISI code. If these entries are left blank, they will be automatically calculated.

The **C_m** value is influenced by the sway condition of the member and is dependent on the member's end moments, which will change from one load combination to the next, so it may be a good idea to leave these entries blank.

C_b - Bending Coefficients

For the cold formed codes, **C_b Coefficients** are used in the calculation of the nominal flexural strength, M_n . If this entry is left blank, it will be calculated automatically.

R Value

The **R Value** for cold formed steel design is described in Section I6.2.1 of the AISI code and is used to calculate the moment capacity of beams that have one flange fastened to deck or sheathing. This value only applies to C or Z members and can vary from 0.4 to 0.7 based on the depth of the member (See Table I6.2.1-1 in the AISI Supplement for the actual values).

If a value is entered by the user, that value will be used by the program in the moment capacity calculation of the member. There are a number of restrictions that must be met to use this section of the code for moment capacity and the user is responsible to check that these restrictions are satisfied.

Note:

- If the R value is entered, the program will use Section I6.2.1 to check moment capacity calculations.

a - Connector Spacing

For double sections, the connector spacing 'a' is used in the calculation of the KL/r . There are also limitations on the connector spacing length that are checked.

Function

The stiffness of gravity members will not be adjusted.

AISI Steel Code Check Results

Access the **Code Check** spreadsheet by selecting the **Results** menu and then selecting **Members** ▶ **Design Results** or by clicking on the **Design Results** button on the Results toolbar.

LC	Mem...	Shape	UC Max	Loc [m]	Shear ...	Loc [m]	Pn [k]	Tn [k]	Mn [k-m]	Cb	Cm	Eqn	
17	6	M17	11C83.75X135	.223	0	.001	0	61.319	89.496	3.737	1	.974	C5.2.1-3
18	6	M18	11C83.75X135	.590	2.5	.080	0	61.319	89.496	3.737	1	.266	C5.2.1-3
19	6	M19	3C81.625X045	.361	2.16	.000	4.507	4.898	10.728	.754	1	1	C5.2.1-1
20	6	M20	3C81.625X045	.171	2.347	.000	4.507	4.898	10.728	.754	1	1	C5.2.1-1
21	6	M21	3C81.625X045	.073	2.3	.000	0	4.898	10.728	.882	1	1	C5.1.1-1
22	6	M22	3C81.625X045	.420	2.347	.000	4.507	4.898	10.728	.754	1	1	C5.2.1-1
23	6	M23	8CU1.25X057	9.999	0	.190	3.25	.439	20.916	2.488	1	.85	C3.3.1-1
24	6	M24	8CU1.25X057	9.999	0	.197	0	.439	20.916	2.543	1	.85	C3.3.1-1
25	6	M25	8CU1.25X057	2.138	1.253	.184	3.167	.439	20.916	.214	1	.85	C5.1.1-2

The final results of the code checking are the code check values **UC Max** and **Shear UC**. These values represent a factored ratio of actual to allowable load for ASD or ultimate load to design strength for LRFD or LSD, based on the provisions of Section H1. Section H2 is also used to check combined bending and shear. So, if this value is less than 1.0, the member passes. If it is greater than 1.0, the member fails. If the value is greater than 9.999 it will be listed as "9.999". The Shear Check is based on section C3.2.1. The Loc field tells at what location the maximum code check occurs measured from the I-joint location of the member. See [Model Display Options - Members](#) to learn how to view the code check results graphically.

The remaining columns, discussed below, provide some of the values used in the code check with the equation number itself given in the last column. The [Member Detail Report](#) gives more values used to perform the code check.

For ASD, the available strengths P_n/Ω , T_n/Ω , M_n/Ω , and V_n/Ω are calculated for the member.

For LRFD or LSD, the values for factored compression $\Phi \cdot P_n$, factored tension $\Phi \cdot T_n$, factored moment $\Phi \cdot M_n$, and factored shear $\Phi \cdot V_n$ are displayed.

P_n is calculated according to the provisions of AISI 2016, Chapter E. T_n is based on Chapter D. The M_n values are calculated based on Chapter F.

C_b will be calculated automatically if not specifically entered by the user, which is conservative. For AISI S100-12, the C_m coefficients described in Section C5 are also listed. These also are influenced by the sway flag settings.

The final field lists the controlling equation for the code check. This will be one of the equations from Section H1 or H2.

For enveloped results, the combination that produced the listed code and shear checks is given in the column "LC". The other values are the corresponding values and are not necessarily the maximums across all the combinations.

The moving load results are enveloped and the governing load combination and step location is shown for each result value under the "LC" column. The first number is the load combination, the second is the step number: (load combination - step number). See [Moving Loads](#) to learn more.

Member Detail Report

The image below is the last portion of a detail report for a Cold Formed Steel member showing the member warnings, code checks, and section properties.

AISI S100-12: ASD Code Check

Combined Shape Design does not consider weak axis 'My' Moments, nor weak axis 'Vz' Forces.

Max Bending Check	0.006	Max Shear Check	0.002 (y)				
Location	5 ft	Location	5 ft				
Equation	C3.3.1-1	Max Defl Ratio	L/10000				
R (D6.1.1) Not Used							
Fy	33 ksi	Cm	.6	Z-Z		A eff. (Fy)	.331 in²
Pn/Ω	6.073 k	Lb	0 ft			A eff. (Fn)	.331 in²
Tn/Ω	7.786 k	KL/r	0			Iy eff.	NC
Mny/Ω	NC					Sy eff. (L)	NC
Mnz/Ω	.519 k-ft	L Comp Flange	0 ft			Sy eff. (R)	NC
Vny/Ω	1.951 k	L-torque	0 ft			Iz eff.	.4 in⁴
Vnz/Ω	NC	Cw	.347 in⁶			Sz eff. (T)	.325 in³
Cb	2.381	a (conn. spacing)	0 ft			Sz eff. (B)	.315 in³

Below describes the Cold Formed Steel specific parameters. Refer to the [Member Detail Report](#) for more information on the values used to perform the code check.

Cw- Torsional warping constant. This will only be shown for Back-to-Back and Face-to-Face shapes. See [Unbraced Lengths](#) topic to understand how the bracing affects this calculation.

a (conn. Spacing)- distance between connections locations of built-up shape. This spacing is checked by code prescribed limits and is used in the calculation of KL/r. This will only be shown for Back-to-Back and Face-to-Face shapes.

A eff. (Fy)- The effective Area used in determining the nominal strength of the section, where the maximum stress is the yield stress.

A eff. (Fn)- The effective Area calculated at stress Fn, where Fn is the nominal buckling stress.

Iy eff. – The effective Moment of Inertia about the y-axis.

Iz eff- The effective Moment of Inertia about the x-axis.

Sy eff(L) - Effective section modulus about the Y axis for the extreme left fiber.

Sy eff.(R) Effective section modulus about the Y axis for the extreme right fiber.

Sz eff(T) - Effective section modulus about the Y axis for the extreme top fiber.

Sz eff.(B) - Effective section modulus about the Y axis for the extreme bottom fiber.

The effective properties listed above are based on the governing values used to determine the Mny and Mnz. The labels on the effective properties will always state "Sy eff" however depending on the governing value it might be the fully unreduced section (Sf), effective section calculated relative to the extreme compression fiber at Fc (Sc) or effective section calculated relative to the extreme compression or tension fiber at Fy (Se).

When the Combined Tensile Axial load and Bending unity equations govern, the Detail Report will display the Sf. When the Combined Bending and Shear unity equations govern, the Detail Report will display the Se. When the Combined Compressive Axial load and Bending unity equations govern, the display depends if governing equations are: local yielding (Se), Lateral Torsional Buckling (Sc) or Distortional Buckling (Sf).

- See [Spreadsheet Operations](#) to learn how to use **Find**, **Sort** and other options.
- See [Model Display Options – Members](#) to learn how to plot member results.

Assumptions and Limitations

For all shape types, it is assumed that the transverse load on the member is occurring through the member's shear center. This means secondary torsional moments that may occur if the load is not applied through the shear center are not considered.

Iterations for the effective section modulus (S_e and S_c) are ended when a difference less than 1% is achieved in the neutral axis distance calculation with a maximum of 5 iterations. Holes in sections are not considered in the shear strength calculations or for effective width calculations. Deflections are based on the full section properties, not the effective section properties.

Torsional warping effects are not included. Torsion stiffness and stress are calculated as pure torsion only. Web crippling is not considered.

See the [Unbraced lengths](#) for Cold Formed Steel section for the full details.

K_t in Section F2.1 is assumed to be 1.0. All conditions listed for the use of C3.1.3-1 are assumed satisfied. Section C3.1.4 is not considered in the calculation of M_n . Effects of shear stiffeners for Section G2 are not considered. Only strong axis bending and strong axis shear are considered for equation C3.3.1 (combined bending and shear).

Section C4.4 is not considered in the calculation of the axial strength at this time.

Z Shapes – The bracing length in **L_{bout}** is assumed to brace the minor principal axis. Z sections in compression are assumed to buckle in Euler buckling about their weakest principal axis. The value of r_{min} is used rather than the geometric r_x and r_y values.

H Shapes – Hat sections in bending about the y-y axis such that the brims are in compression are assumed braced such that the brims cannot each fail in lateral torsional buckling independently. For AISI S100-12 and older, lateral-torsional buckling is not checked for HU shape.

Slenderness Limitations - The w/t limits of Section B4 are enforced. However, the shear lag effects (Section B4.3) are not enforced. Below is an example showing the slenderness checks (AISI S100-12) for a CU and CS shape:

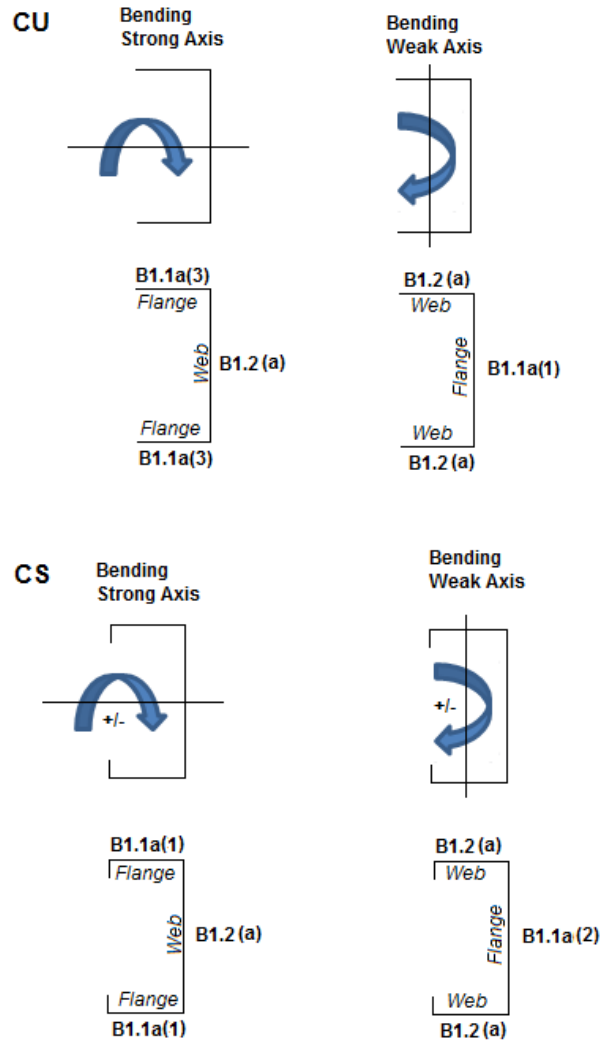

Double Sections

The distance between connector spacing is checked per s_{max} (AISI Eq I1.1-1) however the spacing is considered uniform. The concentrated loads are not checked (AISI Eq I1.1-2) and there is no covered plate sections available (AISI Section I1.3).

The **Slenderness ratio** is altered based on the intermediate fastener spacing when applicable (AISI Eq I1.2-1). The Detail Report will display the modified KL/r if it governs. This modification is applied if the spacing meets the code limits that states a/r_i does not exceed one-half the governing slenderness ratio of the member. The welds length and/or weld/fastener strengths are not checked in RISA (Section I1.2b,c). If the fastener spacing does not satisfy the aforementioned conditions, the global buckling stress of the built-up member is calculated based on the section properties of the individual stud members.

For Back to Back sections, the **Weak Axis** moments (M_y) or shear forces (V_z) for back-to-back shapes are not considered in the code check and this is noted in the Detail Report. The program will give you analysis information in the Detail Report and spreadsheets.

For Face to Face sections, the Torsional Constant (J) and Torsional warping constant (C_w) are calculated based on a tube shape if the Connector spacing is set to fully connected (a=0). If the connector spacing is greater than zero (a>0), the J and C_w calculation will be based on the summation of each element.

Special Messages

AISI Code Check Not Calculated

This message is displayed when the member is not defined with a database shape, or a steel code is not specified on the **Model Settings**, or no units were specified.

Can't do code check, stiffener D/w > 0.7 (Table B4.1-1)

The ratio D/w exceeds the limiting criteria listed in Table B4.1-1 (AISI S100-16) or Section B4.2 (AISI S100-12) for simple lip stiffeners. ("D" and "w" are length of the stiffener and the flat length of the flange as defined in B4.2)

Stiffener angle gamma is < 40 or > 140 (Sect. B4.2)

The angle (gamma) for a simple lip stiffener must be greater or equal to 40 degrees or less than or equal to 140 degrees per the criteria in Commentary Section 1.3 (AISI S100-16) or Section B4.2 (AISI S100-12). The angle gamma for this shape is outside this range.

Can't do code check, flange w/t > limit (Table B4.1-1)

The ratio w/t exceeds the limiting criteria listed in Table B4.1-1 (AISI S100-16) or Section B1.1 (AISI S100-12) for flanges. A value of 60 is used per the AISI code for unstiffened elements and elements stiffened with simple lips.

Can't do code check, web h/t > 200 (Table B4.1-1)

The ratio h/t exceeds the limiting criteria listed in Table B4.1-1 (AISI S100-16) or Section B1.2 (AISI S100-12) for webs. The program currently considers all webs as unreinforced, so a value of 200 is used as the limit.

Can't do code check, Connector spacing 'a' > L/6 per I1.1

The connector spacing "a" exceeds the limiting criteria listed in Section I1.1 (AISI S100-16) or Section D1.1 (AISI S100-12). The "L" in this equation is the beam span (full length of the member).

Concrete Member - Database

There are two types of concrete shapes currently supported, Rectangular and Circular. If you're familiar with the shape definitions, you can type the name directly into the appropriate field. Alternately you may click the  button to have the program generate the desired shape definition for you.

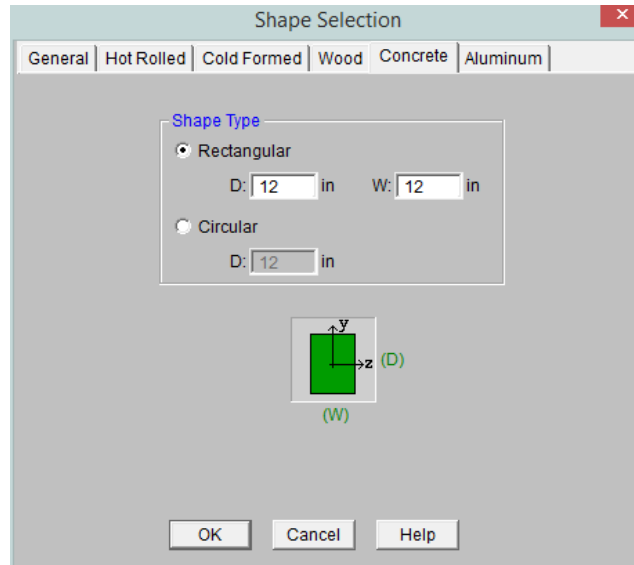

Rectangular Sections

Rectangular sections are defined using a parametric shape code since a rectangular shape may be any depth or width. The code is CRECT'depth'X'width', where 'depth' and 'width' are the values in the current dimension units. For example, if you wanted a beam that was 18" deep and 12" wide, you would enter "CRECT18X12". Note that the dimensions can also be decimal values like "18.25".

Circular Sections

Circular/Round sections are also defined using a parametric shape code since a round shape may have any diameter. The code is CRND'diameter', where 'diameter' is the value in the current dimension units. For example, if you wanted a column that was 14" in diameter, you would enter "CRND14". Note that the dimension can also be a decimal value like "14.5".

Custom Rebar Layout Database

Pressing the  button on the **RISA Toolbar** will open the database that is used for creating and storing custom rebar layouts. This allows the user to create multiple layers of bars and add in compression reinforcement or unusual bar arrangements.

These reinforcement layouts may be assigned to beam or column members in the same way as the other concrete design parameters are assigned. This can be done from the **Concrete** tabs of the **Members Spreadsheet**, the **Design** tab of the **Member Information Dialog**, or the **Modify Members Dialog**.

Label	Start Point	End Point	Shape	Material	Design Rules	Flexural Layout	Shear Layout	Analysis Offset [in]	
1	B1	N7	N8	CRECT20X16	Conc3000NW	Typical	Beam Layout	Shear Layout	0

For additional advice on this topic, please see the RISA Tips & Tricks webpage at risa.com/post/support. Type in Search keywords: **Custom Rebar Layouts**.

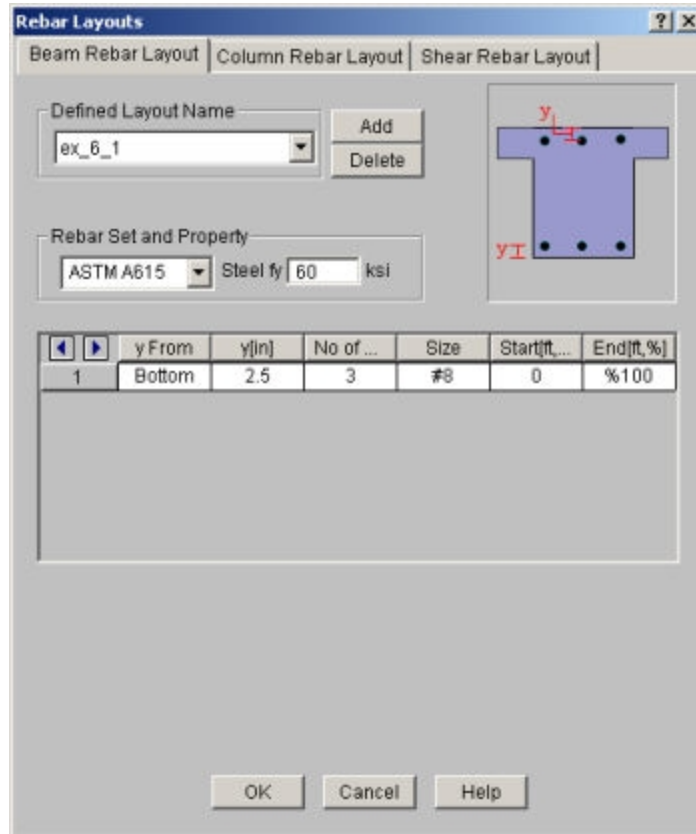

Beam Rebar Layouts

Since beams are only designed for uniaxial bending, the only requirements for the beam layouts are that you specify the depth at which the bars are located and the size & number of the bars that are present at that depth. You can specify the depth with respect to the top surface of the beam or the bottom surface.



The **Start** and **End** locations dictate the location along the length of the beam where these bars will be present. You can use these entries to specify partial length bars that will only be present in locations with a higher moment demand. If the bar should be present for the entire length of the beam, the start location should be '0' and the end location should be '%100' as shown in the dialog above.

Note

- While the rebar layout sheet resembles one of RISA's spreadsheets in appearance it is NOT a spreadsheet and standard TAB controls will not work. Instead, the arrow keys or the new arrow buttons   can be used to advance from cell to cell.

Rectangular Column Rebar Layouts

Since columns are designed for biaxial bending, they require more information about the location and arrangement of the bars.

Normally, column bars are arranged in **layers**. One 'Top' and one 'Bottom' horizontal layer must **always** be defined, each containing at least two bars. These layers, as well as any additional horizontal layers, will be specified by entering a **y1** value to specify the depth from the top or bottom fiber to the centerline of the reinforcing steel. The number and size of the bars must then be entered. The **z1** and **z2** values dictate where

the first and last bar in that layer are located. Additional bars in that layer will be placed so that they are evenly spaced in that layer.

	y1 From	y1[in]	No of...	Size	Start[ft.%]	End[ft.%]
1	Top	1.5	4	#7	0	%100
2	Bottom	1.5	4	#7	0	%100

	Size	z-coord[in]	y-coord[in]	Start[ft.%]	End[ft.%]
1	#8	5	5	0	%100

Vertical layers can be specified by entering a **y1** value specifying the depth from the right or left most fiber to the centerline of the reinforcing steel. The number and size of the bars must then be entered. The **z1** and **z2** values are ignored for vertical layers because the bars will be assumed to be evenly spaced between the required top and bottom layers referred to previously. If this is not desired, then the side bars should be entered individually as **custom single bars**.

Custom single bars are specified by their y and z coordinates measured from the local y and z-axis respectively. A positive y coordinate would place the bar closer to the top fiber and a negative y coordinate would place the bar closer to the bottom fiber. Similarly, a positive z coordinate would place the bar closer to the right side and a negative z coordinate would place the bar closer to the left side.

The **Start** and **End** locations dictate the location along the length of the member where these bars will be present. You can use these entries to specify partial length bars that will only be present in locations with a higher moment demand. If the bar should be present for the entire length of the member, the start location should be '0' and the end location should be '%100' as shown in the dialog above.

Circular Column Rebar Layouts

For circular columns, you may specify equally spaced concentric *rings* of bars at given depths, **z1**, measured from the exterior fiber of the column. You may also specify custom single bars.

Custom single bars are specified by their y and z coordinates measured from the local y and z axis respectively. A positive y coordinate would place the bar closer to the top fiber and a negative y coordinate would place the bar closer to the bottom fiber. Similarly, a positive z coordinate would place the bar closer to the right side and a negative z coordinate would place the bar closer to the left side.

Rebar Layouts [?] [X]

Beam Rebar Layout | Column Rebar Layout | Shear Rebar Layout

Defined Layout Name: [Add] [Delete]

Rectangular Circular

Rebar Set and Property: Steel fy ksi

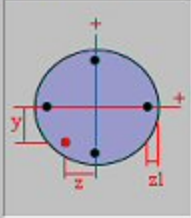

	No of Bars	Size	Start[ft, %]	End[ft, %]	z1[in]
1	4	#7	0	%100	1.5



Custom Single Bars

	Size	z-coord[in]	y-coord[in]	Start[ft, %]	End[ft, %]
1	#8	5	5	0	%100

[OK] [Cancel] [Help]

The **Start** and **End** locations dictate the location along the length of the member where these bars will be present. You can use these entries to specify partial length bars that will only be present in locations with a higher moment demand. If the bar should be present for the entire length of the member, the start location should be '0' and the end location should be '%100' as shown in the dialog above.

Note

- While the rebar layout sheet resembles one of RISA's spreadsheets in appearance it is NOT a spreadsheet and standard TAB controls will not work. Instead, the arrow keys or the new arrow buttons   can be used to advance from cell to cell.

Shear Rebar Layouts

These rebar layouts may be assigned to either columns or beams. They are specified by giving the size and spacing of the bars as well as the location on the member where that reinforcement will be present.

Rebar Layouts

Beam Rebar Layout | Column Rebar Layout | Shear Rebar Layout

Defined Layout Name: Beam Shear Rebar [Add] [Delete]

Legs Per Stirrup: 2



Rebar Set and Property: ASTM A615 Steel fy: 60 ksi

	Size	Spacing[in]	Start[ft,%]	End[ft,%]
1	#4	6	0	%100

OK Cancel Help

The **Start** and **End** locations dictate the location along the length of the member where these bars will be present. You can use these entries to specify partial length reinforcement that will only be present in locations with a higher shear demand. If the reinforcement should be present for the entire length of the member, the start location should be '0' and the end location should be '%100' as shown in the dialog above.

Note

- While the rebar layout sheet resembles one of RISA's spreadsheets in appearance it is NOT a spreadsheet and standard TAB controls will not work. Instead, the arrow keys or the new arrow buttons   can be used to advance from cell to cell.

Concrete Member - Design

Concrete design and optimization can be performed for standard concrete shapes based on the following codes:

- The 2019, 2014, 2011, 2008, 2005, 2002 and 1999 Editions of ACI 318
- The 1997 Edition of the British code (BS 8110)
- The 1992 EuroCode (EC2) and the British publication of the 2014 and 2004 Eurocode (BSEN)
- The 1994 and 2004 Editions of the Canadian code (CSA A23.3)
- The 2000 Edition of the Indian code (IS 456)
- The 2001 Edition of the Australian code (AS 3600)
- The 1995 Edition of the New Zealand code (NZS 3101)
- The 2004 Edition of the Mexican code (NTC-DF)
- The 2007 Edition of the Saudi Building Code (SBC 304)

Note:

- Unless otherwise specified, all code references below are to ACI 318-14.
- Beams and Columns designed in RISA meet all of the requirements for Ordinary Moment Frames except for the additional requirements indicated in ACI 318-14 Section 18.3. Those provisions should be checked by hand outside of RISA.

The program will design the longitudinal and shear reinforcement for rectangular beams and rectangular or circular columns. These calculations encompass all the code requirements except those noted in the [Limitations](#) section of this document. The program also provides reinforcement detailing information for concrete beams and interaction diagrams for concrete columns in the member detail reports.

To Apply a Concrete Design Code

1. On the **Code** tab of **Model Settings Dialog**, select the concrete code from the drop down list.
2. Click **Apply** or **OK**.

Concrete Spans

RISA-2D will automatically break a concrete physical member into spans based on the number of internal supports. Each internal joint is NOT automatically treated as a support. Instead, we go through the whole model geometry to determine where a beam or column is supported. Note that for a physical member to see a support, there must be a joint at that support point. If a physical column and a physical beam cross each other without a joint at their intersection, then no support / span will be detected and they will not be connected.

Beam member types are supported by the following: Vertical Boundary Conditions (Fixed, Reaction), Column Members, Near Vertical Plate Elements, and other Beam Members that are supporting that member.

Column member types are supported by the following: Horizontal Boundary Conditions (Fixed, Reaction, Spring), Beam Members, Near Horizontal Plate Elements, and Rigid Diaphragms.

Note

- The quickest way to create new joints at beam / column intersections is to run a Model Merge.
- Clear spans must be greater than 1 ft for the program to design the member. This considers half the depth of the columns or beams framing into the ends of the member.
- The program's ability to recognize spans is important because it will give you more relevant span to span information without overwhelming you with independent design results for each finite element segment that comprises your physical member.

- For continuous beam members, the program will evaluate the framing to determine which beams elements are supporting other beam elements so that only supporting members are treated as supports and not vice versa.
- Currently, members of type HBrace, VBrace, and None do not affect the span distances. Nor do any arbitrary joints within each span along a member.

Concrete Design Parameters - Columns

The Concrete Column tab on the **Members Spreadsheet** records the design parameters for the code checks of concrete columns. These parameters may also be assigned graphically. See [Modifying Member Design Parameters](#) to learn how to do this.

	Label	Shape	Length(ft)	Lu-out(ft)	Lu-in(ft)	Cm-out	Cm-in	K-out	K-in	Out sway	In sway	Icr Factor
1	M7	Conc-Col	10							<input type="checkbox"/>	<input type="checkbox"/>	
2	M8	Conc-Col	10							<input type="checkbox"/>	<input type="checkbox"/>	
3	M9	Conc-Col	10							<input type="checkbox"/>	<input type="checkbox"/>	

The following parameters can be defined for each concrete column.

Label

You may assign a unique **Label** to all of the members. Each label must be unique, so if you try to enter the same label more than once you will get an error message. You may relabel at any time with the **Relabel** options on the **Tools** menu.

Shape

The member **Shape** or Section Set is reported in the second column. This value is listed for reference only and may not be edited as it is dictated by the entry in the Section/Shape column on the **Primary** tab.

Length

The member **Length** is reported in the third column. This value may not be edited as it is dependent on the member end coordinates listed on the **Primary Data** tab. It is listed here as a reference for unbraced lengths which are discussed in the next section.

Unbraced Length

You may specify unbraced lengths or have RISA-2D calculate them for you. The unbraced lengths are **Lu-out** and **Lu-in**.

The **Lu** values, **Lu-out** and **Lu-in**, represent the unbraced length of column members with respect to column type buckling out of plane and in plane, respectively. These **Lu** values are used to check the column for Euler buckling, and for the [Moment Magnification Procedure](#) in older editions of the ACI code.

If left blank these unbraced lengths all default to the member's full length.

For [physical members](#), you can enter the code "**Segment**" in the unbraced length fields and the length of each segment will be used. A "segment" is the distance between the joints that are on the physical member. For example, suppose you have a physical member that is 20 feet in length, and there are two joints along the physical member, one 5 feet from the end and one at 15 feet. An unbraced length of 5 feet will be used for the first segment, then a value of 10 feet will be used in the middle segment, and again a value of 5 feet would be used in the last segment.

Note

- When the "segment" code is used, ALL joints on a column will be considered to brace the column for that type of buckling, even if a joint is associated with a member that would actually only brace the column against buckling in the other local axis. Therefore, the "segment" code should only be used for columns that are truly braced in that direction at each interior joint.
- The calculated unbraced lengths are listed on the **Member Detail** report.

For additional advice on this topic, please see the RISA Tips & Tricks website: www.risa.com/post/support. Type in Search keywords: **Unbraced Lengths**.

K Factors (Effective Length Factors)

The **K Factors** are also referred to as effective length factors. **K-out** is for column type buckling out of plane and **K-in** is for buckling in plane.

If a value is entered for a **K Factor**, that value will be used for the entire length of the physical member. If an entry is not made (left blank), the value will internally default to '1' for that member. See ACI 318-14 Section R6.2.5 (ACI 318-11 Section R10.10.1) for an explanation of how to calculate K Factors.

RISA-2D is able to approximate the K-values for a column based on the member's sway condition and end release configuration. The K-factor approximation is based on the idealized tables given in the AISC steel specification. The following table gives the values used for various conditions.

Table Case	End Conditions	Sidesway?	K-Value
(a)	Fixed-Fixed	No	.65
(b)	Fixed-Pinned	No	.80
(c)	Fixed-Fixed	Yes	1.2
(d)	Pinned-Pinned	No	1.0
(e)	Fixed-Free	Yes	2.1
(f)	Pinned-Fixed	Yes	2.0

Note

- This is an approximation of K-values and is NOT based on the Jackson and Moreland Alignment Charts presented in ACI 318-14 Section R6.2.5.

RISA-2D will recognize a pinned boundary condition for the K approximation for a full pin, i.e. if all the rotations in the boundary condition are released. If any of the rotations in a boundary condition are restrained, the boundary condition is considered "fixed" for the K approximation.

Any configuration not described here will be given the default value of 1.0.

If any value that influences these K values is changed, the K approximation should be redone. For instance, if you have RISA-2D approximate K-values then change some end release designations, you should redo the K approximations.

Remember that the K-values are *approximations*, and you should check to make sure you agree with all K-values RISA-2D assigns. You can always override a K-value after an approximation by directly entering the value that you want in the appropriate field. Keep in mind that a subsequent approximation will overwrite any manually input values so you will need to override the approximation each time it is performed.

Limitation:

RISA-2D will currently neglect the influence of adjoining framing members when those members are connected at a joint that also has degrees of freedom restrained by boundary conditions. For example, suppose a column and beam member connect at a joint that is restrained for translation in both directions (i.e. the joint is "pinned"). The K factor approximation will neglect the beam member when it calculates the K factor for the

column and vice versa. The effect will be that the ends of the members at that joint will be seen as “pinned” and not “fixed” for the K-factor approximation.

Sway Flags

The **Sway Flags** indicate whether the member is to be considered subject to sidesway for bending in and out of plane. The **Out sway** field is for out of plane bending and the **In sway** field is for in plane bending. Click on the field to check the box and indicate that the member is subject to sway for that particular direction, or leave the entry blank if the member is braced against sway. These sway flags influence the calculation of the K Factors as well as the C_m .

C_m – Equivalent Moment Correction Factor

The **C_m Coefficients** are used to check the column for Euler buckling, and for the [Moment Magnification Procedure](#) in older editions of the ACI code. **C_m -out** is for bending out of plane and **C_m -in** is for bending in plane. If these entries are left blank they will be automatically calculated.

In the ACI design code, the C_m values are only applicable for non-sway frames. Therefore, this value will be ignored if the corresponding sway flag is checked.

Flexural and Shear Rebar Layout

The user may choose to manually create the reinforcement layout for the column. This must be done if the user wishes to take advantage of bundled bars, multiple layers of reinforcement, or an unequal number of bars per face. See the section on the Concrete Database and [Rebar Layouts](#) for more information. If 'Default' is specified, then the program will design for an equal number of bars in each face of the rectangular column and may vary that reinforcing based on ACI minimums, maximums and the moment and shear demand at each section along the span.

I_{cr} Factors (Cracked Moment of Inertia Factors)

The **I_{cr} Factor** is used to reduce the bending stiffness of concrete columns per ACI 318-14 Table 6.6.3.1.1(a) (ACI 318-11 Section 10.10.4.1). If this entry is left blank, default values of 0.35 for beams and 0.70 for columns will be used.

Note

- The **I_{cr} Factor** will be ignored if the “**Use Cracked Sections**” box is not checked on the **Concrete** tab of the **Model Settings** dialog.
- The alternative calculations in ACI 318-14 Table 6.6.3.1.1(b) (ACI 318-11 Equations 10-8 and 10-9) are not considered.
- The sustained load reduction of ACI 318-14 Section 6.6.3.1.1 (ACI 318-11 Section 10.10.4.2) is not considered.

Service Level Stiffness

Due to cracking and material non-linearity, modeling the stiffness of concrete members is more complex than it is for steel or wood members.

For typical applications, ACI 318-14 Section 6.6.3.1 (ACI 318-11 Section 10.10.4) requires that member stiffness be reduced to account for the cracking that occurs when a member is subjected to ultimate level loads. As described in the previous section, RISA uses the **I_{cr} Factor** to account for this stiffness reduction. However, for service level analysis, the level of cracking will be significantly less. Therefore, the stiffness used in your analysis should be representative of the reduced loading and reduced cracking. Per the ACI 318-14 Section R6.6.3.2.2 (ACI 318-11 Section R10.10.4.1), the program will account for this increased stiffness by applying a factor of 1.43 to the cracked section properties for any load combination that has the “**Service Load**” flag checked on the **Design** tab of the **Load Combinations Spreadsheet**.

Note**Concrete Design Parameters - Beams**

The **Concrete Beam** tab on the **Members Spreadsheet** records the design parameters for the code checks of concrete beams. These parameters may also be assigned graphically. See [Modifying Member Design Parameters](#) to learn how to do this.

	Label	Shape	Length(ft)	B-eff Left(in)	B-eff Right...	Slab T...	Slab T...	Icr Fact...	Flexural Layout	Shear Layout
1	M1	CRECT12X12	12.0416						Use Design Rule	Use Design Rule
2	M2	CRECT12X12	13.4536						Use Design Rule	Use Design Rule
3	M3	CRECT12X12	8.9443						Use Design Rule	Use Design Rule
4	M4	CRECT12X12	18.0278						Use Design Rule	Use Design Rule

The following parameters can be defined for each concrete member.

Label

You may assign a unique **Label** to all of the members. Each label must be unique, so if you try to enter the same label more than once you will get an error message. You may relabel at any time with the **Relabel** options on the **Tools** menu.

Shape

The member **Shape** or Section Set is reported in the second column. This value is listed for reference only and may not be edited as it is dictated by the entry in the Section/Shape column on the **Primary** tab.

Length

The member **Length** is reported in the third column. This value may not be edited as it is dependent on the member end coordinates listed on the **Primary Data** tab. It is listed here as a reference only.

Flexural and Shear Rebar Layout

The user may choose to manually create the reinforcement layout for the beam. This must be done if the user wishes to take advantage of compression steel, or multiple layers of reinforcement. See [Concrete Database - Rebar Layouts](#) for more information. If *Use Design Rule* is specified, then the program will design for one layer of reinforcing and may vary that reinforcing based on ACI minimums, maximums, and the moment and shear demand at each section along the span using the Member Design Rules as the parameters of the reinforcement selection. If you define your own rebar layout, and compression reinforcement is defined, then the program will consider the compression reinforcement in the analysis.

Icr Factors (Cracked Moment of Inertia Factors)

The **Icr Factor** is used to reduce the bending stiffness of concrete beams.

For ACI and Canadian codes (ACI 318-14 Section 6.6.3.1 and A23.3-04 section 9.2.1.2), if this entry is left blank, the Icr factor will default to a value of 0.35 for beams and 0.70 for columns.

For Australian and New Zealand codes (per section 6.6.2 of AS3600-2001), this will default to a value of 0.4 for beams and 0.8 for columns.

For Indian and Saudi codes, this entry will default to a value of 1.0 for beams and columns.

Note

- The **Icr Factor** will be ignored if the “**Use Cracked Stiffness**” box is not checked on the **Concrete** tab of the **Model Settings** dialog.

Service Level Stiffness

Due to cracking and material non-linearity, modeling the stiffness of concrete members is more complex than it is for steel or wood members.

For typical applications, ACI 318-14 Section 6.6.3.1 (ACI 318-11 Section 10.10.4) requires that member stiffness be reduced to account for the cracking that occurs when a member is subjected to ultimate level loads. As described in the previous section, RISA uses the **Icr Factor** to account for this stiffness reduction. However, for service level analysis, the level of cracking will be significantly less. Therefore, the stiffness used in your analysis should be representative of the reduced loading and reduced cracking. Per ACI 318-14 Section R6.6.3.1.1 (ACI 318-11 Section R10.10.4.1), the program will account for this increased stiffness by applying a factor of 1.43 to the cracked section properties for any load combination that has the “**Service Load**” flag checked on the **Design** tab of the **Load Combinations Spreadsheet**.

Note

T-beam & L-beam Sections

T-beams and **L-beams** may be specified by assigning effective slab widths and slab thicknesses for the left and right side of the beam on the **Concrete Beam** tab of the **Members Spreadsheet**. These modifications may also be made graphically via the **Modify Properties** tab of the **Draw Members** tool.

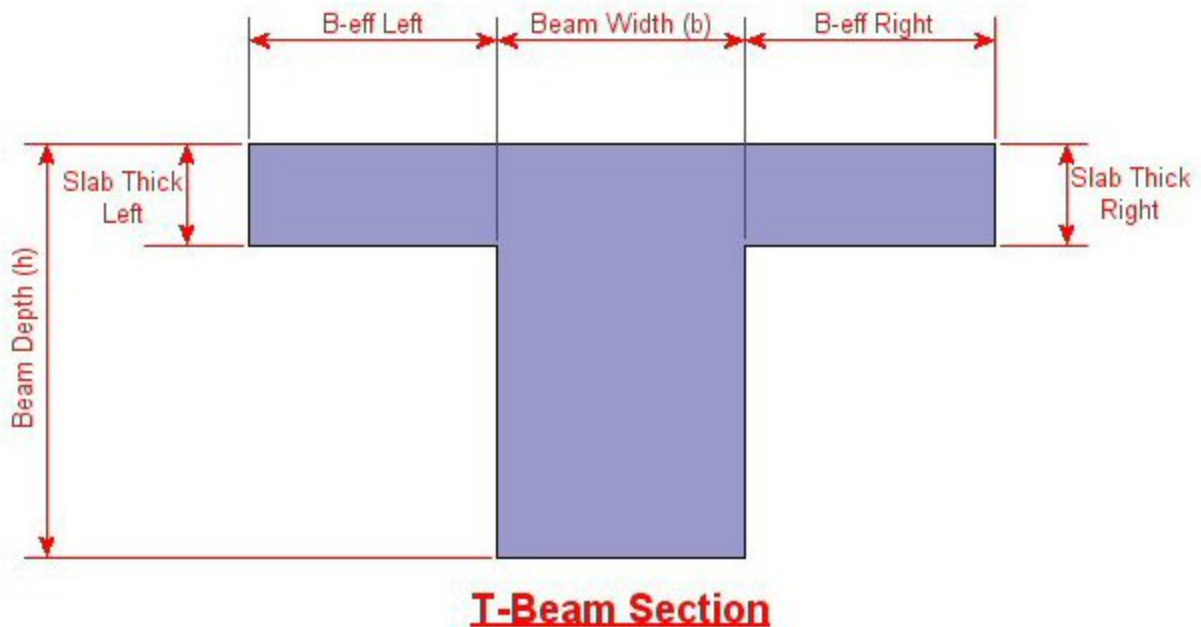

RISA-2D will automatically trim the effective slab widths, **B-eff Left** and **B-eff Right**, to the maximum values indicated in ACI 318-14 Table 6.3.2.1 (ACI 318-11 Sections 8.12.2(a) and 8.12.3(a) & (b)) if the value entered by the user is greater than that allowed by the code. It should be noted that RISA-2D does not check ACI 318-14 Table 6.3.2.1 portions referring to adjacent framing (ACI 318-11 Sections 8.12.2(b) and 8.12.3(c)) because no adjacent framing checks are performed.

If the values of either **B-eff Left** or **B-eff Right** are left blank, a value of zero will be assumed, indicating no additional slab width beyond 1/2 the beam width on that side.

Note:

- B-eff Right corresponds to the positive local z-axis of the beam. Subsequently, B-eff Left corresponds to the negative local z-axis.

Parabolic vs. Rectangular Stress Blocks

You can specify whether you want your concrete design to be performed with a rectangular stress block, or with a more accurate parabolic stress block. While most hand calculations are performed using a rectangular stress block, the parabolic stress block is more accurate. In fact, most of the PCA design aids are based upon the parabolic stress distribution. A good reference on the parabolic stress block is the PCA Notes on ACI 318-99.

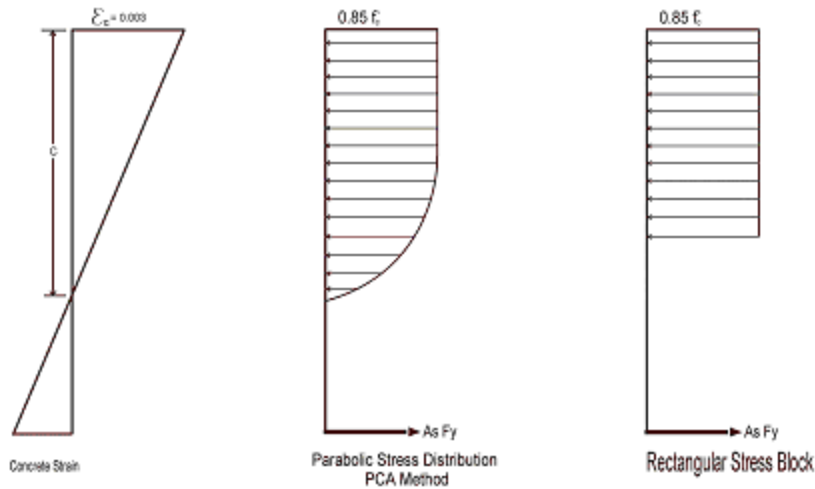
**Biaxial Bending of Columns**

You can specify whether you want your column design to be performed by using **Exact Integration**, or by using the **PCA Load Contour Method**. While most hand calculations are performed using the Load Contour Method, this method is merely an approximation based on the uniaxial failure conditions and the Parme Beta factor. In contrast, the Exact Integration method uses the true biaxial strain state to design the member. A good reference on the Load Contour Method is chapter 12 of the PCA Notes on ACI 318-99.

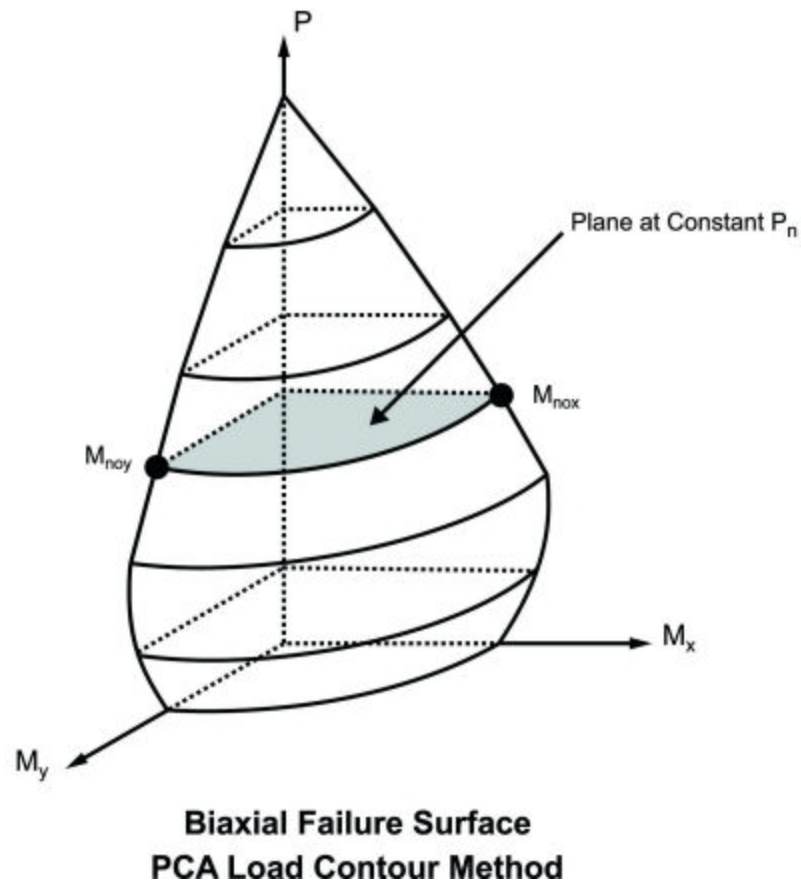

British Eurocode Design Parameters (BS EN 1992-1-1: 2004)

General

- f_{ck} – Can not be more than 50 MPa (7252 psi) for normal strength concrete
- α_{cc} is assumed to be 1 (recommended value) : See 3.1.6
- Effective length of T and L: $L_o = 0.7 \cdot \text{span length}$ and $b_{eff,i} = L_o / 10$
- $\varphi_{concrete} = 1.5$
- $\varphi_{rebar} = 1.15$
- Maximum bar spacing for beams = 300 mm

Tension Development Length

- $\alpha_{ct} = 1$ (assumed in Eq 3.16)
- $\eta_1 = \eta_2 = 1$ (assumed in Eq 8.2 to calculate bond stress)
- $\lambda_3, \lambda_5, \lambda_4 = 1$ (assumed in Eq 8.4)
- C_d in Table 8.2 assumed to be 1 bar diameter rebar spacing
- Development length when hooks are provided uses same assumptions as BS 8110-1: 1997

Shear Capacity of Concrete

To compute the shear capacity of concrete the following recommended values are being used:

- $C_{Rd,c} = 0.18/\gamma_c$ for Eq 6.2.a
- $v_{min} = 0.035 k^{3/2} f_{ck}^{1/2}$
- $v = .6*[1 - f_{ck}/250]$
- V_{max} is calculated from Eq. 6.5.
- θ is assumed 45 degrees in Eq 6.8.

Slender Column Design

- Biaxial column design done using Eq. 5.39
- Design based on nominal curvature
- $\lambda_{lim} = 20 A B C/n^{1/2}$ (A=.7, B= 1.1, C=0.7 for unbraced)
- $K_\phi = 1$ in Eq 5.34; the effect of creep is neglected.

Limitations - General

Torsion – Beams and columns ignore torsion with respect to the design of shear reinforcement. A message is shown in the detail report to remind you of this. You can turn the warning messages off on the **Concrete** tab of the **Model Settings Dialog**.

Creep / Long Term Deflections – No considerations are taken in the analysis to account for the effects of creep or long term deflections.

Beam Design – Beams are not designed for weak axis y-y bending, weak axis shear, or axial forces. A message is shown in the detail report to remind you of this. You can turn the warning messages off on the **Concrete** tab of the **Model Settings Dialog**. Beams currently do not consider any compression steel in the calculation of the moment capacity. Beam "skin reinforcement" per the requirements of ACI 318-14 Section 9.7.2.3 (ACI 318-11 Section) 10.6.7 for beams with "d" greater than 36" is currently not specified by the program. The provisions in ACI 318-14 Section 9.9 (ACI 318-11 Section 10.7) for deep beams are not considered.

Column Design – Columns with biaxial moment and no axial load will currently be designed using the **PCA Load Contour Method** even if Exact Integration is selected on the Model Settings dialog. This is shown on the detail report.

Limitations - ACI

Shear Design –When ACI 318-19 is selected, the shear strength of concrete (V_c) uses equations in Table 22.5.5.1. Note that for members meeting the minimum shear reinforcement requirement ($A_v \geq A_{v,min}$), V_c is taken as the larger of the results calculated by the equations (a) and (b) in the table. ACI 318-19 code suggests ρ_w may be taken as the sum of the areas of longitudinal bars located more than two-thirds of the overall member depth away from the extreme compression fiber. Therefore, RISA calculates ρ_w as the sum of the areas of longitudinal bars on the tension face.

When other ACI 318 editions are selected, the shear strength of the concrete alone is limited to the standard $2*\lambda*\sqrt{f'c}$ equation from ACI 318-14 Section 22.5.5.1 (ACI 318-11 Section 11.2.1.1) and does not use the more detailed calculations of ACI 318-14 Table 22.5.5.1 (ACI 318-11 Section 11.2.2). Also, note that for members with significant axial tension (greater than 0) the program designs the shear reinforcement to carry the total shear per ACI 318-14 Section R22.5.7.1 (ACI 318-11 Section 11.2.1.3).

Deep Beam Design – The program does not design deep beams as defined in ACI 318-14 Section 9.9.1.1(a) (ACI 318-11 Section 10.7).

Limitations - Canadian Code

Concrete Stress Profile – Concrete stress strain curve (parabolic) is assumed same as PCA method for the Canadian codes.

Bi-Axial Bending - The program uses the simplified uniaxial solution provided in the Canadian specification rather than performing a complete biaxial condition.

Mid-Depth Flexural Strain for Shear Design - The program uses the code equation (per the General Method) to calculate ε_x with the moment and shear at the section taken from the envelope diagrams. The maximum ε_x for each span is conservatively assumed for the entire span. Currently the program has no option for pre-stressing, so V_p and A_p are both taken as zero.

Shear Design - The shear strength of concrete is calculated using β and θ , which are both calculated per the General Method (Clause 11.3.6.4 from the 2004 CSA A23.3). S_{ze} is calculated per equation 11-10 and a_g is always assumed to equal 20 mm (maximum aggregate size).

Limitations - Australian and New Zealand Codes

Concrete Stress Profile – Concrete stress strain curve (parabolic) is assumed same as ACI for the New Zealand and Australian codes.

Neutral Axis Parameter – K_u in AS code is always assumed to be less than 0.4.

Rebar Spacing – NZS and AS codes: max spacing of rebar (beam) is 300 mm and minimum spacing is one bar diameter or 25mm whichever is bigger.

Shear Strength in Beams – In AS code, when calculating the shear strength of a beam β_2 , β_3 are always assumed to be unity. This is always conservative for beams with little axial load, or beams in compression. But, may be unconservative for members subjected to significant net tension.

Bi-Axial Bending – The New Zealand code does not appear to give a simplified method for solving biaxial column design. Therefore, the PCA load contour method is being used instead.

Shear Tie Spacing – Column/beam shear tie spacing is based on (a) and (c) of NZS 9.3.5.4 :1995.

Development Length – Development length in NZS is based on NZS 7.3.7.2 where α_a is conservative assumed to be 1.3 (top bars) for all cases. For the AS code, it is assumed that $K_1=1$ and $K_2=2.4$ in clause 13.1.2.1 of AS 3600:2001.

Slender Column Calculations – EI is assumed to be equal to $0.25EcI_g$ (with $\beta d = 0.6$) in slender column calculations in AS and NZS codes (like in ACI).

Limitations - British

Concrete Stress Profile – Concrete stress strain curve (parabolic) is taken from the British specification.

Cracked Sections – $I_{cracked}$ defaults to 1.0 for the British code. But, a user entered value may be entered if desired. Service level stiffness is assumed to be 1.43 times the strength stiffness, but is not allowed to exceed I_{gross} .

Bi-Axial Bending – The program uses the simplified uniaxial solution provided in the British specification rather than performing a complete biaxial condition.

Limitations - Euro

Concrete Stress Profile – Concrete stress strain curve (parabolic) is taken from the EuroCode specification.

Cracked Sections – $I_{cracked}$ defaults to 1.0 for EuroCode. But, a user entered value may be entered if desired. Service level stiffness is assumed to be 1.43 times the strength stiffness, but is not allowed to exceed I_{gross} .

Bi-Axial Bending – The program uses the simplified uniaxial solution provided in the EuroCode rather than performing a complete biaxial condition.

Limitations - Indian

Concrete Stress Profile – Concrete stress strain curve (parabolic) is taken from the Indian specification.

Cracked Sections – Cracked defaults to 1.0 for the Indian code. But, a user entered value may be entered if desired. Service level stiffness is assumed to be 1.43 times the strength stiffness, but is not allowed to exceed I_{gross} .

Bi-Axial Bending – The program uses the simplified uniaxial solution provided in the Indian specification rather than performing a complete biaxial condition.

Limitations - Saudi Code

Concrete Stress Profile – Concrete stress strain curve (parabolic) is assumed to be the same as the ACI code.

Shear Strength– The shear strength is based on 11.3.1.1 and does not include the more detailed provisions of section 11.3.1.2.

Yield Strength of Shear Ties - The yield strength of shear ties is not allowed to exceed 420MPa.

Shear Tie Spacing - Minimum spacing of shear ties is set to 50mm

Bi-Axial Bending – Both the Exact Integration and the PCA Load Contour methods for bi-axial bending are supported in the Saudi code.

Special Messages

In some instances code checks are not performed for a particular member. A message is usually shown in the **Warning Log** and **Detail Report** explaining why the code check was not done. There are also instances where a code check is performed, but the results may be suspect as a provision of the design code was violated. In these cases, results are provided so that they can be examined to find the cause of the problem. Following are the messages that may be seen.

No Load Combinations for Concrete Design have been run.

None of the load combinations that were run had the **Concrete Design** box checked on the **Design** tab of the **Load Combinations Spreadsheet**. Since there are no concrete design specific load combinations, there are no results or force diagrams to show.

Warning: No design for spans with less than 5 sections.

Certain very short spans in physical members can end up with less than 5 design sections. No design is attempted without at least 5 sections because maximum values may be missed and an un-conservative design may result.

Warning: No design for spans less than 1 ft.

Certain very short spans in physical members can end up with lengths less than 1 foot. No design is attempted for these sections.

Warning: Member is slender and can sway, but P-Delta Analysis was NOT run.

Under older ACI codes slender sway members need to be run with the P-Delta option turned on to account for secondary forces and moments. In some situations, a preliminary design without P-Delta is useful and so a design is performed and this warning is shown to remind you to run the final analysis including P-Delta effects.

Alternately, if you're using the redesign feature, the next suggested column may resolve this issue if it's not slender.

Warning: Slender Compression Failure ($P_u > .75P_c$). No Slender calculations done.

Since RISA-2D allows you to specify a starting column size, it's possible that for slender columns under substantial axial load you'll exceed the critical buckling load used in the slenderness equations in ACI 318-14 Section 6.6.4.5.2 (ACI 318-11 Section 10.10.6). Design results are still shown so the suggested shapes can be used to pick a new suggested column size that will not have this problem. Note that the design results shown are NOT valued because the slender moment effects have NOT been considered.

Warning: $KL/r > 100$ for this compression member. See ACI 318-05 Section 10.11.5

Members that violate the KL/r limit still have design results calculated and shown. If you're using the redesign feature, the next suggested shape should resolve this problem. Note this is only checked for the 2005 code and older. Newer codes require a P-Delta analysis and omit this consideration.

Warning: Exact Integration selected but PCA method used

This message is shown when you've requested the **Exact Integration** option on the **Model Settings Dialog**, but we weren't able to converge a solution for the column in question. When Exact Integration does not converge, the **PCA Method** is used instead to give an idea of the demand vs. the capacity.

Warning: PCA Method Failed. Axial Load > Axial Capacity.

One of the limitations of the **PCA Method** is that it requires the column being checked to have a greater axial capacity than the axial demand. Since RISA-2D allows you to set a starting size, it's possible that the demand may be greater than the capacity. In this case a very rough estimate of the capacity is calculated by using the independent moment capacity about each axis considering the axial load. The resulting code check value is then based on the combined demand vector over the combined capacity vector and will always be greater than 1.0. The purpose of the results in this case is to show the column failed, not to give an accurate estimate of the over-demand. The redesign feature will suggest a larger shape to resolve this issue.

Warning: The shear tie spacing does not meet the code Minimum Requirement

This warning is stating that either minimum spacing or strength requirements are not being met for the shear reinforcement in the concrete member.

P-Delta analysis required for all ACI 318-14/11/08 Load Combinations

A second order analysis is required as of the 2014, 2011 and 2008 editions of the ACI 318 code. A code check will only be given if [P-Delta](#) is turned on in the [Load Combinations](#) spreadsheet, or if this requirement is intentionally waived in the [Application Settings](#).

Concrete Member - Design Results

You can access the **Concrete Results Spreadsheets** by selecting the **Results Menu** and then selecting **Members** ▶ **Design Results** and **Concrete Reinforcing**. Unlike wood and steel, concrete results are different for beams and columns so they each get their own results spreadsheet. Note also that concrete results are always based on envelope results, even if you've run a batch solution.

For beam flexural design, the required bars are based on the envelope moment diagrams. For column flexural design, the required bars for each load combination are calculated at various sections for the moments and axial forces at those sections. The required bars for all load combinations are then enveloped. For both beam and column shear steel design, the required bars are based on the enveloped shear force diagrams.

Beam Results

Beam results are shown in the three following spreadsheets: **Design Results**, **Beam Bending Reinforcement**, and **Beam Shear Reinforcement**.

Design Results Spreadsheet

The **Design Results Spreadsheet** shows the governing maximum code check for the top and bottom of the beam for all spans.

Member	Shape	UC Max Top	Loc[ft]	UC LC	UC Max Bot	Loc[ft]	UC LC	Shear UC	Loc[ft]	UC LC	Phi*Mnz T...	Phi*Mnz B...	Phi*Vny[k]
M8	CRECT30X12	.613	.781	3	.665	7.5	3	.468	3.125	3	75.204	75.204	31.52
M9	CRECT30X12	.613	14.219	3	.665	7.5	3	.468	11.875	3	75.204	75.204	31.52
M10	CRECT30X12	.128	.781	3	.138	7.5	3	.471	3.125	3	361.004	361.004	31.307
M11	CRECT24X8	.238	.781	3	.605	12.5	3	.477	3.906	3	112.291	59.43	16.46
M12	CRECT24X8	.238	.781	3	.605	12.5	3	.477	3.906	3	112.291	59.43	16.46
M13	CRECT24X8	0	0	N/A	.826	12.5	3	.458	17.188	3	0	150.668	16.317
M14	CRECT24X8	0	0	N/A	.891	12.5	3	.466	16.927	3	0	150.668	16.317

These top and bottom code checks, **UC Max Top** and **UC Max Bot**, are based on the top/bottom moment capacities and maximum top/bottom moment. Currently the moment capacity is based only on the tension steel (NO compression steel is considered in the capacity calculation). The governing maximum shear check for all spans, **Shear UC**, is also shown. The capacities shown are only for the governing section. Capacities for each span, as well as beam reinforcement detailing diagrams, may be viewed on the [Detail Report](#).

Beam Bending Reinforcement Spreadsheet

The **Beam Bending Reinforcement Spreadsheet** records the top and bottom flexural reinforcement steel required for the left, middle, and right locations of each beam. This spreadsheet may be accessed by selecting **Members** ▶ **Concrete Reinforcing** on the **Results Menu** and the results are listed on the **Beam Bending** tab.

Member	Shape	Span	Left Top	Left Bot	Mid Top	Mid Bot	Right Top	Right Bot
M21	CRECT12X8	1	2 #5			2 #5	2 #5	
M22	CRECT12X8	1	2 #5			2 #5	2 #5	
M23	CRECT12X8	1	2 #5			2 #5	2 #5	
M24	CRECT12X8	1	2 #5			2 #5	2 #5	

The **Member** column lists the beam label.

The **Shape** column displays the beam size. When no adequate member could be found from the available shapes list, this field will display the text "not designed". Consider re-framing, relaxing the design requirements (see [Design Optimization](#)), or adding more shapes to the available Redesign List (see [Appendix A – Redesign Lists](#)).

The **Span** column displays the span number corresponding to the reinforcement sections listed. Span '1' is the span beginning at the "start" of the beam and subsequent spans are numbered '2', '3', '4', and so forth moving from the "start" to the "end" of the beam.

The program assumes that the moment diagrams for all beam spans have two or fewer points of inflection. Therefore, each span is broken into **Left, Middle, and Right Reinforcement Sections** for flexural steel layout. Each section is further broken into **Top and Bottom Reinforcement Sections**. Note that a beam may have only two or even one reinforcement section. In this case, the other reinforcement sections would be left blank in this spreadsheet.

The **Left Top, Left Bot, Mid Top, Mid Bot, Right Top,** and **Right Bot** entries record the number and size of flexural reinforcement bars that are required in each of the six **Reinforcement Sections**. The first number indicates the number of parallel reinforcement bars in that section. The second number, preceded by the '#' sign, indicates the size of reinforcement bars used.

Note

- Only reinforcement bars selected by the program are listed in this spreadsheet. If a custom rebar layout is used for a particular beam, all six reinforcement section entries will report "CUSTOM" as a reminder that the user applied a custom rebar layout.
- Longitudinal reinforcement bars are assumed to be in a **single layer** at the top and/or bottom of the member.
- Longitudinal reinforcement bars for the left and right sides of adjacent spans have been "smoothed" such that the larger steel area is used for both sides.

Beam Shear Reinforcement Spreadsheet

The **Beam Shear Reinforcement Spreadsheet** records the shear reinforcement ties required in each shear region of each beam. This spreadsheet may be accessed by selecting **Members** ▶ **Concrete Reinforcing** on the **Results Menu** and the results are listed on the **Beam Shear** tab.

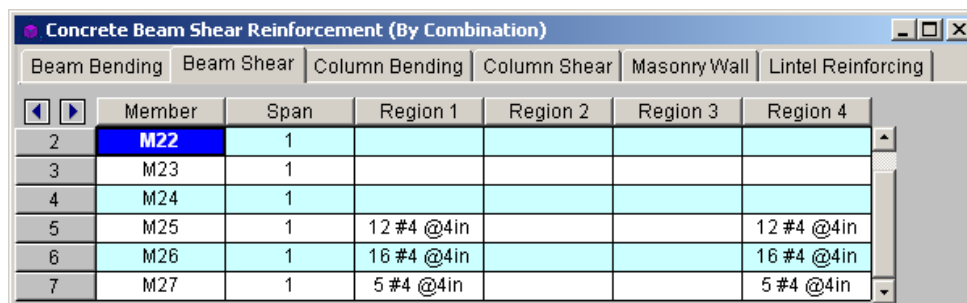

	Member	Span	Region 1	Region 2	Region 3	Region 4
2	M22	1				
3	M23	1				
4	M24	1				
5	M25	1	12 #4 @4in			12 #4 @4in
6	M26	1	16 #4 @4in			16 #4 @4in
7	M27	1	5 #4 @4in			5 #4 @4in

The **Member** column lists the beam label.

The **Span** column displays the span number corresponding to the shear regions listed. Span '1' is the span beginning at the "start" of the beam and subsequent spans are numbered '2', '3', '4', and so forth moving from the "start" to the "end" of the beam.

Each beam's shear reinforcement layout is broken into either two or four **Shear Reinforcement Regions**. The user can control whether the program uses '2' or '4' regions from the **Concrete** tab of the **Model Settings Dialog**. The program will try to group the required shear ties/stirrups into two or four regions and will allow for a middle region to have no shear reinforcement if the shear force is lower than that for which the code requires shear reinforcement.

The **Region 1**, **Region 2**, **Region 3**, and **Region 4** entries record the number, size, and spacing of shear reinforcement ties/stirrups that are required in each of the **Reinforcement Regions**. The first number of each entry indicates the total number of ties/stirrups that are required in that region of the beam span. The second number, preceded by the '#' sign, indicates the size of reinforcement bars used. The third number, preceded by the '@' symbol, indicates the spacing of the ties/stirrups in that region of the beam span.

Note

- If '2' shear regions are selected on the **Concrete** tab of the **Model Settings Dialog**, the Region 2 and Region 3 entries in this spreadsheet will be left blank.
- The concrete code checks are only performed at the sections where the internal forces are calculated. The number of internal force calculations is based on the setting in the [Model Settings](#) dialog. Normally, this is acceptable for design and analysis. However, it is possible for the design locations (face of support for moment and "d" from the face of support for shear) to be located far enough away from the nearest internal force location that it could affect the code check results. If this happens, it may be advisable to use a larger number of internal sections. Or, the user may be forced to calculate the maximum V_u and M_u themselves.

Column Results

Column results are shown in the three following spreadsheets: **Design Results**, **Column Bending Reinforcement**, and **Column Shear Reinforcement**.

Design Results Spreadsheet

The **Design Results Spreadsheet** shows the governing maximum code check for the column for all spans.

Column	Shape	UC Max	Loc	UC LC	Shear UC	Loc	Dir	Phi used	Pn[k]	Mn[k-ft]	Vn[k]	
1	M7	Crect1 2x12	.785	9.479	11	.113	0	y	.862	11.816	42.487	31.551
2	M8	Crect1 2x12	.943	.521	11	.135	.521	y	.864	10.971	42.224	31.551
3	M9	Crect1 2x12	9.999+	.521	10	.151	10	y	.9		24.93	30.931

The governing maximum shear check for all spans is also shown. The governing load combination for the governing code check is shown because the column capacity is based upon the actual moments and axial forces for that load combination. The capacities shown are only for the governing section. Capacities for each span, as well as column reinforcement detailing diagrams, may be viewed on the [Detail Report](#).

The moving load results are enveloped and the governing load combination and step location is shown for each result value under the "UC LC" column. The first number is the load combination, the second is the step number: (load combination - step number). See [Moving Loads](#) to learn more.

Column Bending Reinforcement Spreadsheet

The **Column Bending Reinforcement Spreadsheet** shows the perimeter flexural reinforcement steel required in each span of each column. This spreadsheet may be accessed by selecting **Members** ▶ **Concrete Reinforcing** on the **Results Menu** and the results are listed on the **Column Bending** tab.

Column	Shape	Span	Perim Bars	
1	M5	crect1 2x12	1	4 #6
2	M6	crect1 2x12	1	4 #6
3	M7	crect1 2x12	1	4 #6
4	M8	crect1 2x12	1	4 #6

The **Column** field displays the column label.

The **Shape** column displays the physical column or lift size. When no adequate member could be found from the available shapes, this field will display the text "not designed". Consider re-framing, relaxing the design or deflection requirements (see [Design Optimization](#)), or adding more shapes to the available Redesign List (see [Appendix A – Redesign Lists](#)).

The **Span** column displays the span number corresponding to the perimeter reinforcement listed. Span '1' is the span beginning at the "start" of the column and subsequent spans are numbered '2', '3', '4', and so forth moving from the "start" to the "end" of the column.

The **Perim Bars** column records the number and size of perimeter longitudinal reinforcing bars. The first number indicates the total number of longitudinal bars in that span. The second number, preceded by the '#' sign, indicates the size of the reinforcement bars used.

Note

- Only reinforcement bars selected by the program are listed in this spreadsheet. If a custom rebar layout is used for a particular column, the **Perim Bars** entry will be left blank.
- Longitudinal reinforcement bars are assumed to be uniformly arranged around the perimeter of the column for both rectangular and round column sections.
- A minimum of 6 bars will be used in round column sections.
- Longitudinal reinforcement bars for the bottom and top sides of adjacent spans have been "smoothed" such that the larger steel area is used for both sides.

Column Shear Reinforcement Spreadsheet

The **Column Shear Reinforcement Spreadsheet** shows the shear reinforcement ties required in each shear region of each column. This spreadsheet may be accessed by selecting **Members** ▶ **Concrete Reinforcing** on the **Results Menu** and the results are listed on the **Column Shear** tab.

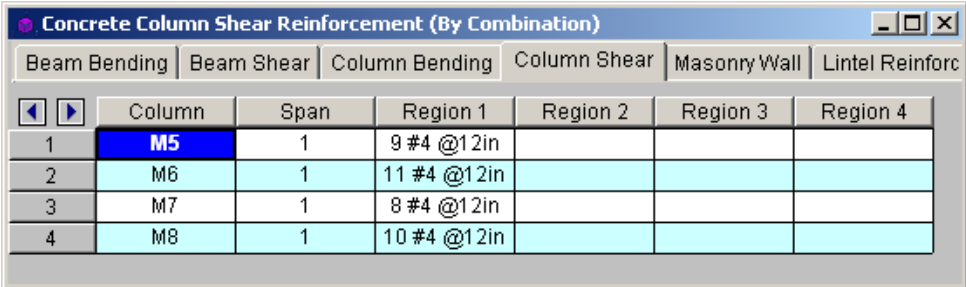

Concrete Column Shear Reinforcement (By Combination)						
	Beam Bending	Beam Shear	Column Bending	Column Shear	Masonry Wall	Lintel Reinforc
	Column	Span	Region 1	Region 2	Region 3	Region 4
1	M5	1	9 #4 @12in			
2	M6	1	11 #4 @12in			
3	M7	1	8 #4 @12in			
4	M8	1	10 #4 @12in			

The **Column** field displays the column label.

The **Span** column displays the span number corresponding to the shear regions listed. Span '1' is the span beginning at the "start" of the column and subsequent spans are numbered '2', '3', '4', and so forth moving from the "start" to the "end" of the column.

Each column's shear reinforcement layout is broken into either two or four **Shear Reinforcement Regions**. The user can control whether the program uses '2' or '4' regions from the **Concrete** tab of the **Model Settings** dialog. The program will try to group the required shear ties into 2 or 4 regions. Unlike beams, columns cannot have a zero shear steel region. Note also that columns in tension receive NO shear capacity from the concrete.

The **Region 1**, **Region 2**, **Region 3**, and **Region 4** entries record the number, size, and spacing of shear reinforcement ties/stirrups that are required in each of the **Reinforcement Regions**. The first number of each entry indicates the total number of ties/stirrups that are required in that region of the column span. The second number, preceded by the '#' sign, indicates the size of reinforcement bars used. The third number, preceded by the '@' symbol, indicates the spacing of the ties/stirrups in that region of the column span.

Note

- If '2' shear regions are selected on the Concrete tab of the Model Settings dialog, the Region 2 and Region 3 entries in this spreadsheet will be left blank.

Concrete Detail Reports

The **Concrete Detail Reports** allow you to see the overall force, stress, and deflection state for any particular member. Detail reports for concrete members are not based on individual load combinations as they are for steel or wood members. Instead, they are based on an envelope of the solved load combinations. Concrete columns are the exception to this in that the columns are solved for all load combinations and then the resulting required steel is enveloped. The detail reports for concrete Column member types are also different than those for concrete Beam member types in terms of the design information that is shown below the force diagrams.

Detail reports for concrete members can, and often do, go more than one page in length due to the large amount of information that must be displayed for concrete design. One reason for this is that RISA-2D figures out the number of spans for concrete beams and columns based on the number of internal supports, thus one physical member may have several spans that all must be reported.

Note:

-  - This button will allow you to take a snapshot of the current detail report you are viewing so that it can be added to a report. View the [Printing](#) topic for more information.

Beam Detail Reports

The image below is the first portion of a detail report for a concrete beam member showing the member information, warnings, force diagrams, code checks, and span information.

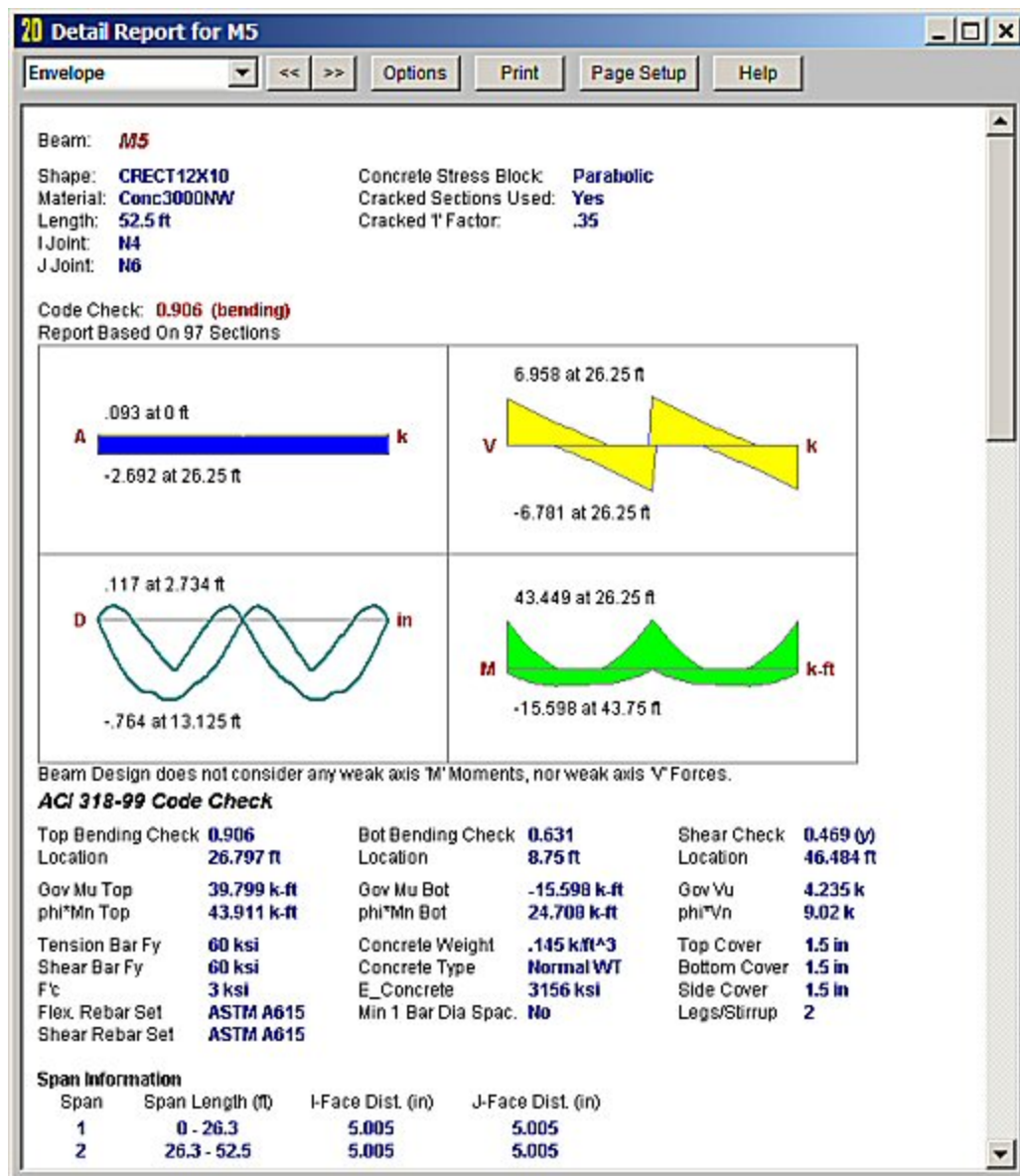

You can tell the **Member Type** by looking at the black title in the upper left corner next to the red member label. This title will always show the member type (Beam, Column, HBrace, VBrace). If the member type is 'None', this title will be displayed as 'Member'.

The **Member Information** in the text above the force diagrams shows basic member information as well as the **Concrete Stress Block** type used in the solution, whether **Cracked Sections** were used for the nominal design, and the **Cracked 'I' Factor** that was used for that member.

The next section of the detail report contains the **Member Force Diagrams**. The diagrams shown are envelope diagrams of all solved load combinations. Any **Unused Force Warnings** or critical **Design Warnings** will be shown directly below the force diagrams in the detail report.

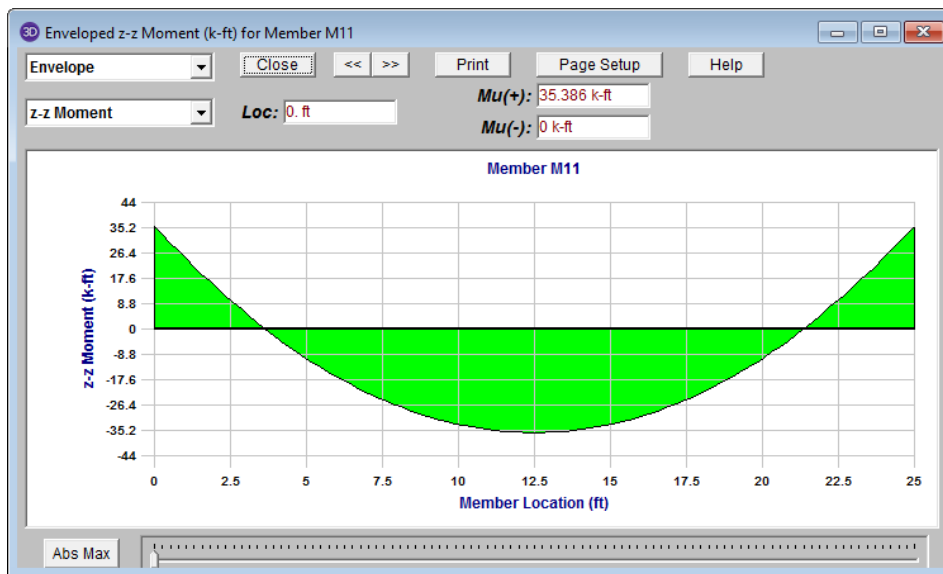

Each enlarged diagram will also have a slider bar at the bottom of the window for checking forces at all locations along the member. There is also an **Abs Max** button that will jump the slider bar to the absolute maximum value in the diagram. Note that once an enlarged diagram is opened, diagrams for other forces may be accessed via the pull down menu on the left.

The **Code Check Information** directly below the force diagrams is a summary of the governing checks for bending and shear, their location, and the section capacities at those locations. Separate bending checks for the most critical top and most critical bottom condition are given. **Gov Muz Top** and **Gov Muz Bot** represent the governing ultimate moment in the top and bottom of the beam respectively. **Gov Vuy** represents the governing ultimate shear along the local y axis of the beam.

The values **phi*Mnz Top** and **phi*Mnz Bot** represent the nominal moment strength in the top and bottom of the beam respectively, reduced by the appropriate **Strength Reduction Factor, Phi**, as indicated in the code. Likewise, the value **phi*Vuy** represents the nominal shear strength in the beam, reduced by the appropriate Phi Factor.

There is also general concrete, reinforcement, and bar cover information about the section provided which you would need if you were doing a hand check. **Concrete Type** (Normal Weight vs Light Weight) is automatically determined from the **Concrete Weight** density per the ACI code. λ is taken from the [Materials](#) spreadsheet. The **E_Concrete** value shown here is either the value entered on the **Concrete** tab of the **Materials Spreadsheet** or is the calculated value based on the given f'_c and weight density (if the 'E' value was left blank on the Materials Spreadsheet).

The **Span Information** gives the start and end of each span centerline within the member, as well as the distance from the column centerline to the face of the column for each end of the span.

The next portion of the detail report shown below contains detailed information for the placement of the **Bending Steel** and the **Bending Span Results** for each span. The bending capacity for the governing section in each span is shown as **Mnz**, the nominal moment strength. **Rho Min** and **Rho Max** are the minimum and maximum required reinforcement ratios at each location. These values are based on the minimum and maximum reinforcing requirements for flexural members as described in ACI 318-14 Sections 9.6.1 and 21.2.2/9.3.3.1 respectively (ACI 318-11 Sections 10.5.1 and 10.3.3/10.3.5 respectively). **Rho** is the ratio of reinforcement corresponding to the area of steel provided at each location, **As Prvd**. The **As Req** value is the area of steel required at each location.

Note:

- Per ACI 318-14 Section 9.6.1 (ACI 318-11 Section 10.5.3), the reinforcement ratio (ρ) chosen by the program can be less than ρ_{\min} when A_s Provided exceeds A_s Required by more than 33%

Bending Steel			
Span	Loc	Top/Bot	Bars Provided
1	Left	T	2 #7
	Left	B	2 #5
	Mid	T	-
	Mid	B	2 #5
	Right	T	2 #7
	Right	B	2 #5
2	Left	T	2 #7
	Left	B	2 #5
	Mid	T	-
	Mid	B	2 #5
	Right	T	2 #7
	Right	B	2 #5

Bending Span Results								
Span	Loc (ft)	Top/Bot	Mn (k-ft)	Rho Min	Rho Max	Rho	As Prvd (in ²)	As Reqd (in ²)
1	.5	T	48.79	.0033	.016	.0126	1.203	1.013
	.5	B	27.453	.0033	.016	.0063	.614	.121
	-	T	0	0	0	0	0	0
	8.8	B	27.453	.0033	.016	.0063	.614	.386
	25.7	T	48.79	.0033	.016	.0126	1.203	1.061
	25.7	B	27.453	.0033	.016	.0063	.614	.051
2	26.8	T	48.79	.0033	.016	.0126	1.203	1.061
	26.8	B	27.453	.0033	.016	.0063	.614	.051
	-	T	0	0	0	0	0	0
	43.2	B	27.453	.0033	.016	.0063	.614	.374
	52	T	48.79	.0033	.016	.0126	1.203	1.013
	52	B	27.453	.0033	.016	.0063	.614	.121

Shear Steel		
Span	Region (ft)	Bars Provided
1	1.1 - 5.5	15 #4 @4in
	-	-
2	20.2 - 25.2	17 #4 @4in
	27.3 - 32.3	17 #4 @4in
	-	-
	47 - 51.4	15 #4 @4in

Shear Span Results						
Span	Region (ft)	Vn (k)	Vc (k)	Vs (k)	As Reqd (in ²)	As Prvd (in ²)
1	1.1 - 5.5	52.376	10.475	41.901	0	.098
	-	0	0	0	0	0
	20.2 - 25.2	52.376	10.475	41.901	0	.098
2	27.3 - 32.3	52.376	10.475	41.901	0	.098
	-	0	0	0	0	0
	47 - 51.4	52.376	10.475	41.901	0	.098

The next portion of the detail report, shown above, contains detailed information for the placement of the **Shear Steel** and the **Shear Span Results** for each span. Shear results are shown by region within each span. The number of regions used is a function of the shear diagram, with the maximum number of regions being taken from the **Shear Regions** setting on the **Concrete** tab of the **Model Settings Dialog**. The number, size, and spacing of reinforcing bars is given for each region. Also indicated is the nominal shear strength, **Vn**, in each region. The portion of the nominal shear strength provided by the concrete and the steel, **Vc** and **Vs** respectively, is given for each region. The area of steel required, **As Reqd**, and the area of steel provided, **As Prvd**, are also given for each shear region and are reported as 'area of steel per unit dimension', i.e. in²/in or mm²/mm.

It should be noted that the values for **Mn** and **Vn** given in this section of the detail report are the UNREDUCED nominal capacities of the member at each span/region. The actual design capacities would be obtained by multiplying these values by their respective **Phi Factors** indicated in the code.

The last section of the detail report shows the **Beam Reinforcement Detailing Diagrams**. The **Rebar Detailing** portion of the report shows elevation views of the beam complete with top and bottom flexural reinforcement indicated for the left, middle, and right portions of each span. The number and size of bars required in each section is indicated on the top middle of each drawn bar. The required length of each bar is indicated on the bottom middle of each drawn bar in parenthesis. Development lengths are shown in parenthesis at one end of each bar and is represented by a dashed line. For bars at the ends of the beam, hook lengths are given in addition to the development lengths and are shown in brackets.

Note:

- Development lengths are calculated per ACI 318-14 Sections 25.4.2 and 25.4.3 (ACI 318-11 Sections 12.2.2 and 12.5.2. No additional factors are used, aside from the lightweight modification factor.

The values shown at the bottom corner of each span indicate the distance from the start of the beam to the face of a support. Flexural bars at the ends of the beam are measured beginning at the face of the support and bars at intermediate supports are measured to the center of the support.

The number, size, and spacing of shear reinforcement is also indicated below each span in the corresponding shear region. Each shear region is indicated by vertical lines at the bottom of the beam.

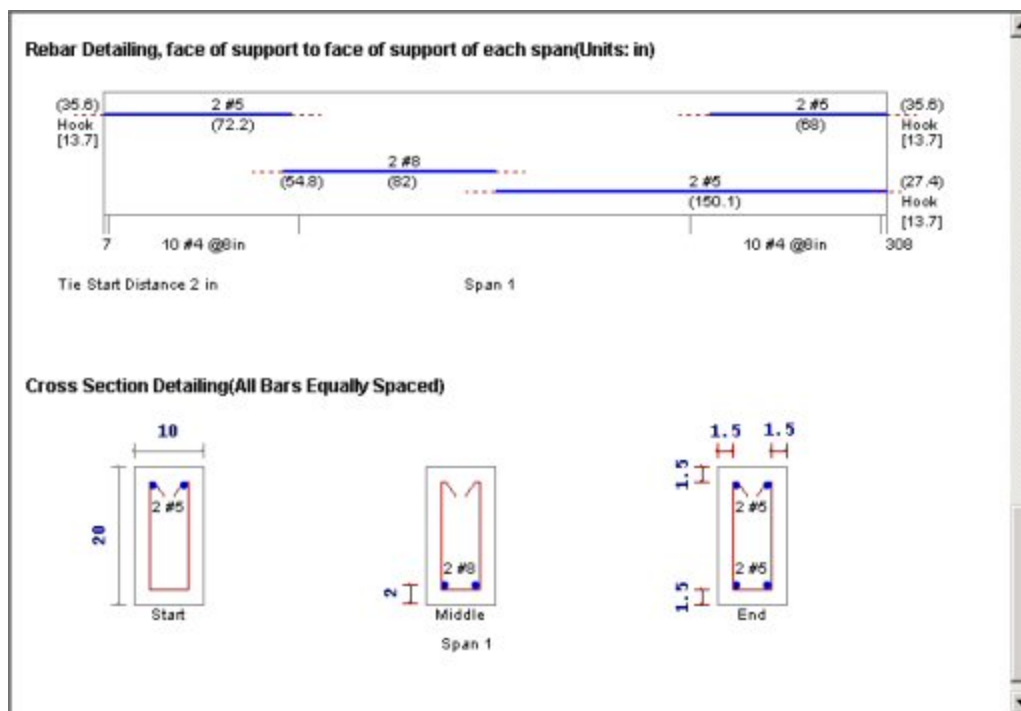

The **Cross Section Detailing** portion of the report shows cross sectional views for the start, middle, and end of each beam span. The number and size of flexural bars for each cross section are shown as well as the orientation of the shear ties/stirrups. The clear cover to each stirrup for the top and sides is shown. The overall beam dimensions for each span are indicated on the 'Start' cross section.

Column Detail Reports

The image below is the first portion of a detail report for a concrete column member showing the member information, warnings, force diagrams, code checks, and span information. As can be seen, the concrete column results are very similar to the beam results with just a few additions and differences.

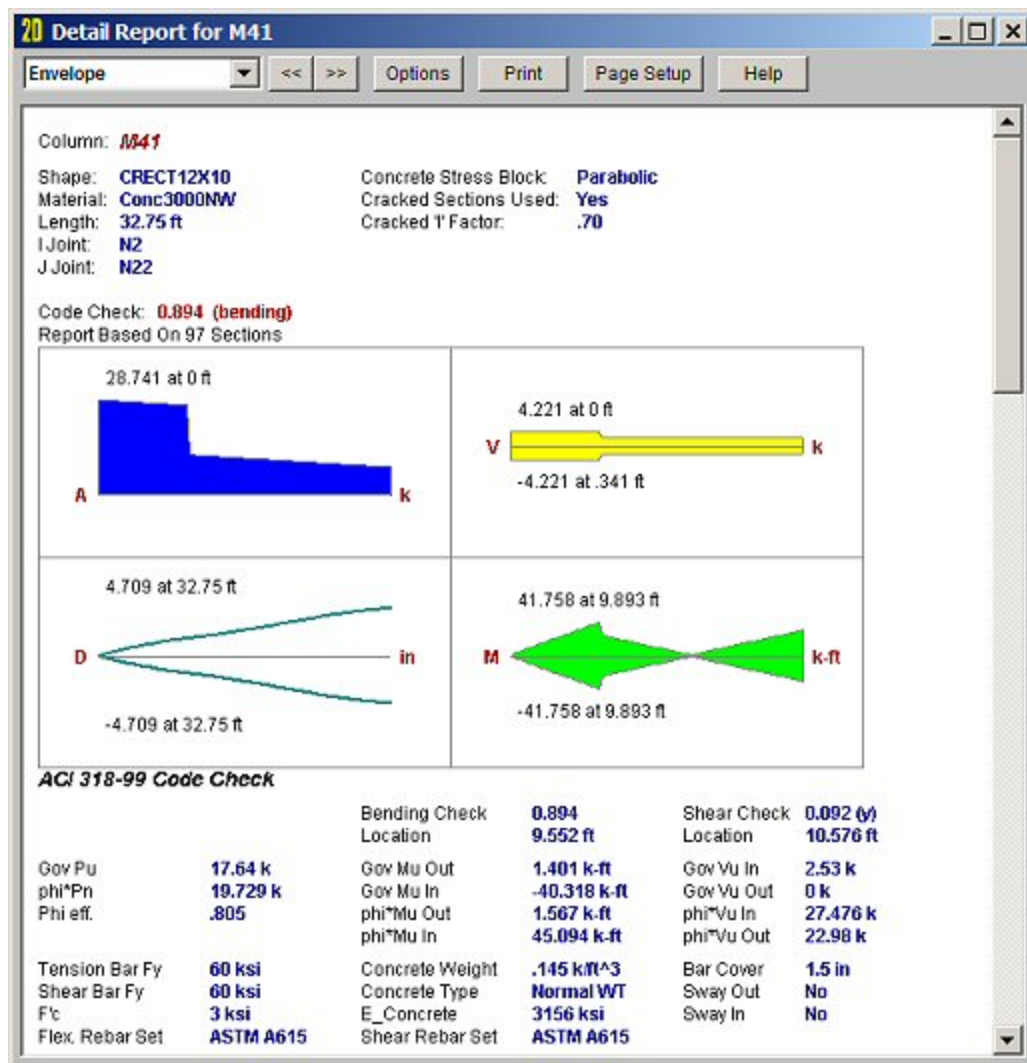

You can tell the **Member Type** by looking at the black title in the upper left corner next to the red member label. This title will always show the member type (Beam, Column, HBrace, VBrace). If the member type is "None", this title will be displayed as "Member".

The **Member Information** in the text above the force diagrams shows basic member information as well as the **Concrete Stress Block** type used in the solution, whether **Cracked Sections** were used for the nominal design, and the **Cracked 'I' Factor** that was used for that member.

The next section of the detail report contains the **Member Force Diagrams**. The diagrams shown are envelope diagrams of all solved load combinations. Any **Unused Force Warnings** or critical **Design Warnings** will be shown directly below the force diagrams in the detail report. An enlarged interactive member force diagram can be accessed by clicking on the desired diagram. For more information, see [Beam Detail Reports](#).

The **Code Check Information** below the force diagrams is a summary of the governing checks for bending and shear, their location, and the section capacities at those locations. **Gov Pu** represents the governing ultimate axial load in the column. **Gov Mu In** and **Mu Out** represent the governing ultimate moment in and out of plane. **Gov Vu In** and **Vu Out** represent the governing ultimate shear in and out of plane.

There is also general concrete, reinforcement, and bar cover information about the section provided which are useful for hand calculation verification. **Concrete Type** (Normal Weight vs Light Weight) is automatically determined from the **Concrete Weight** density per the ACI code. The **E_Concrete** value shown here is either the value entered on the **Concrete** tab of the **Materials Spreadsheet** or is the calculated value based on the given f'_c and weight density (if the 'E' value was left blank on the Materials Spreadsheet).

Note:

- When solving using the PCA Load Contour method, P_u will always equal P_n . This represents the axial value at which the controlling slice of interaction diagram was taken. The bending check is taken as the following equation, which is derived from the PCA Notes on ACI 318-99, Chapter 12.

$$UC = \left(\frac{M_{uy}}{\phi M_{noy}} \right)^{\frac{\log 0.5}{\log \beta}} + \left(\frac{M_{uz}}{\phi M_{noz}} \right)^{\frac{\log 0.5}{\log \beta}}$$

- When solving using the Exact Integration method, a worst-case combination of P_u , M_{uy} , and M_{uz} is determined. A straight line is essentially drawn between the origin of the interaction diagram, and this coordinate within the 3D interaction diagram. The bending check is taken as the length of that line, divided by the distance from the origin to the intersection of that line and the interaction diagram. For this reason the ratios $(P_u/\phi P_n)$, $(M_u/\phi M_n)$ are all equal to the bending check.

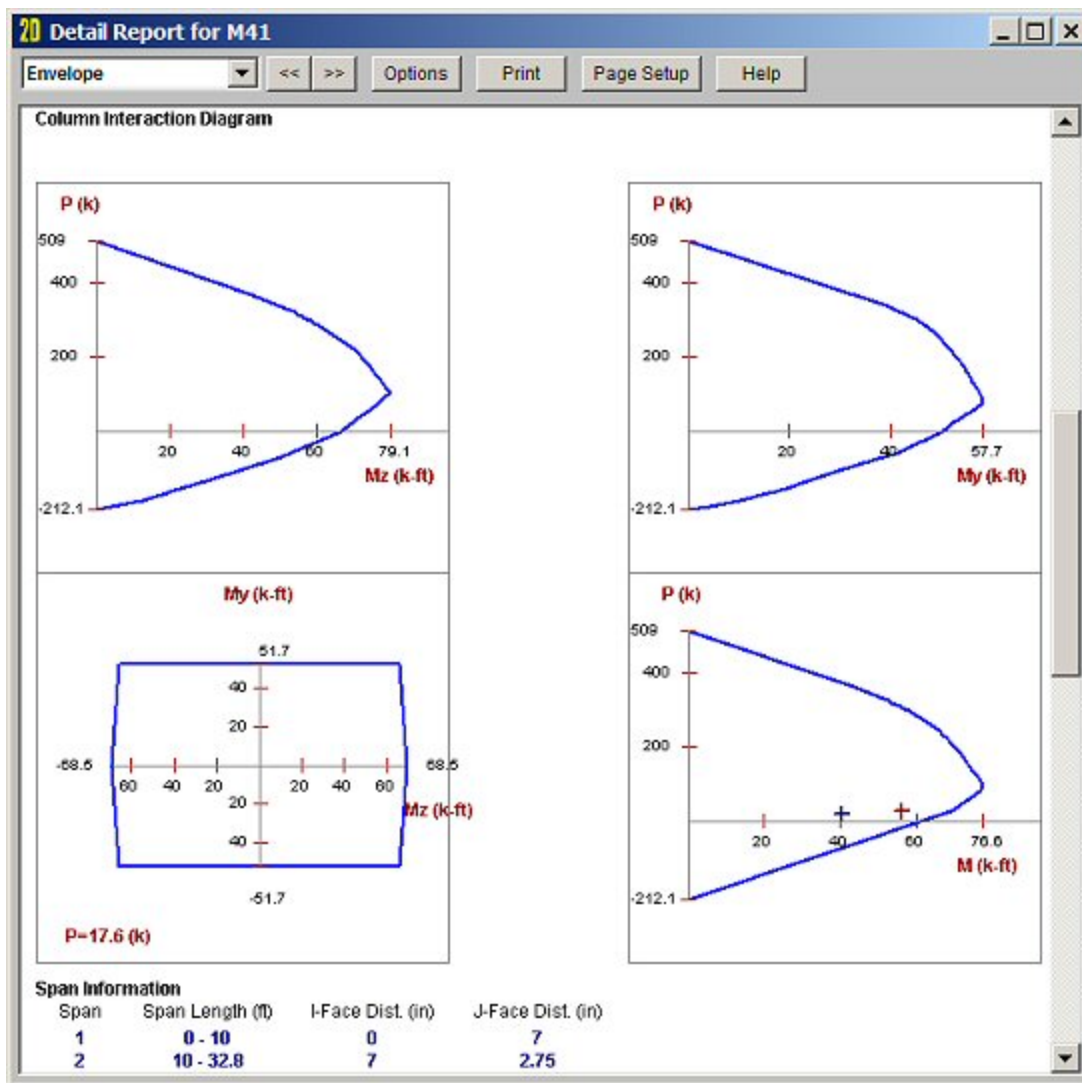

The next portions of the detail report shown above contain the **Column Interaction Diagrams** for the column member and the **Span Information**.

A **Column Interaction Diagram** for uniaxial bending is shown for each axis of the column. These diagrams plot the unreduced nominal strengths **P vs. M** for the corresponding column local axis. If the column only has bending about one axis there will be only one interaction diagram shown.

For columns under biaxial bending there is also a diagram which plots the unreduced nominal moments strengths **Mz vs. My** at the governing ultimate axial load, **P**. The last diagram is for the biaxial bending condition where the exact integration method is used and shows the interaction surface plotted at the angle of applied load (P_u, M_{uy}, M_{uz}). This last diagram is only shown when the **Exact Integration Method** is used.

The **Span Information** section shows the length of each span and the distances from the centerline of each support to the face of each support.

20 Detail Report for M41

Envelope << >> Options Print Page Setup Help

Column Steel						
Span	Main Bars	Gov LC	Loc (ft)	Pu (k)	Mu Out (k-ft)	Mu In (k-ft)
1	8 #6	11	9.552 ft	20.542	1.632	39.543
2	4 #10	10	10.576 ft	8.837	.663	30.363

Axial Span Results					
Span	Phi_eff	Pn (k)	Po (k)	Rho Gross	As Prvd (in^2)
1	.76	36.333	509.045	.0295	3.534
2	.75	28.774	597.103	.0422	5.067

Bending Span Results								
Span	ecc. In (ft)	ecc. Out (ft)	NA Out (ft)	NA In (ft)	Mn Out (k-ft)	Mn In (k-ft)	Mno In (k-ft)	Mno Out (k-ft)
1	1.925	.079	-.124	.505	2.886	69.939		
2	3.436	.075	-.111	.485	2.158	98.859		

Slender Bending Span Results								
Span	KL/r Out	KL/r In	Cm Out	Cm In	Lu Out (ft)	Lu In (ft)	Mc Out (k-ft)	Mc In (k-ft)
1	42	28	.6	-.1	10	10	1.632	
2	95	63	.6	.4	22.75	22.75	.663	30.363

Shear Steel		
Span	Region (ft)	Bars Provided
1	0 - 9.6	12 #4 @10in
	-	-
	-	-
2	10.6 - 32.4	27 #4 @10in
	-	-
	-	-

In Plane Shear Span Results						
Span	Region (ft)	Vn In (k)	Vc In (k)	Vs In (k)	As In Reqd (in^2)	As Prvd (in^2)
1	0 - 9.6	33.222	10.544	22.678	0	.039
	-	0	0	0	0	0
	-	0	0	0	0	0
	-	0	0	0	0	0
2	10.6 - 32.4	32.325	10.259	22.066	0	.039
	-	0	0	0	0	0
	-	0	0	0	0	0
	-	0	0	0	0	0

Out Plane Shear Span Results						
Span	Region (ft)	Vn Out (k)	Vc Out (k)	Vs Out (k)	As Out Reqd (in^2)	As Prvd (in^2)
1	0 - 9.6	27.989	10.023	17.966	0	.039
	-	0	0	0	0	0
	-	0	0	0	0	0
	-	0	0	0	0	0
2	10.6 - 32.4	27.035	9.682	17.353	0	.039
	-	0	0	0	0	0
	-	0	0	0	0	0
	-	0	0	0	0	0

This portion of the report shown above contains the sections pertaining to the axial, bending, and shear results as well as the longitudinal and shear reinforcement.

The **Column Steel** section indicates the longitudinal reinforcement in each span as well as the governing load combination and location. The ultimate axial load, **Pu**, and the ultimate moments, **Mu out** and **Mu in**, are also given for each span.

The **Axial Span Results** show the strength reduction factor, **Phi_eff**, used for each span. The axial capacities for each span are shown as **Pn**, the nominal axial strength, and **Po**, the nominal axial strength with zero eccentricity. The area of longitudinal reinforcement provided in the column is listed as **As Prvd** and the ratio of **As Prvd** to the gross cross sectional area of the column is listed as **Rho Gross**.

The **Bending Span Results** show the calculated eccentricities, **ecc. In** and **ecc. Out**, due to the ultimate moment in or out of plane divided by the ultimate axial load. The neutral axis depth for bending in and out of plane are listed as **NA In** and **NA Out** respectively. These neutral axis locations are always given with respect to the geometric center of the column. Also shown in this section are the unreduced nominal moment capacities, **Mn Out** and **Mn In**, for each span of the column. If the **PCA Load Contour Method** is used, **Mno Out** and **Mno In** are given, representing the maximum allowable moment for uniaxial bending at the nominal axial strength, **Pn** (see [Biaxial Bending of Columns](#)). If the **Exact Integration Method** is used, these values will be left blank.

The **Shear Steel** section of the report shows each span of the column broken into one or more shear regions and the number, size, and spacing of shear stirrups required in each of those regions is given. The shear design for columns is the envelope of all the shears for both directions.

The **In Plane and Out Plane Shear Span Results** show the nominal shear strength, **Vn In** and **Vn Out**, in each shear region of the column followed by the nominal shear strengths of the concrete, **Vc In** and **Vc Out**, and the nominal shear strengths of the steel, **Vs In** and **Vs Out**. The area of shear reinforcement required in each shear region of the column is shown as **As In Reqd** and **As Out Reqd**. The area of shear reinforcement provided in each shear region of the column is shown as **As Prvd**. Shear demand and concrete capacity are shown for both directions, but only one design of shear ties is used. Thus the **As_reqd** may vary for each side, but the **As_prvd** will always be the same.

Magnified Moments / Slenderness Effects

Span	KL/r yy	KL/r zz	Cm yy	Cm zz	Lu yy (ft)	Lu zz (ft)	Mcy (k-ft)	Mcz (k-ft)
1	16	134	-1	.6	5.375	45		142.6104
2	12	134	.6157	.6157	4	45		49.0923

The **Slender Bending Span Results** give the ultimate moments in and out of plane amplified for the effects of member curvature, **Mc Out** and **Mc In**. These values will be left blank for spans that do not meet the criteria for slender columns in the specific direction. Also shown in this section are the values **KL/r** in and out of plane, followed by the equivalent moment correction factors **Cm Out** and **Cm In**. The unbraced lengths of the column for each span and each direction, **Lu Out** and **Lu In**, are given as well.

For Non-Sway frames, the assumption is that $EI = 0.25 * E_c * I_g$. This is equivalent to setting B_{dns} to 0.6 in ACI 318-14 Equation 6.6.4.4.4c (ACI 318-11 Equation 10-15). For sway frame columns with a **KL/r** value greater than 22, the moment amplification is applied to the total moment rather than the "non-sway" portion of the moment.

Warning Log Messages will be produced when the following occurs:

- If the **KL/r** for the column exceeds 100 per Section 10.11.5 of ACI 318-05. Note this message only occurs for 2005 and older codes.
- If a slender member is classified as being part of a Sway frame, but a P-Delta analysis was NOT performed. For sway frames this P-Delta requirement applies anytime the slenderness ratio **KL/r** exceeds 22.

Customizing RISA-2D

You may customize many of the default parameters, design and analysis options in RISA-2D. In this way you can modify the program so that it best suits you and your work processes. All customization may be defined or redefined at any time. The **Application Settings** option on the **Tools Menu** provides you control over the behavior of the software. The **Save as Defaults** feature allows you to specify the default settings for new model files. These features are discussed below. Custom reports may also be defined and saved for future use. See [Printing](#) to learn how to build a custom report.

Save as Defaults

You may use the **Save as Defaults** feature in the following dialog boxes by entering the default information in the dialog and clicking the **Save as Defaults** button: **Model Settings, Units**, and **Drawing Grids**. This will cause the program to use these settings with any new files that are then created.

Many of the spreadsheets also provide the option to save the current data as the default and every subsequent new file will already have that data. Simply enter the data you want then save it as the default by clicking on the  button. This way the office standards that you might use in most of your models are already entered and available in new models. This feature is available in the following spreadsheets: **Materials, Custom Wood Species, Design Rules, Footing Definitions**, and **Load Combinations**.

Once you create a new file you may redefine any of the default data and settings for that particular file so the **Save as Defaults** feature may be used to give you a good starting point for new files but won't hold you to those settings.

Application Settings (Preferences)

Program options may be accessed by selecting **Application Settings** from the **Tools Menu** and are divided into the five sections described below. Many of the Application Settings themselves are self-explanatory.

General Application Settings (Preferences)

The general Application Settings are straightforward. For help on an item click  and then click that item. It may be a good idea to disable the **Automatically refresh...** option when working with large files or slower computers. You may also set the backup timing. See [Automatic Backup](#) to learn about the backup capabilities of RISA-2D. The **Reset Customization Options** button will clear all of the Application Settings that you have set on any of the tabs.

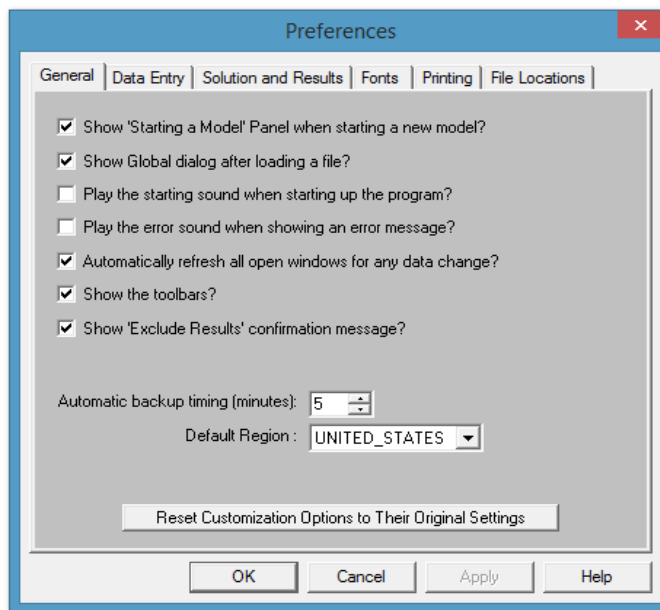

Show "Starting a Model" Panel when starting a new model – The New Model Dialog will be displayed when opening the program or selecting 'New File' from the File Menu.

Show Global dialog after loading a file – Displays the Model Settings settings automatically after loading a file.

Play the starting sound when starting up the program – A startup sound will be played when the program opens.

Play the error sound when showing error messages – An error sound will be played when an error is displayed.

Automatically refresh any open windows for any data change – Changes to the model will automatically be reflected in all windows – spreadsheets and model views. For large models you may want to limit the number of open windows or disable this feature altogether.

Show Toolbars – All toolbar commands may also be found in the menu system so if you want more work space you may disable the toolbars.

Show Exclude Results confirmation message – After solving the model you may use the Exclude Feature to graphically select items that you wish to see in the results spreadsheets, "excluding" other results. This enables a confirmation message warning you that some results are not shown.

Automatic backup timing – Automatic backup of the currently open model occurs at the specified interval. Each backup overwrites the previous one, such that only one backup of a given model exists at any time.

Maximum Number of Models to Backup - This controls how many models are kept in the backup folder. Once the folder becomes "full" according to this setting, the oldest backups will be deleted automatically. Setting this to zero turns off automatic backups.

Reset Customization Options – Choose this to return to the program defaults.

Default Region - Choose the default region for your projects.

Show detailing information in the model - Choose to display the Detailing information in the spreadsheets, draw dialogs and member information dialogs.

Data Entry Application Settings (Preferences)

To use bigger or smaller fonts in the spreadsheets you may adjust the row heights. You may also specify the number of decimal places that are displayed. The one exception is the **Joint Coordinates**. RISA-2D maintains the

coordinates to 15 significant figures and the exact value is always displayed. You may use the **Tools Menu** to round off joint coordinates.

If you wish to use a prefix with your joint, member, and plate labels, such as “J” with joints, you can specify the default prefix. These prefixes may be changed as you build your model.

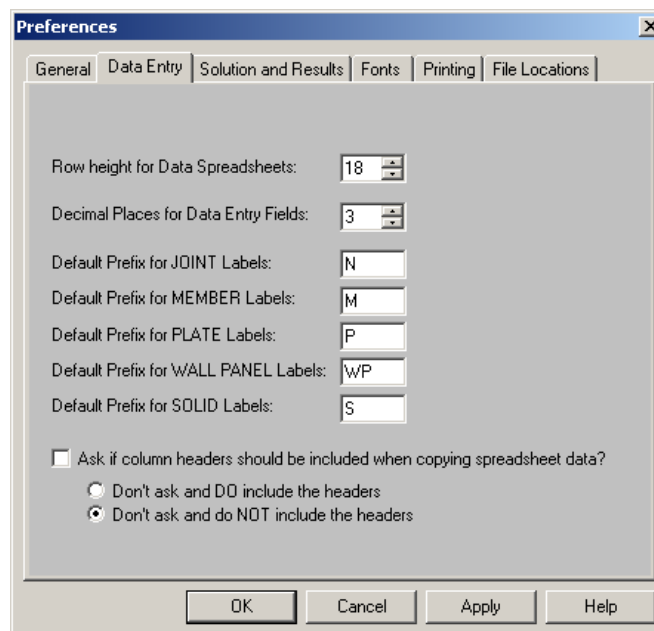

Row height for data spreadsheets – Sets the row height and font size for data spreadsheets.

Decimal places for data entry fields – Sets the number of decimal places to display in the data spreadsheets with a maximum of four places.

Default prefix for JOINT labels – Sets the default prefix to be used in joint labels.

Default prefix for MEMBER labels – Sets the default prefix to be used in member labels.

Default prefix for PLATE labels – Sets the default prefix to be used in plate labels.

Default prefix for WALL PANEL labels - Sets the default prefix to be used in wall panel labels.

Ask if column headers should be included when copying... - If this checkbox is checked then the program will ask if you want to copy the spreadsheet header any time you attempt a copy command in a spreadsheet. If this checkbox is not checked then you have the option of either always copying the spreadsheet headers, or never copying them.

Solution and Results Application Settings (Preferences)

At solution time RISA-2D finds and locks any instabilities to allow the solution to occur. See [Stability](#) to learn more about this. Rotational instabilities are commonly inconsequential and RISA-2D allows these instabilities to be locked without any warning.

RISA-2D can provide a warning when clearing results. To use bigger or smaller fonts in the results spreadsheets you may adjust the row heights. You may also specify the number of decimal places that are displayed. The number of figures displayed may not be the actual number. Behind the scenes RISA-2D maintains numbers to numerous decimal places.

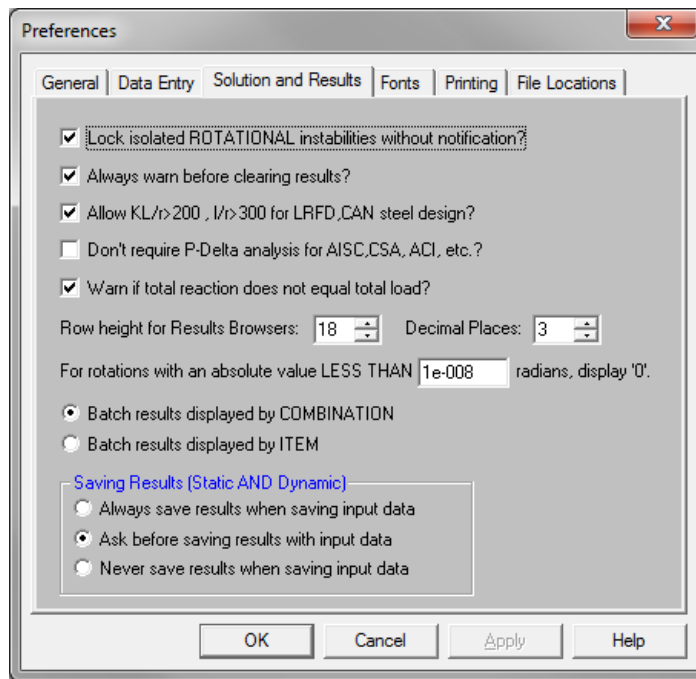

Lock isolated ROTATIONAL instabilities without notification? – Locks insignificant rotational instabilities at solution time without warning. This will cut down on joint instabilities that are technically unstable but in practice are unnecessary.

Note:

- If you are getting a Warning Log message that states "Sum of reaction is not equal to the sum of the loads", you may need to uncheck this box to look for instabilities in your model.

Always warn before clearing results? – Verifies that results are to be cleared to edit the model.

Allow $KL/r > 200$, $I/r > 300$ for LRFD, CAN steel design? – Waives the slender check for slender members.

Don't require P-Delta analysis for AISC, CSA, ACI, etc.? - Waives the [P-Delta](#) analysis requirement for certain design codes.

Warn if Total Reaction does not equal total load? - Enables a check in the program to confirm that the total applied load equals the sum of the joint reactions. See the [Warning Log](#) topic for more information on this.

For additional advice on this topic, please see the RISA Tips & Tricks website: www.risa.com/post/support. Type in Search keywords: **Sum of Reactions**.

Row height for Results Browsers – Sets the row height and font size for results spreadsheets.

Decimal Places – Sets the number of decimal places to display in the results spreadsheets with a maximum of four places.

Rotation Limits – Shows 0 for the rotation when smaller than this value.

Batch Results Display - The results of a batch solution may be grouped by load combination or by item. For example you can group results for all members under each particular load combination or you can group results from each combination under a particular member. The setting here is merely a preference. Once you have solved a model you can switch back and forth using the **Results Menu**.

Saving Results – These options let you control what is done with the results when saving a file.

Font Application Settings (Preferences)

The font Application Settings can be used to adjust the fonts used by the spreadsheets, results browsers, and graphics. The font changes will affect both the on-screen displayed data and the printed data. The exceptions to this are the spreadsheet and browser fonts which may be changed for on-screen display but are hard-wired for printing purposes.

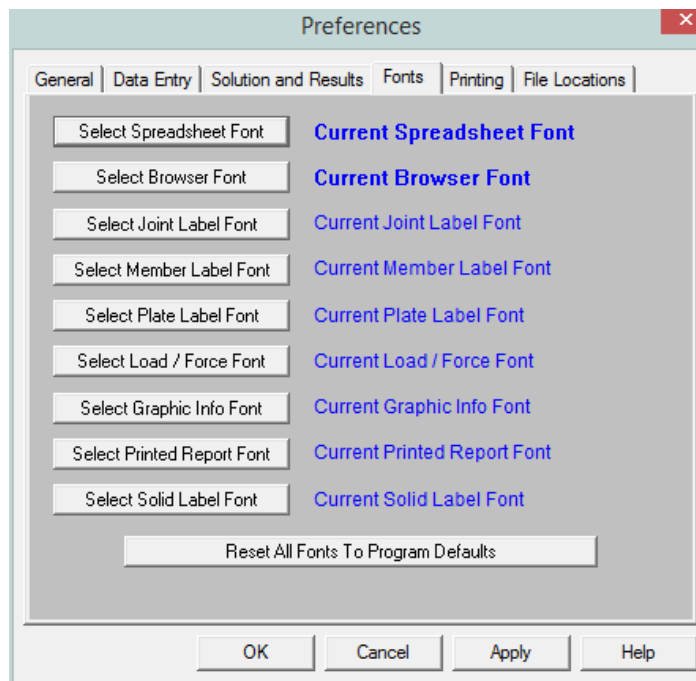

If the font data has been set to some unusual settings, then the user can click the **Reset All Fonts to Program Defaults** button to restore the fonts to what is normally expected for the RISA program.

Printing Application Settings (Preferences)

This tab gives many options for printing output. See [Printing](#) for additional information.

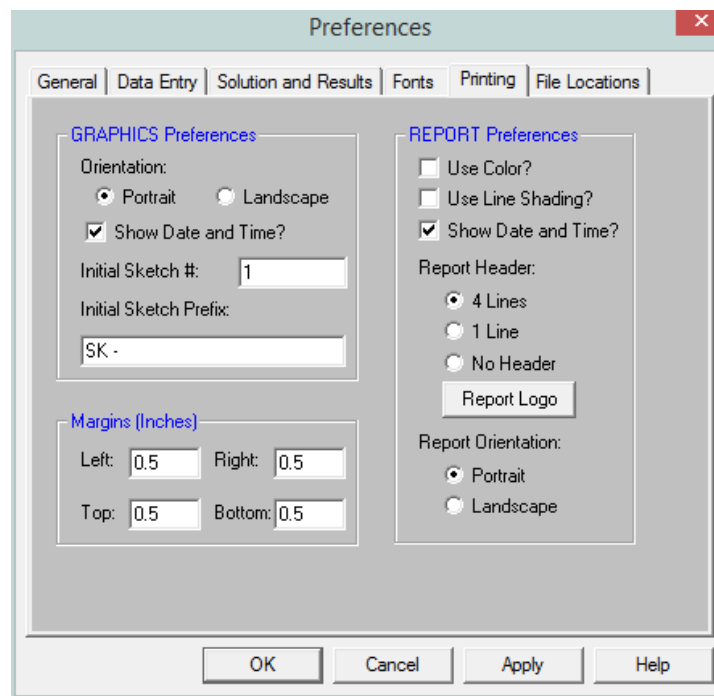

Orientation for graphics – Sets the default paper orientation for graphic printing.

Sketch Information - Sets sketch numbers and prefixes for graphic printing.

Margins – Sets the default printing margins.

Report Application Settings – These allow you to define information about colors, date and time, headers, report logo and overall report orientation.

Use Line Shading? - Defines whether the spreadsheet output shades every other line. This can give contrast to make the information easier to read.

Report Logo - Allows you to add either a RISA logo or any company logo to your printed output.

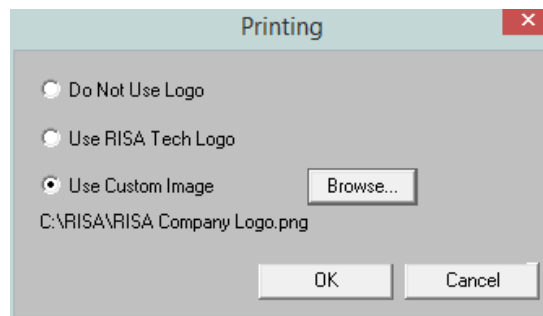

File Application Settings (Preferences)

The locations for data files, databases, temporary space, importing, and backing up may be specified separately by choosing from the list.

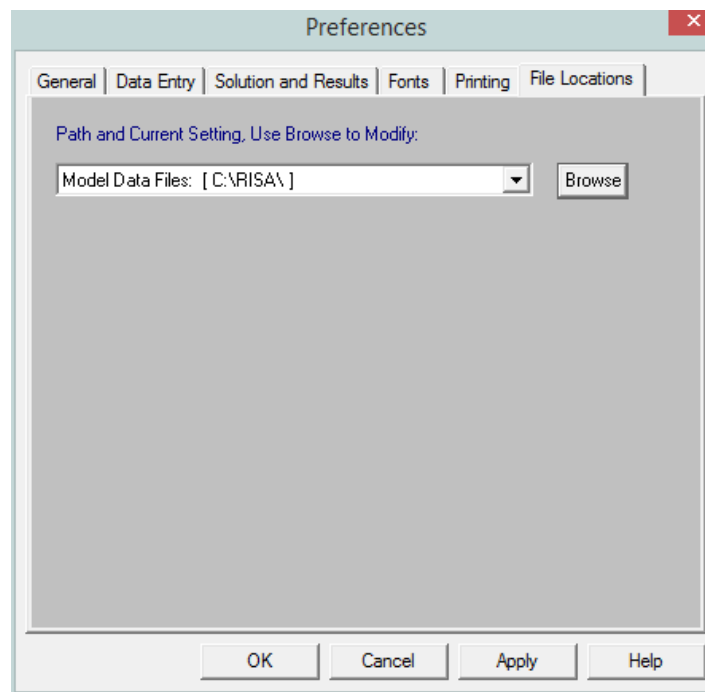

Path and current setting – For each file type in the list the current setting is displayed. Click the drop down list to view different file types. Click the browse button to choose a different location.

Member Design Optimization

RISA-2D will optimize Hot Rolled Steel, Cold Formed Steel, Wood, and Concrete members. The criteria used for this optimization are the selected design code and the **Design Rules** assigned to the member. The sizes are chosen from a Redesign List assigned to the member.

The **Member Design Rules Spreadsheet** records the parameters for the optimization. Optimization is performed for minimum weight, taking into consideration any depth, width, rebar limitations, etc. Note that the design rules input is one large spreadsheet, thus all of your design rules will be in the same place. Note that the dimensional rules and the reinforcement rules are all a separate entity. They have no interaction with each other in the program. They are simply all input into the same location. For example, your minimum member width rules will not be influenced by concrete beam reinforcement rules.

You can assign the design rules graphically as you draw members or later as a modification. See [Modifying Member Properties](#) for more information.

For additional advice on this topic, please see the RISA Tips & Tricks webpage at risa.com/post/support. Type in Search keywords: **Redesign**.

Wall Design Optimization

The program will also optimize concrete, masonry, and wood walls. For Wall Design Rule information see these topics:

- Concrete: [Concrete Wall - Design Rules](#)
- Masonry: [Masonry Wall - Design Rules](#)
- Wood: [Wood Wall - Design Rules](#)

Note:

- For the optimization procedure on concrete walls see [Concrete Wall - Design](#).
- For the optimization procedure on masonry walls see [Masonry Wall - Design](#).
- For the optimization procedure on wood walls see [Wood Wall - Design](#).

Member Design Lists

A **Design List** defines a set of member sizes that are considered when the program is suggesting member sizes. You may assign a Design List to a member based on Member Type. The design lists available for Column members may not match the design lists for Beam members, because some shapes are more appropriate for use as beams than as columns. You may edit these lists or create additional custom lists of your own. For more information on these redesign lists, including file format, editing procedure, and user defined lists refer to [Appendix A - Redesign Lists](#).

Member Design Rules – Size / U.C.

The **Design Rules Spreadsheet** records the limitations for the design and may be accessed by selecting **Design Rules** on the **Spreadsheets Menu**. You may create and name any number of design rules and assign different rules to various members.

	Label	Max Depth...	Min Depth...	Max Width...	Min Width[i]...	Max Bendi...	Max Shear...
1	Joists	12				1	1
2	Exterior Columns					.9	1
3	Interior Columns			16	16	.85	1
4	Girders	24	12			1	1

The spreadsheet has three tabs: **Size/UC**, **Deflection**, and **Concrete Rebar**. The entries for the **Size / UC** tab are explained below:

Design Rule Labels

You must assign a unique label to the design rules. You then refer to the design rule by its label when assigning it to members. The label column is displayed on all tabs of the spreadsheet.

Max/Min Depth

You may enforce depth restrictions by setting either a maximum and/or minimum depth.

Max/Min Width

You may enforce width restrictions by setting either a maximum and/or minimum width.

Max Bending and Shear Check

Enter the maximum bending and shear unity checks. This should usually be specified as "1". If you desire a larger factor of safety, provide a lower factor (i.e. ".95").

Member Design Rules – Deflection

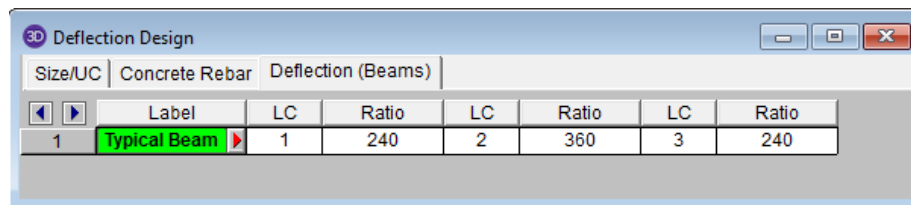

	Label	LC	Ratio	LC	Ratio	LC	Ratio
1	Typical Beam	1	240	2	360	3	240

This spreadsheet allows you to define deflection criteria for beams in the model. You must choose specific load combinations from the Load Combinations spreadsheet (up to three) and give the maximum deflection L/y criteria.

Note:

- In the [Load Combination Generator - Gravity tab](#) the program will create deflection load combinations for you automatically to match up with the defaults.
- If you write "None" in the **LC** column the program will ignore this criteria when checking deflections. If all three **LC** columns are defined as "None" then no deflection checking will be done for beams in the model.

Member Design Rules – Concrete Rebar

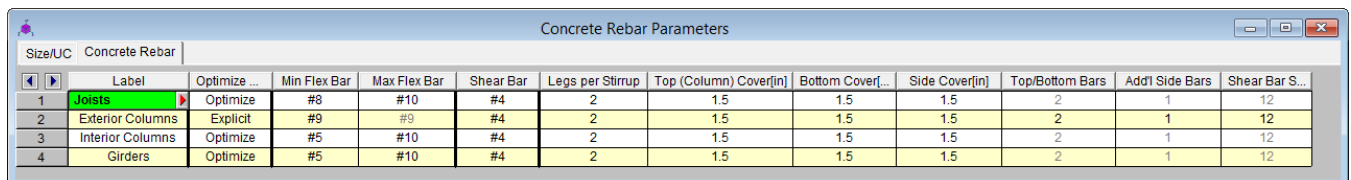

	Label	Optimize	Min Flex Bar	Max Flex Bar	Shear Bar	Legs per Stirrup	Top (Column) Cover[in]	Bottom Cover[...]	Side Cover[in]	Top/Bottom Bars	Add'l Side Bars	Shear Bar S...
1	Joists	Optimize	#8	#10	#4	2	1.5	1.5	1.5	2	1	12
2	Exterior Columns	Explicit	#9	#9	#4	2	1.5	1.5	1.5	2	1	12
3	Interior Columns	Optimize	#5	#10	#4	2	1.5	1.5	1.5	2	1	12
4	Girders	Optimize	#5	#10	#4	2	1.5	1.5	1.5	2	1	12

The entries for the **Concrete Rebar** tab are explained below.

Note

- If you would like to define specific flexural and shear rebar layouts for beams and columns, either use the **Explicit** option below or see [Rebar Layout Database](#) for Custom Rebar layout.

Optimize

The options in this column are **Optimize** and **Explicit**. **Optimize** indicates the program will find the most optimal size and spacing of the reinforcement. **Explicit** indicates the exact number of and size of reinforcement bars. When **Explicit** is selected the additional columns are editable and allow you to enter the quantity for **Top/Bottom Bars**, **Add'l Side Bars**, and **Shear Bar Spacing**. These columns are greyed out when **Optimize** is selected.

Flexural Bars

Use the **Min Flex Bar** and **Max Flex Bar** columns to restrict bar sizes for your flexural reinforcing. Currently we support the ASTM A615 (imperial), ASTM A615M ("hard" metric, i.e. #8M is an 8mm bar), BS 4449 (British), prENV 10080 (Euro), CSA G30.18 (Canadian), and IS 1786 (Indian) reinforcement standards. You may specify your rebar set in the [Model Settings - Concrete](#). You can force the program to analyze one bar size by setting the Min and Max values to be the same bar.

Shear Ties

Use the **Shear Bar** column to enter the size of your shear ties. Currently we support the ASTM A615 (imperial), ASTM A615M ("hard" metric, i.e. #8M is an 8mm bar), BS 4449 (British), prENV 10080 (Euro), CSA G30.18 (Canadian), and IS 1786 (Indian) reinforcement standards. You may specify your rebar set in the [Model Settings - Concrete](#).

Legs per Stirrup

Use the **Legs per Stirrup** column to enter the specific information about how many legs (2 to 6) each of your shear ties is expected to have.

Concrete Cover

The last three columns are used to specify the clear cover measured to the shear reinforcing. Note that the Top Cover is used for all sides of Column members.

Member Design Rules Editor

The **Member Design Rules Editor** provides a way to create or modify member design rules in a graphical way. This editor automatically updates any information input into the **Member Design Rules** spreadsheet.

Note:

- Keep in mind that this dialog has three tabs. Make sure to fill out the information on all the tabs before clicking **OK**.
- See the information in the Status Bar for more information on each of these entries.

The **Design Rule Label** is editable and will change the spreadsheet label. It is useful to name the design rule with a descriptive name like "First Floor Columns".

The **Member Type** listed is for reference of the picture only in this dialog. The member type will not control the Member Type of the beam or column which you will need to assign separately when the member is drawn.

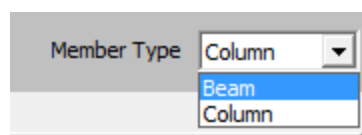

The Size/UC tab:

Member Design Rules Editor

Design Rule Label: Member Type:

Size/UC | Deflection (Beams) | Rebar

Min Width: in
Max Width: in

Min Depth: in
Max Depth: in

Max Bending Check:
Max Shear Check:

Top Reinforcing clear cover measured from shear bars

OK Cancel Help

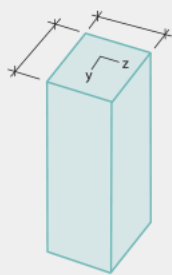

Member Design Rules Editor

Design Rule Label: Member Type:

Size/UC | Deflection (Beams) | Rebar

Min Depth: in
Max Depth: in

Min Width: in
Max Width: in

Max Bending Check:
Max Shear Check:

OK Cancel Help

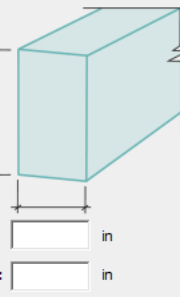

Deflection (Beams) tab:

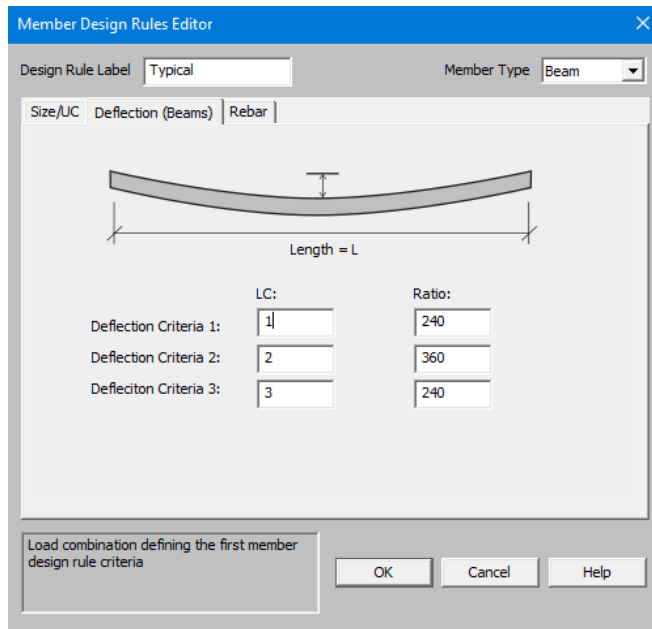
This only applies to Beam members.

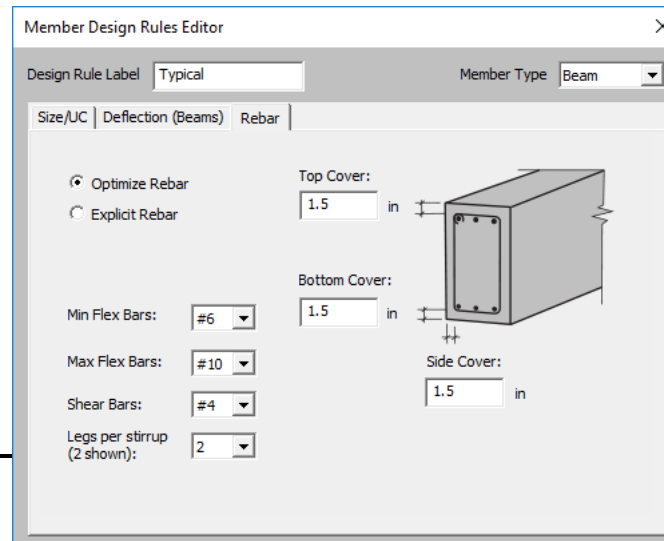
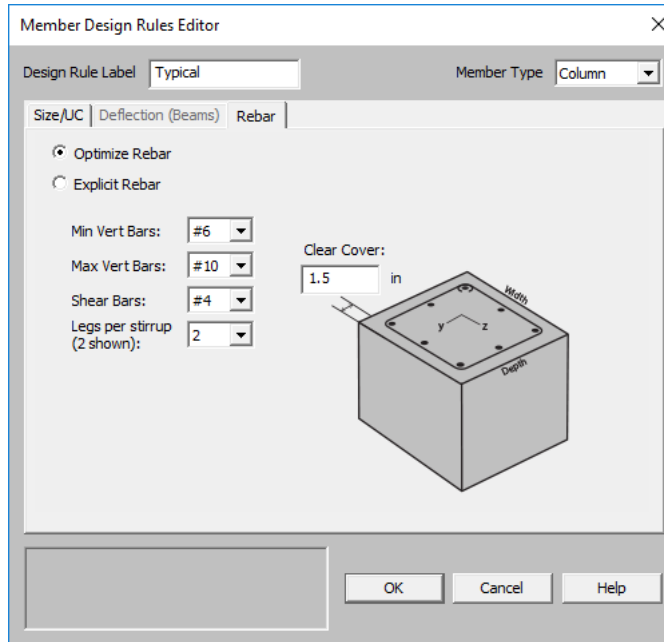

Rebar tab:

You can select **Optimize** or **Explicit** to set the rebar design parameters.



Accessing the Member Design Rules Editor

To access this editor you can click the red arrow on any tab in the **Member Design Rules** spreadsheet (click in the **Label** cell to make the red arrow appear).

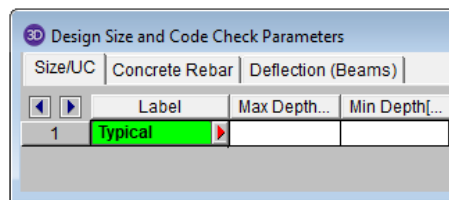

Member Optimization Procedure

Member optimization is performed both on explicitly defined members and on members defined through the use of Section Sets. Members defined as part of a Section Set are checked to determine which member has the highest code check value and which member has the highest shear check value. These members are considered to be the controlling members for that section set.

The controlling forces on a member or a section set are then applied to new shapes satisfying the redesign parameters and a code check is calculated. If the calculated code check and shear check falls within the specified range the shape is considered to be an acceptable alternate.

Optimization Results

Suggested Shapes Spreadsheet

Access the **Member Suggested Shapes** spreadsheet by selecting the **Results Menu** and then selecting **Members** ▶ **Suggested Design**. Alternatively you can click the **Suggested Design** button on the **Results** floating toolbar.

	Section Set/M...	Current Shape	Suggested Shape	Controlling Member	Controlling Criteria	Use Suggested?
20	M151	HSS8x6x3	HSS7x7x4		Strength	<input checked="" type="checkbox"/>
21	M152	HSS8x6x3	HSS7x7x4		Strength	<input checked="" type="checkbox"/>
22	M49	W8x10	W16x31		Beam Deflection	<input checked="" type="checkbox"/>
23	M134	W8x10	W12x19		Beam Deflection	<input checked="" type="checkbox"/>
24	M135	W8x10	W16x26		Beam Deflection	<input checked="" type="checkbox"/>

These are the suggested shapes resulting from the optimization calculations. They are chosen from each member's assigned [Design List](#). The suggested shape is *estimated* to most closely meet the criteria specified in the [Member Design Rules](#) without exceeding them. If the member is a "Beam" member type then the **Controlling Criteria** could be based on either strength criteria or deflection criteria.

Note:

- The suggested shape may be larger or smaller than the current shape, except for the case of members brought over from RISAFloor, for which the program never recommends downsizing.

To confirm that these alternate shapes are acceptable you **MUST** adopt any changes into the model then re-solve and check the results. The suggested shapes are based on the forces for the current model. Keep in mind that the current results are based on the stiffness of the current shapes. Changing the shapes will change the stiffness, which is why the model needs to be resolved. It may be necessary to cycle through this process a few times to achieve the best shapes.

You may try the new shapes by clicking the **Replace and Resolve**  button. The shapes listed in the **Suggested Shapes** column will only be used to update the model if the "Use Suggested?" box is checked for that particular member or section set.

If the message "No Shapes Found" is given, then no satisfactory shapes could be found in the Design List specified for that member or section set. This can occur for a number of reasons. Common reasons are:

- The loads applied are too large for the shapes in the redesign list.
- No load combinations were checked for the design of this material type. See [Load Combinations - Design Tab](#) for more information.
- A code check could not be performed for a member in the section set. See the Code Check spreadsheet or the [Warning Log](#) for these members.
- The member has not been assigned an initial redesign list. Check the Members and Section Sets spreadsheets to be sure they are defined with a redesign list.
- On-line shapes (RE, PI and BAR) cannot be redesigned.
- If you've entered a minimum code check value and the members assigned to this section set are lightly loaded, it is possible that no shape generates a code check value high enough to exceed the minimum.
- A code was not specified for that material on [Model Settings - Codes](#).

Note:

- For masonry wall design optimization see the [Masonry Wall - Design](#) topic.
- For wood wall design optimization see the [Wood Wall - Design](#) topic.

Drift

You may calculate and report inter-story drift based on calculated displacements in the X-direction.

Drift Definitions Spreadsheet

The Drift Definitions spreadsheet defines where the drift calculations will be performed. Drift calculations may be performed at specific elevations. However, these elevations must be manually entered by the user in the Drift Definitions spreadsheet. These elevations are defined with respect to the vertical axis of the model.

In addition, the user may specify individual to be used in drift calculation. definitions are included for a number of reasons. They allow models defined in older versions of the program (which only used defined "story joints") to produce identical drift results in the current version. They also allow users to get drift reporting at specific points of interest even if these points don't line up well from floor to floor or don't behave the same as other at that elevation. See [Drift Modeling Tips](#) for more information.

Note

- Elevations are treated interchangeably for drift calculations. must be in exactly the same location on the upper and lower floors for drift to be calculated.
- When Elevations are entered manually, there **MUST** be defined at that elevation.
- When definitions are used, the drift calculation for the is based only on the defined. Therefore, you must also create a definition for the story below (unless it is at zero ft) in order to get correct behavior.
- The **Drift Definitions** spreadsheet is currently applicable to rigid diaphragms only.

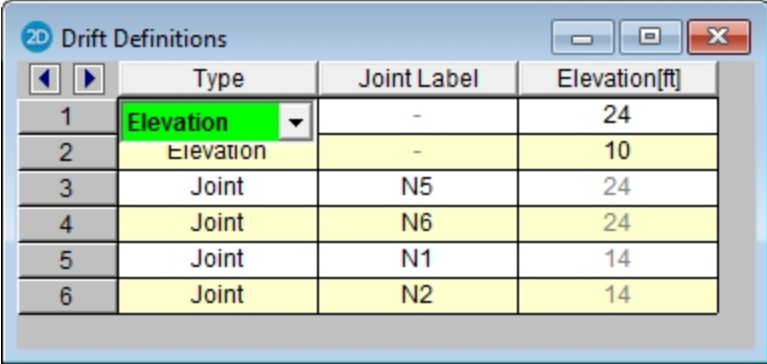

	Type	Joint Label	Elevation(ft)
1	Elevation	-	24
2	Elevation	-	10
3	Joint	N5	24
4	Joint	N6	24
5	Joint	N1	14
6	Joint	N2	14

To Define an Elevation for Drift Calculation

- On the Drift Definitions specify **Elevation** as the Type of drift definition you are creating.
- Enter the value for the elevation.

Note

- The program will also assume a default base elevation of 0. This will NOT be done if there are any drift definitions defined for elevations below 0.

To Define a for Drift Calculation

- On the Drift Definitions specify as the Type of drift definition you are creating.
- Enter the label.

Note

- This will be included in the drift calculations for both horizontal deflections.

For additional advice on this topic, please see the RISA Tips & Tricks webpage at risa.com/post/support. Type in Search keywords: **Story Drift**.

Drift Results

Once the solution is performed you may view the drift results in the **Story Drift** spreadsheet. Access the **Story Drift** spreadsheet by selecting it from the **Results** menu. This report lists the drift for all defined Diaphragms, Elevations and that exist in the Drift Definitions spreadsheet. The results are reported in the order in which they appear in the Drift Definitions spreadsheet.

Story (Elevation)	Story Drift [in]	Loc (Z,X)	LC	Drift Ratio	2nd/1st Ratio
1 24 ft	max -0.279	0, 20	2	.097	1.003
2	min -0.279	0, 20	2	.097	1.003
3 N5 (24 ft)	max -0.083	0, 6	2	.069	1.003
4	min -0.083	0, 6	2	.069	1.003
5 N6 (24 ft)	max -0.083	0, 20	2	.069	1.003
6	min -0.083	0, 20	2	.069	1.003
7 N1 (14 ft)	max -0.196	0, 6	2	.117	1.004
8	min -0.196	0, 6	2	.117	1.004
9 N2 (14 ft)	max -0.196	0, 20	2	.117	1.004
10	min -0.196	0, 20	2	.117	1.004

To calculate inter-story drift for a particular direction, the displacement at the lower level is subtracted from the current story displacement. For example, to calculate X direction drift for story 2, the X displacement for the representing story 1 is subtracted from the X displacement for the representing story 2.

For Elevation definitions, the drift calculations are only done at locations where columns or walls have at the current level and at the level below.

For Definitions, the calculations are done for the current defined drift compared to the nearest defined drift at a the level below. definitions never look at the in a Elevation definition. These are user-defined drift which act completely independent of the more automated Diaphragm and Elevation drift results and offer flexibility for cases where the Elevation options don't give the output needed.

For story height, the vertical axis is used to determine the distance. For example, the story Y coordinate values are used to calculate heights for X direction drift.

The base elevation of the structure is assumed to be zero. If the 0 ft elevation should NOT be used as the base of the structure for drift calculations, then the user should enter in an Elevation entry in the Drift Definitions spreadsheet to define the elevation of the base of the structure. This applies whether the base is a positive or negative value. If the value is positive, then there will be a reported drift (probably zero) at the base elevation that can be ignored by the user.

Service level and strength level drifts are reported on different tabs of Drift Results Spreadsheet. This is because seismic drift checks are usually checked purely for the strength level Load Combinations while wind drift is usually checked against service level Load Combinations.

Story Drift and Drift Ratio %

The Drift at a given level is equal to the deflection at that level minus the deflection at the level below. For the image below:

$$\text{1st Level Drift} = X_1$$

$$\text{2nd Level Drift} = X_2 - X_1$$

The Drift Ratio (%) is equal to the drift at that level divided by the height from that level to the level below. For the image below:

$$\text{1st Level drift ratio \%} = (X_1 / H_1) * 100\%$$

$$\text{2nd Level drift ratio \%} = ((X_2 - X_1) / H_2) * 100\%$$

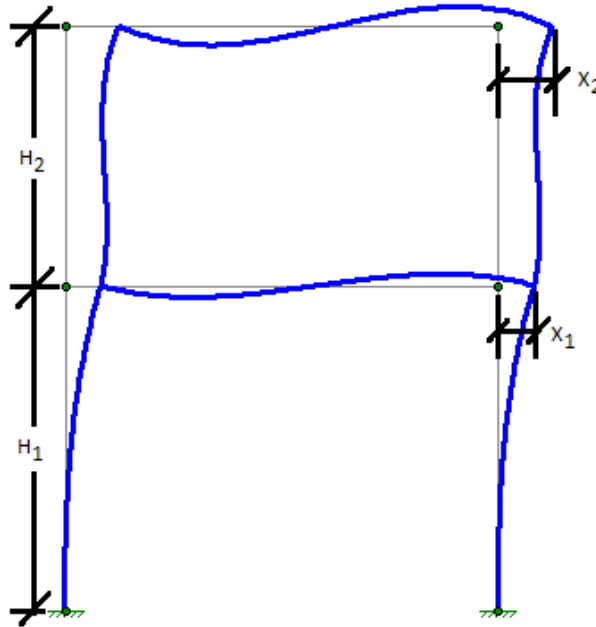

Seismic Drift Checks

Seismic drift are reported for all codes for load combinations containing earthquake loads, but the program will report failures in red text for the ASCE 2005, 2010, and 2016 codes based on the following table of allowable seismic drift versus Risk Category / Occupancy Category:

Drift Category	I or II	III	IV
High Drift Design	2.5%	2%	1.5%
Masonry Cantilever	1%	1%	1%
Other Masonry	0.7%	0.7%	0.7%
Other	2%	1.5%	1%

When the ASCE and IBC codes are used, the Story Drift for the strength level combinations will account for the inelastic deflection (i.e. the C_d factor) by amplifying the deflections at each level by C_d / I per Section 12.8.6 of ASCE-7. Where C_d is the Deflection Amplification factor intended to convert the elastic deflection levels given in the analysis to the inelastic levels used for seismic drift checks. Similarly, I is the importance factor (based on Risk / Occupancy Category) which was presumably used to amplify the seismic forces applied to the structure.

For codes other than the US codes the drift results are not modified for C_d , I or ρ , and are never reported in red text to indicate a failure.

Note

- These seismic checks are only performed for strength level load combinations.
- Stiffness reduction (per AISC Direct Analysis Method) does NOT change the drift code checks in RISA even though it may cause significant increase the reported drift.
- Load Combinations with Overstrength (Ω) seismic loading are not included in the drift reporting at all.
- To negate the effect of the redundancy factor (ρ), the deflection results are divided by ρ before drift calculations are performed. This only occurs, of course, for load combinations where ρ was used to amplify the seismic loading. This is done because the redundancy factor is not intended to affect story drift calculations per section 12.3.4.1 item 2 of ASCE-7 2016.

2nd Order / 1st Order Deflection Ratio

The program will report the ratio of 2nd order deflection to 1st order deflection for the used in the drift calculation. This is useful when determining whether it is required by the AISC code to use the Direct Analysis Method. In general, if the ratio is greater than 1.5 (or 1.7 if stiffness adjustment has been turned on) then you MUST use the Direct Analysis Method on your structure.

To facilitate this check, RISA will color the check in red whenever the ratio exceeds the 1.5 limit (or 1.7 when stiffness adjustment is used). This is done regardless of what has been chosen for the HR steel code. While the 1.5 or 1.7 may not be a code trigger in other HR steel codes, it remains because it can be an indicator of when 2nd order effects become troublesome.

There is an internal tolerance of 0.0005 inches, below which the deflection will not be reported in drift results. This is because while the drift is essentially zero, testing showed cases where minor increases in these small values could result in high 2nd order / 1st order deflection ratios. Which were falsely indicating 2nd order effects as reaching high or troublesome levels.

Drift Modeling Tips

Inclined Columns

When using elevations, the drift is reported for aligned connected by columns or walls. This doesn't help for inclined columns because those will very specifically NOT align from level to level. If drift reported is required for these, then they should be defined using the option instead. When defined this way, the drift from level to level will be reported based on the nearest at the level below.

Multi-Story Columns

In the image below, N2_3 should have its drift calculated based on a story height that is twice what the other at that level would be based on. In that case, the user should use Elevationdefinitions for the majority of the, but use definitions for N2_3.

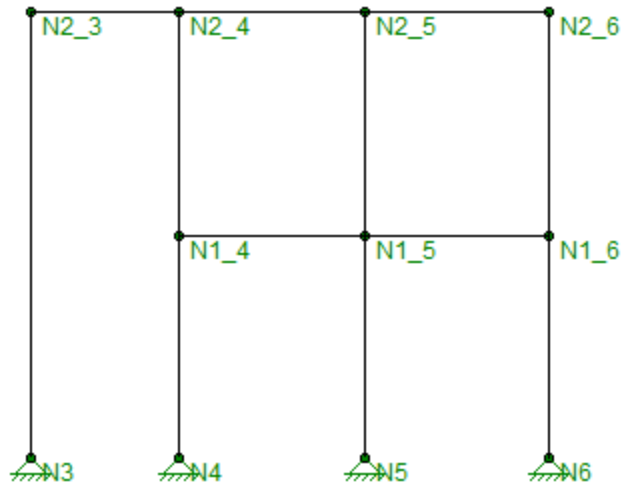

Troubleshooting NC results

There are times when drift results will be reported as "NC" (which stands for Not Calculate). This can occur for a number of reasons:

- The Story Drift for that floor is below the 0.005" minimum tolerance for reporting.
- When there are no aligned drift between that elevation and the one below.
- The 2nd / 1st Ratio will report NC for any load combinations where a P-Delta analysis was not included in the solution.

DXF Files

You may read and write export DXF files. Generally, you would read in a DXF file to create the geometry for a new structural model, or you could write out a DXF file from an existing model to form the basis for a model or a CAD drawing. This feature provides two-way compatibility with any other program that can read and write DXF files. This includes most major CAD programs and many analysis programs.

Note

- Perform a Model Merge on any model created from a DXF file. See [Model Merge](#) for more information.
- You may want to round off the joint coordinates after importing a DXF file. You may do this from the Tools menu.
- When importing a DXF file it is essential to specify a column layer. Only beams that are fully supported will be imported.
- You can also import a DXF as a Drawing Grid. See the [Import DXF](#) section of the Graphic Editing topic for more information.

Importing DXF Files

You may translate POINT's, LINE elements and 3DFACE's. POINT's are converted into joints, LINE's are converted into members and 3DFACE's are converted into plates. Circles, arcs, polylines, text, etc. may be present in the DXF file, but these will be ignored. At this time, only the basic geometry will be translated via DXF files. You have several options available for controlling how DXF files are imported. They are as follows:

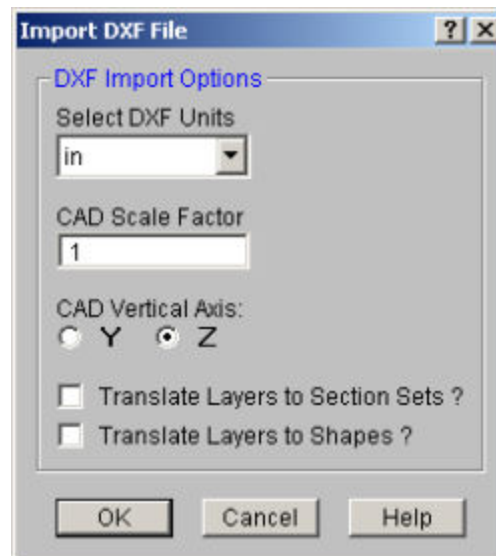

DXF Units

Select the units you used in the CAD model from which you produced the DXF file. The supported DXF units are none, inches, feet, mm, cm, and meters.

CAD Scale

Enter the scale factor that will cause the DXF file to be scaled up or down to full scale. For instance, if you had created a scaled model in AutoCAD at a scale of 1/4"=12", then the appropriate scale factor to produce a full size RISA-2D model would be 48. The default is 1.0.

DXF File Vertical Axis

Although it is not specifically noted in the AutoCAD documentation, the implied default vertical axis is the positive Z-axis of the current User Coordinate System.

The default vertical axis in RISA is usually the positive Y-axis and may be specified in the **Model Settings** under the **Axis** Tab. When you import your model from a DXF file, you can have the program automatically rotate your geometry so that the Y axis is now the vertical axis for your RISA model.

Translate Layer Names to Section Sets

This is a Yes/No check box. If you check the box "Yes", the program will translate the DXF file's layer names into RISA Section Sets Labels. The program requires that you add a prefix to each Layer Name to designate what type of material that section set is defined for. The prefixes are as follows:

Material Type	Layer Prefix
Cold Formed Steel	CF_
Concrete	CN_
Hot Rolled Steel	HR_
General Materials	GN_
Wood	WD_

For example, let's say you have designed a structure with Hot Rolled steel section sets that you want to call "Column" and " Girder", as well as a Wood section set called "Joist". If you do not prefix your section sets then they will all be imported as General Material section sets. To have them imported into the proper Material type the column layer would have to be named "HR_Column", the girder a layer "HR_Girder", and the joists layer "WD_Joist".

Translate Shapes to Layer Names

This is a Yes/No choice. If you choose "Yes", the program will take members and assign them to a shape based on their shape label. If there is not a database shape that corresponds to the DXF Layer Name, then these member will be assigned a general RE4x4 shape or a BAR2.

Note

- When assigning layer names in AutoCAD, remember to use an underscore character ("_") in place of a period (".") where a period would normally occur. For instance a C10X15.3 should be entered as C10X15_3. RISA-2D will automatically convert the "_" to a "." when the DXF file is read in.

Exporting DXF Files

Only the joint, member, wall and element geometry will be translated and used to create an ASCII DXF file. Any other information such as the boundary conditions, loads, member end releases, etc. will not be translated at this time. You have several options available for controlling how DXF files are exported as follows:

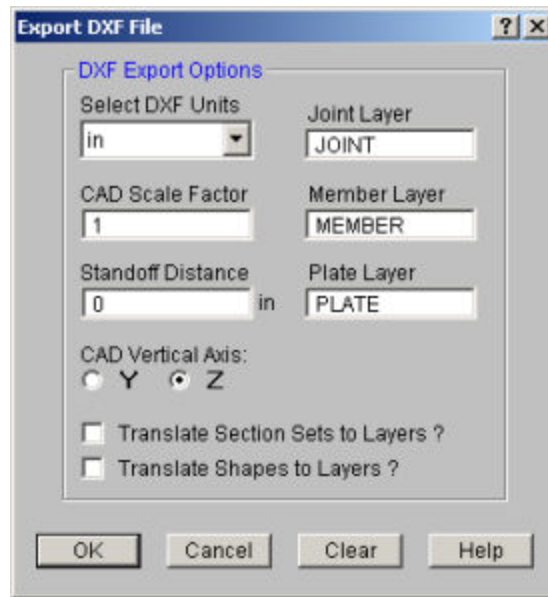

Joint Layer

Type the name of the layer for the joint point entities. If you don't enter anything, the default layer name will be "MODEL".

Member Layer

Type the name of the layer for the line entities. If you don't enter anything, the default layer name will be "MODEL". Note that this entry will be ignored if you select the option below to translate section set database shape names into layer names.

Plate Layer

Type the name of the layer for the plate elements, which will be represented as 3DFACE entities. If you don't enter anything, the default layer name will be "MODEL".

DXF Units

Select the units you desire the CAD model to be created in. The options for the DXF units are none, inches, feet, mm, cm, and meters.

CAD Scale

Enter the scale factor that will cause the full scale RISA model to be scaled up or down to the desired drawing scale. For example, if you created a full scale model that you wanted scaled down to 1/4"=12", the factor would be 0.020833, which is (.25/12).

Line End Standoff Distance

Enter the distance you wish to have the line entities "stand off" from the joints to which they are attached. The standoff distance is measured along the axis of the line. The distance will be in the DXF units, which is defined below. The distance will be used as entered and will not be scaled by the CAD Scale factor.

Note that if you create a DXF file with a non-zero standoff distance, it will be difficult to use the file for model geometry if you read the file back into RISA. (If you read such a file back in, you will end up with multiple joints at each member endpoint which will be separated by the standoff distance)

DXF File Vertical Axis

Although it is not specifically noted in the AutoCAD documentation, the implied default vertical axis is the positive Z-axis of the current User Coordinate System.

The default vertical axis in RISA is usually the positive Y-axis and may be specified on the **Model Settings**. When you export your model to a DXF file, you can have the program automatically rotate your geometry to match the vertical axis of your CAD program.

Translate Section Sets to Layer Names

This is a Yes/No check box. If you check the box "Yes", the program will translate Section Set Labels to layer names. Layers will be created in the DXF file corresponding to the section set labels in the RISA model. A "Yes" choice here overrides any layer name entered for the member layer.

The program will add a prefix to each section set layer to designate what type of material that section is. The prefixes are as follows:

Material Type	Layer Prefix
Cold Formed Steel	CF_
Concrete	CN_
Hot Rolled Steel	HR_
General Materials	GN_
Wood	WD_

For example, let's say you have designed a structure with Hot Rolled steel section sets called "Column" and "Girder", as well as a Wood section set called "Joist". If you type in a member layer name such as "STEEL" then all members, regardless of size, will appear on a layer named "STEEL". However, if you choose "Yes" for the *translate section sets to layers* option, then all the member that are assigned to the Column section set will appear on a layer named "HR_Column", the girders on a layer named "HR_Girder", and the joists on a layer called "WD_Joist".

Translate Shapes to Layer Names

This is a Yes/No choice. If you choose "Yes", the program will take members and assign them to a layer which uses their shape label as the layer name. Layers will be created in the DXF file corresponding to the shape labels in the RISA model. A "Yes" choice here overrides any layer name entered for the member layer.

Note:

- If you check BOTH the *Translate Section Sets* and *Translate Shapes* boxes, then only the explicitly defined shapes will be put placed on a layers according to their shape labels. All members defined with section sets will still be placed on layers according to their section set label.
- Please note that if the section set database shape designation includes one or more decimal point (".") characters, the export will translate each occurrence of a decimal point character into an underscore ("_") character. For instance, a section set or shape label such as a C10X15.3 will translate into a layer name of "C10X15_3" or "HR_C10X15_3".
- The DXF format does not properly recognize certain ASCII text characters for layer names (< > / \ " : ; ? * | = '). Therefore, these characters should be avoided for shape or section sets when using the "translate to layer names" options.

Merge After Importing a DXF File

It's always a good idea to do a Model Merge on any model created from a DXF file! In the process of creating a wire frame model in your CAD software, certain events may take place that cause end-points of LINE elements that were once matched to become mismatched by very small amounts. This most often happens as a result the following:

- Use of mirroring or rotating operations.
- Improper use or lack of use of point snaps.
- Trimming or breaking operations.
- Inconsistent precision when inputting point coordinates from the keyboard.

Model Merge combines joints that are within the “merge tolerance” distance of one another. The default distance for the merge tolerance is 0.01 ft. for all unit types.

You can also deal with several other possible problems by performing a **Model Merge**. This feature will also deal with intermediate joints along member spans, a common problem in models created from DXF drawings and members that cross, but do not have joints at their intersection point. See [Model Merge](#) for more information.

DXF Element Numbers

Different CAD packages handle ordering of geometric data in their DXF files in two basic ways.

Method 1:

Entities are written out into the DXF file based on the order in which they were created within the CAD program itself regardless of the order in which they were selected at the time the DXF file was made. Different operations such as copying, mirroring, arraying, etc. can produce unexpected results and it therefore becomes necessary to consult your CAD program documentation to understand how it stores and orders the geometry that you create via these various operations.

Method 2:

Entities are written out into the DXF file based on the order in which they were selected at the time the DXF file was made. AutoCAD is such a program. In order to control the ordering of the LINE entities, you must select the "Entities" option under the DXFOUT command and then select the lines in the order that you want them to appear in the RISA model.

Note

- Another option to help improve the ordering of the joints, members and elements in a model obtained from reading in a DXF file is to sort and relabel them once in RISA.

DXF File Format

The specific DXF file that you may read and write is the ASCII Drawing eXchange Files (DXF) file. Please note that AutoCAD has several different forms of DXF files available. ASCII is the default form and is the only form currently supported. The DXF read/write feature was written based on the DXF documentation for AutoCAD release 14. The feature has been tested with AutoCAD Versions 13 and 14.

The following is a short excerpt of the AutoCAD ASCII DXF format. This information is provided to help you debug any problems you may be having with DXF files that you are trying to read. For more complete information, consult your CAD documentation.

General

A DXF file is composed of sections of data. Each section of data is composed of records. Each record is stored on its own line. Each particular item is stored as two records, the first record is a group code and the second record is the data or a keyword. RISA only reads the ENTITIES section.

Group Codes

Each 2 record item start with an integer group code. RISA recognizes the following group codes:

Group Code	Description
0	Identifies the following overall keywords: SECTION, ENDSEC, and EOF. Within the ENTITIES section it also identifies POINT, LINE, and 3DFACE.
2	Identifies a section name (i.e., ENTITIES)
8	Identifies a layer name.
10, 11, 12, 13	Identifies the X coordinate of the 1st, 2nd, 3rd and 4th points of an item.
20, 21, 22, 23	Identifies the Y coordinate of the 1st, 2nd, 3rd and 4th points of an item.
30, 31, 32, 33	Identifies the Z coordinate of the 1st, 2nd, 3rd and 4th points of an item.

First and Last Records for a DXF file

Each DXF file must start with the first record as the group code "0". The 2nd record must be the keyword "SECTION". Each DXF file must have the 2nd to last record as the group code "0". The last record must be the keyword "EOF".

Entities Section

The ENTITIES section will be identified by a group code of "0", followed in the next record by the keyword "SECTION". The next record will be the group code 2, followed in the next record by the keyword "ENTITIES".

Item Formats within the ENTITIES Section

The POINT format is started by a group code of "0" followed by the keyword "POINT". The layer name for the POINT will start with a group code record of 8, followed by a record with the actual layer name.

The coordinates for the point will be started by the 10, 20, and 30 group codes respectively for the X, Y, and Z coordinates. Other group codes and data may be present within the POINT data but these will be ignored.

The LINE format is started by a group code of "0" followed by the keyword "LINE". The layer name for the LINE will start with a group code record of 8, followed by a record with the actual layer name.

The coordinates for the first point will be started by the 10, 20, and 30 group codes respectively for the X, Y, and Z coordinates. The coordinates for the second point will be started by the 11, 21, and 31 group codes respectively for the X, Y, and Z coordinates. Other group codes and data may be present within the LINE data but these will be ignored by RISA-2D.

The 3DFACE format is started by a group code of "0" followed by the keyword "3DFACE". The layer name for the 3DFACE will start with a group code record of 8, followed by a record with the actual layer name.

The X, Y, and Z coordinates for the 1st through 4th points will be started by the 10, 20, and 30 through 14, 24, and 34 group codes respectively. Other group codes and data may be present within the 3DFACE data but these will be ignored.

AutoCAD Layer Names

The only valid characters in an AutoCAD layer name are the letters A to Z, the numbers 0 to 9, and the three following characters: the dollar sign "\$", the underscore "_", and the dash "-".

Dynamic Analysis - Eigensolution

The dynamic analysis calculates the modes and frequencies of vibration for the model. This is a prerequisite to the response spectra analysis, which uses these frequencies to calculate forces, stresses and deflections in the model. For more information, see [Dynamic Analysis - Response Spectra](#).

The process used to calculate the modes is called an eigensolution. The frequencies and mode shapes are referred to as eigenvalues and eigenvectors. Refer to the [Program Limits](#) section for information on the maximum number of modes that can be solved for in RISA. The program can also solve for an approximate type of eigenmode called a [Ritz Vector](#).

The dynamic analysis uses a lumped mass matrix with inertial terms. Any vertical loads that exist in the **Load Combination for Mass** will be automatically converted to masses based on the acceleration of gravity entry on the Solution tab of the Model Settings. However, you must always enter the *inertial* terms as Joint Masses.

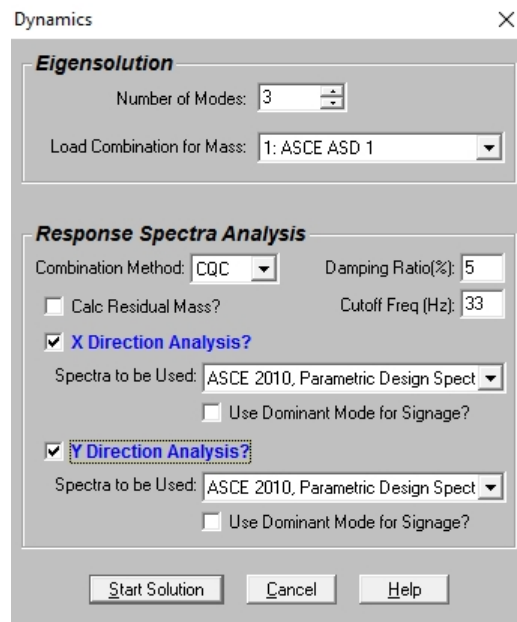

To Perform a Dynamic Analysis / Eigensolution

1. You may wish to solve a static analysis first to verify that there are no instabilities.
2. Click **Solve** on the main menu and select **Dynamics** from the solution options.
3. Specify the load combination to use as the mass and the number of modes to solve.

Note

- You may view the mode shapes graphically by choosing this option in the Model Display Options.
- Refer to [Dynamic Analysis - Response Spectra](#) for more information on that type of dynamic analysis.
- For information about the solver options (Standard, Accelerated and Ritz Vectors see the Model Settings - Solution tab Advanced options. For documentation information on these solvers see the [Solution](#) topic.
- See the [Residual Rigid Response](#) section for more information about the **Calc Residual Mass?** checkbox.
- See the [Dynamic Analysis - Response Spectra](#) topic for more information about the **Use Dominant Mode for Signage** checkbox.

Required Number of Modes

You may specify how many of the model's modes (and frequencies) are to be calculated. The typical requirement is that when you perform the response spectra analysis (RSA), at least 90% of the model's mass must participate in the solution. Mass participation is discussed in the [Response Spectra Analysis](#) topic.

The catch is you first have to do a dynamic analysis in order to know how much mass is participating so this becomes a trial and error process. First pick an arbitrary number of modes (5 to 10 is usually a good starting point) and solve the RSA. If you have less than 90% mass, you'll need to increase the number of modes and try again. Keep in mind that the more modes you request, the longer the dynamic solution will take.

Note

- If you are obtaining many modes with little or no mass they are probably local modes. Rather than asking for even more modes and increasing the solution time see [Dynamics Troubleshooting - Local Modes](#) to learn how to treat the unwanted modes.

Dynamic Mass

The eigensolution is based on the stiffness characteristics of your model and also on the mass distribution in your model. There must be mass assigned to be able to perform the dynamic analysis. Mass may be calculated automatically from your loads or defined directly.

In order to calculate the amount and location of the mass contained in your model, RISA takes the vertical loads contained in the load combination you specify for mass and converts them using the acceleration of gravity defined in the Model Settings. The masses are lumped at the joints and applied in both global directions (X and Y).

You may also specify mass directly. This option allows you to restrict the mass to a direction. You can also apply a mass moment of inertia to account for the rotational inertia effects for distributed masses. See [Loads - Joint Force / Displacement](#) to learn more about this.

Note

- Only the VERTICAL loads (including vertical components of inclined loads) contained in the load combination are converted to mass.
- The self-weight of the model is NOT automatically included in the mass calculation. If you wish to have self-weight included, you must have it defined as part of the load combination for mass.

Eigensolution Convergence

The eigensolution procedure for dynamic analysis is iterative, i.e. a guess is made at the answer and then improved upon until the guess from one iteration closely matches the guess from the previous iteration. The tolerance value is specified in the Model Settings and indicates how close a guess needs to be to consider the solution to be converged. The default value of .001 means the frequencies from the previous cycle have to be within .001 Hz of the next guess frequencies for the solution to be converged. You should not have to change this value unless you require a more accurate solution (more accurate than .001?). Also, if you're doing a preliminary analysis, you may wish to relax this tolerance to speed up the eigensolution. If you get warning 2019 (missed frequencies) try using a more stringent convergence tolerance (increase the exponent value for the tolerance).

Saving Dynamic Solutions

After you've done the dynamic solution, you can save that solution to file to be recalled and used later.

Note

- This solution is saved in a `._D` file and will be deleted when the Save or Save As options are used to overwrite the file. You may also delete this file yourself.

Work Vectors

When you request a certain number of modes for dynamic analysis (let's call that number N), RISA tries to solve for just a few extra modes. Once the solution is complete, RISA goes back to check that the modes it solved for are indeed the N lowest modes. If they aren't, one or more modes were missed and an error is reported.

Dynamics Modeling Tips

Dynamics modeling can be quite a bit different than static modeling. A static analysis will almost always give you some sort of solution, whereas you are not guaranteed that a dynamics analysis will converge to a solution. This is due in part to the iterative nature of the dynamics solution method, as well as the fact that dynamics solutions are far less forgiving of modeling sloppiness than are static solutions. In particular, the way you model your loads for a static analysis can be very different than the way you model your mass for a dynamic analysis.

The term "dynamics solution" is used to mean the solution of the free vibration problem of a structure, where we hope to obtain frequencies and mode shapes as the results.

In general, the trick to a "good" dynamics solution is to model the structure stiffness and mass with "enough" accuracy to get good overall results, but not to include so much detail that it take hours of computer run time and pages of extra output to get those results. Frame problems are simpler to model than those that include plate elements. "Building type" problems, where the mass is considered lumped at the stories are much easier to successfully model than say a cylindrical water tank with distributed mass. It is often helpful to define a load combination just for your dynamic mass case, separate from your "Dead Load" static case (You can call it "Seismic Mass"). Your seismic mass load combination will often be modeled very differently from your "Dead Load" static case.

Modes for discretized mass models with very few degrees of freedom may not be found by the solver, even if you know you are asking for fewer modes than actually exist. In this case it may be helpful to include the self weight of the model with a very small factor (i.e. 0.001) to help the solver identify the modes.

Self-Weight Considerations

Distributed mass models with plate elements, like water tanks, often require special consideration. You will want to use a fine enough mesh of finite elements to get good stiffness results. Often though, the mesh required to obtain an accurate stiffness will be too dense to simply model the mass with self-weight or surface loads. You will want to calculate the water weight and tank self-weight and apply it in a more discrete pattern than you would get using surface loads or self-weight. This method of using fewer joints to model the mass than to model the stiffness is often referred to as "discretizing" the mass. You want to lump the mass at fewer points to help the solution converge faster, however you have to be careful to still capture the essence of the dynamic behavior of the structure.

Whenever you perform a dynamic analysis of a shear wall structure, and the walls are connected to a floor, you must be careful to use a fine mesh of finite elements for each wall. Each wall should be at least 4 elements high between floors. This will give you at least 3 free joints between them.

Beam Vibration Considerations

When you perform a dynamic analysis of beam structures, such that you are trying to capture the flexural vibrations, (i.e., the beams are vibrating vertically or in the transverse direction), you must make sure that you have at least 3 free joints along the member between the points of support. If you use a distributed load as the mass, you must remember that some of the load will automatically go into the supports and be "lost" to the

dynamic solution. In general, you will get the best results by applying your mass as joint loads to the free joints

Calculate Residual Mass

The mass of the structure that has not been activated by the solved number of periodic modes may still be included in the response spectra analysis results. This is done by checking the **Calc. Residual Mass** box. This checkbox calculates a residual mass mode shape which helps to show where the missing mass in the structure is located. It also includes the response of this missing mass as a static correction to the response spectra results. The acceleration used to calculate this static correction vector is based on largest acceleration from the specified response spectra which occurs between the user entered Cut Off frequency (see below) and the zero period acceleration.

Note:

- The inclusion of Residual Mass does not guarantee that dynamic solution will achieve 100% mass participation . It will normally be close.
- This feature is intended to capture missing RIGID response. When un-solved mode shapes would produce significant periodic response (at frequencies less than 33 Hz, for example), it would be more accurate to include these modes in the analysis than to assume that they are accounted for in the residual mass correction.
- The implementation of the residual mass feature is based on the requirements of ASCE 4 - 1998: Seismic Analysis of Safety-Related Nuclear Structures.

Common Application for Missing Mass Vectors

If you apply your dynamic mass with distributed loads or surface loads on members/plates that are adjacent to supports, remember that the some of the load will go directly into the support and be lost to a traditional dynamic solution. The mass that can actually vibrate freely is your "active mass", as opposed to your "static mass" which includes the mass lost into the supports. If you are having trouble getting 90% mass participation, you should roughly calculate the amount of mass that is being lost into your support to determine if that is the cause of the problem.

Since this mass is directly associated with boundary conditions and cannot be activated by a traditional eigensolution mode, it is referred to as the Residual Rigid Response of the structure. The common solution to account for this response, is to check the **Calc. Residual Mass?** checkbox. This will calculate a "Missing Mass Vector" or "Residual Mass Vector" to account for this residual mass in the dynamic analysis.

Alternatively, one may switch to the [Ritz Vector](#) dynamic solver because Ritz modes inherently include correction for the rigid response

Modal Frequency Results

Access the **Frequencies and Participation** spreadsheet by selecting **Frequencies** from the **Results** Menu.

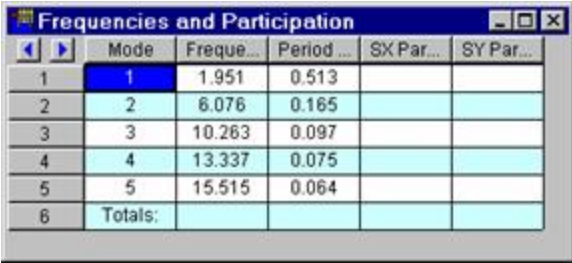

	Mode	Freque...	Period ...	SX Par...	SY Par...
1	1	1.951	0.513		
2	2	6.076	0.165		
3	3	10.263	0.097		
4	4	13.337	0.075		
5	5	15.515	0.064		
6	Totals:				

These are the calculated model frequencies and periods. The period is simply the reciprocal of the frequency. These values will be used along with the mode shapes when a response spectra analysis is performed. The first frequency with a high participation is sometimes referred to as the model's natural or fundamental frequency.

These frequency values, as well as the mode shapes, will be saved and remain valid unless you change the model data, at which time they will be cleared and you need to re-solve the dynamics to get them back.

Also listed on this spreadsheet are the participation factors for each mode for each global direction, along with the total participation. If the participation factors are shown in red (as opposed to black) then the response spectra analysis (RSA) has not been performed for that direction. If the RSA has been done but a particular mode has no participation factor listed, that mode shape is not participating in that direction. This usually is because the mode shape represents movement in a direction orthogonal to the direction of application of the spectra. See [Dynamic Analysis - Response Spectra](#) for more information.

Note:

- If you have not solved an RSA for a given direction then the participation factor will show in red as an indicator. This is not an indication that there is anything wrong with the solution.
- If you are using the **Calc Residual Mass?** checkbox then you will get three "residual" mode shapes that will account for the missing mass vector. For more information on this see the [Residual Rigid Response](#) section.
- At this time residual / missing mass modes are not considered in Time History analysis.

Mode	Frequency ...	Period (Sec)	SX Partic...	SY Par...	SZ Participation
1	1	3.103	.322		68.254
2	2	3.228	.31		
3	3	19.292	.052	68.252	
4	4 (residual)	NA	NA	31.748	
5	5 (residual)	NA	NA	100	
6	6 (residual)	NA	NA		31.746
7	Totals:			100	100

Mode Shape Results

Access the **Mode Shape** spreadsheet by selecting Mode Shapes from the **Results** Menu.

Joint	X	Y	Rotation
1	N1	0	0
2	N2	0.004	0.018
3	N3	0.026	0.038
4	N4	0	0
5	N5	0.006	0.001
6	N6	0.014	0.001
7	N7	0.098	0.058
8	N8	0.089	0.022
9	N9	0.544	0.074
10	N10	1.041	0.086
11	N11	1.481	0.093
12	N12	1.841	0.097
13	N13	2.112	0.098
14	N14	0.01	-0.003
15	N15	0.013	-0.004
16	N16	0	0
17	N17	0.008	-0.001
18	N18	0.012	-0.002
19	N19	0.096	-0.005
20	N20	0.093	-0.017
21	N21	0.546	-0.004
22	N22	1.041	-0.002
23	N23	1.482	0.001

These are the model's mode shapes. Mode shapes have no units and represent only the movement of the nodes relative to each other. The mode shape values can be multiplied or divided by any value and still be valid, so

long as they retain their value relative to each other. To view higher or lower modes you may select them from the drop-down list of modes on the Window Toolbar.

Note

- Keep in mind that the X, Y, and Z mode shapes do not, in and of themselves, represent model deflections. They only represent how the nodes move relative to each other. You could multiply all the values in any mode shape by any constant value and that mode shape would still be valid. Thus, no units are listed for these mode shape values.
- The rotation is in units of radians.

These mode shapes are used with the frequencies to perform a Response Spectra Analysis. The first mode is sometimes referred to as the natural or fundamental mode of the model. The frequency and mode shape values will be saved until you change your model data. When the model is modified, these results are cleared and you will need to re-solve the model to get them back.

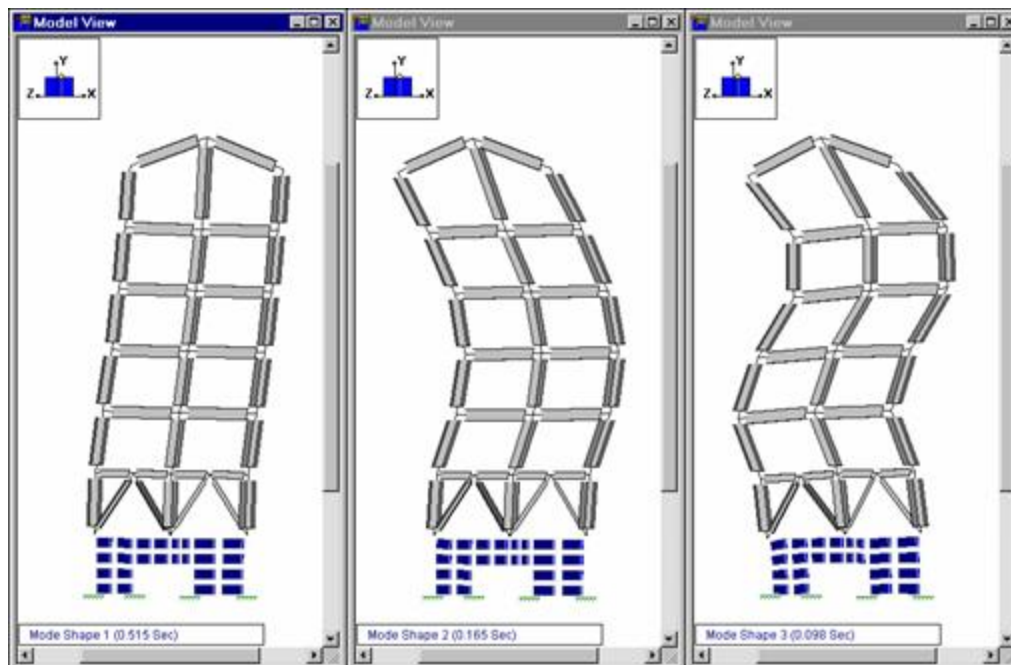

You can plot and animate the mode shape of the model by using the Model Display Options. This allows you to verify the mode shapes that were obtained and highlights local modes making them easy to troubleshoot. See [Model Display Options - Deflections](#) for more information.

Dynamics Troubleshooting – Local Modes

A common problem you may encounter are “localized modes”. These are modes where only a small part of the model is vibrating and the rest of the model is not. Localized modes are not immediately obvious from looking at the frequency or numeric mode shape results, but they can be spotted pretty easily using the mode shape animation feature. Just plot the mode shape and animate it. If only a small part of the model is moving, this is probably a localized mode.

The problem with localized modes is that they can make it difficult to get enough mass participation in the response spectra analysis (RSA), since these local modes don’t usually have much mass associated with them. This will show up if you do an RSA with a substantial number of modes but get very little or no mass participation. This would indicate that the modes being used in the RSA are localized modes.

Quite often, localized modes are due to modeling errors (erroneous boundary conditions, members not attached to plates correctly, etc.). If you have localized modes in your model, always try a Model Merge before you do anything else. See [Model Merge](#) for more information.

Dynamic Analysis - Response Spectra

A Response Spectra Analysis may be performed after the dynamic analysis to obtain forces, stresses and deflections. In general, the response spectra analysis procedure is based on the assumption that the dynamic response of a structural model can be approximated as a summation of the responses of the independent dynamic modes of the model.

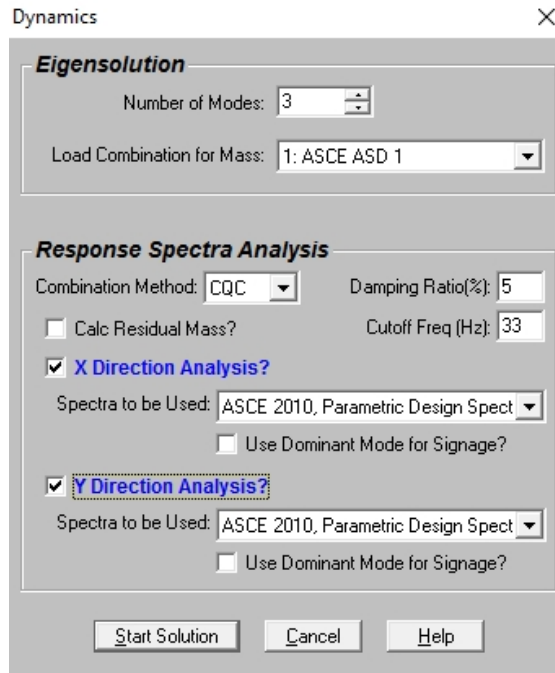

To Perform a Response Spectra Analysis

1. Select **Dynamics (Eigensolution / Response Spectra)** from the **Solve** menu.
2. Set the Eigensolution parameters.
3. Select the desired **Combination Method**. Then use the checkboxes to indicate which directions you want to perform your response spectra analysis.
4. Select the spectra to be used for each direction. Then specify the other parameters.

Note

- For a more thorough explanation of the Eigensolution options refer to [Dynamic Analysis - Eigensolution](#).
- Upon the completion of the solution you are returned to the **Frequencies** and **Participation** spreadsheet and the participation yielded by the RSA is listed. To view model results such as forces/deflections/reactions you will need to create a load combination on the **Load Combination** spreadsheet that includes the spectra results. See below.
- The Dynamic Solver options are located in the Model Settings - Solution tab [Advanced](#) options.

To Include Response Spectra Analysis Results in a Load Combination

1. After running the response spectra analysis go to the desired combination on the **Load Combination** spreadsheet.
2. In the **BLC** column enter "SX" or "SY" as the BLC entry (SX for the X direction RSA results, SY for the Y direction RSA results).
3. To scale the spectral results enter the spectra-scaling factor in the **Factor** column.

Note

- You can include more than one spectra solution in a single load combination. If you do this you can also have RISA-2D combine the multiple RSA results using an SRSS summation. To do this, set the "RSA SRSS" flag for the combination to "+" or "-". Use "+" if you want the summed RSA results (which will be all positive) added to the other loads in the load combination. Use "-" if you want the summed results subtracted.

	Description	Sol...	PD...	SR...	BLC	Factor	BLC	Factor	BLC	Factor	BLC	Factor
1	Dynamic Mass	<input checked="" type="checkbox"/>			DL	1	LL	.25				
2		<input type="checkbox"/>										
3	Unscaled Spectra	<input type="checkbox"/>			SX	1						
4		<input type="checkbox"/>										
5	DL+ SX	<input checked="" type="checkbox"/>			DL	1	SX	.25				
6	DL+LL	<input type="checkbox"/>			DL	1	LL	1				

Response Spectra

The response spectra represent the maximum response of any single degree of freedom (SDOF) system to a dynamic base excitation. The usual application of this method is in seismic (earthquake) analysis. Earthquake time history data is converted into a "response spectrum". With this response spectrum, it is possible to predict the maximum response for any SDOF system. By "any SDOF system", it is meant a SDOF system with any natural frequency. "Maximum response" means the maximum deflections, and thus, the maximum stresses for the system.

Response Spectra Analysis Procedure

In the response spectra analysis procedure, each of the model's modes is considered to be an independent SDOF system. The maximum responses for each mode are calculated independently. These modal responses are then combined to obtain the model's overall response to the applied spectra.

The response spectra method enjoys wide acceptance as an accurate method for predicting the response of any structural model to any arbitrary base excitation, particularly earthquakes. Building codes require a dynamics based procedure for some structures. The response spectra method satisfies this dynamics requirement. The response spectra method is easier, faster and more accurate than the static procedure so there really isn't any reason to use the static procedure.

If you wish to learn more about this method, an excellent reference is **Structural Dynamics, Theory and Computation** by Dr. Mario Paz (1991, Van Nostrand Reinhold).

Frequencies Outside the Spectra

If a response spectra analysis is solved using modal frequency values that fall outside the range of the selected spectra, RISA will extrapolate to obtain spectral values for the out-of-bounds frequency. If the modal frequency is below the smallest defined spectral frequency, a spectral velocity will be used for the modal frequency that will result in a constant Spectra Displacement from the smallest defined spectral frequency value. A constant spectral displacement is used because modes in the "low" frequency range will tend to converge to the maximum ground displacement. If the modal frequency is above the largest defined spectral frequency, a spectral velocity will be used for the modal frequency that will result in a constant Spectra Acceleration from the largest defined spectral frequency value. A constant spectral acceleration is used because modes in the "high" frequency range tend to converge to the maximum ground acceleration (zero period acceleration).

Mass Participation

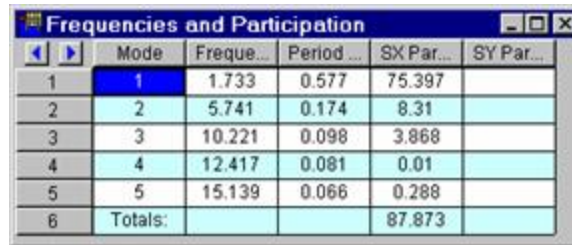

	Mode	Freque...	Period...	SX Par...	SY Par...
1	1	1.733	0.577	75.397	
2	2	5.741	0.174	8.31	
3	3	10.221	0.098	3.868	
4	4	12.417	0.081	0.01	
5	5	15.139	0.066	0.288	
6	Totals:			87.873	

The mass participation factors reported on the **Frequencies Spreadsheet** reflect how much each mode participated in the Response Spectra Analysis solution. Remember that the RSA involves calculating separately the response for each mode to the applied base excitation represented by the spectra. Here is where you can tell which modes are important in which directions. Higher participation factors indicate more important modes. The participation factor itself is the percent of the model's total dynamic mass that is deflecting in the shape described by the particular mode. Thus, the sum of all the participation factors in a given direction can not exceed 100%.

The amount of participation for the mode may also reflect how much the mode moves in the direction of the spectra application. For example, if the 1st mode represents movement in the global Y direction it won't participate much, if at all, if the spectra is applied in the global X direction. You can isolate which modes are important in which directions by examining the mass participation.

Note

- Usually for the RSA to be considered valid, the sum of the modal participation factors must equal or exceed **90%** (e.g. ASCE7-10, Section 12.9.1). If you do an RSA and the total participation is less than 90%, you need to return to the dynamic solution and redo the dynamic analysis with more modes. If you are getting a lot of modes with little or no participation see [Dynamics Troubleshooting – Local Modes](#).
- Models with a large amount of mass lost into boundary conditions may have difficulty achieving 90% mass participation. See [Dynamics Modeling](#) for more information.

Modal Combination Option

There are three choices for combining your modal results: CQC, SRSS, or Gupta. In general you will want to use either CQC or Gupta. For models where you don't expect much rigid response, you should use CQC. For models where the rigid response could be important, you should use Gupta. An example of one type of model where rigid response would be important is the analysis of shear wall structures. The SRSS method is offered in case you need to compare results with the results from some older program that does not offer CQC or Gupta.

CQC stands for "Complete Quadratic Combination". A complete discussion of this method will not be offered here, but if you are interested, a good reference on this method is **Recommended Lateral Force Requirements and Commentary, 1999**, published by SEAOC (Structural Engineers Assoc. of Calif.). In general, the CQC is a superior combination method because it accounts for modal coupling quite well.

The Gupta method is similar to the CQC method in that it also accounts for closely spaced modes. In addition, this method also accounts for modal response that has "rigid content". For structures with rigid elements, the modal responses can have both rigid and periodic content. The rigid content from all modes is summed algebraically and then combined via an SRSS combination with the periodic part which is combined with the CQC method. The Gupta method is fully documented in the reference, **Response Spectrum Method**, by Ajaya Kumar Gupta (Published by CRC Press, Inc., 1992).

The Gupta method defines lower (f_1) and upper (f_2) frequency bounds for modes containing both periodic and rigid content. Modes that are below the lower bound are assumed to be 100% periodic. Modes that are above the upper bound are assumed to be 100% rigid.

Unsigned (All Positive) Results and the Use Dominant Mode For Signage Checkbox

A response spectra analysis involves calculating forces and displacements for each mode individually and then combining these results. The problem is both combination methods offered (SRSS and CQC) use a summation of squares approach that loses the sign. This means that all the results are positive, except reactions, which are all negative as a result of the positive displacements.

Because the RSA results are unsigned you cannot directly add the results to other static loads in you model. One way around this is to treat the RSA results as both positive and negative by manually providing the sign. Using two combinations for each RSA result, one with a positive factor and the other with a negative factor you can capture the maximum deflections, stresses and forces when combining with other loads. See [Load Combinations with RSA Results](#) for an example.

The mass participation may indicate that a model is dominated by a single mode in a direction. You may base the signs for the final combined RSA results on the signs for the RSA for this single dominant mode by checking the box that says "**Use Dominant Mode for Signage?**". When that option is selected then the Mode that that the highest mass participation in that direction will be considered to be the dominant mode.

Limitations on Response Spectra Results

Because of the statistical method used to combine the results, response spectra results can be confusing or misleading to engineers that are not familiar with the process. The confusion is usually associated with the fact any single response spectra result is correct, but that it is not known whether the sign of that result should be positive or negative. This results in a number of limitations that should be considered when using response spectra analysis.

Statics: By default with an RSA solution the results will not obey statics, due to the nature of combining the modes via SRSS, CQC, etc. Thus, if you view the reactions, member forces, etc., the model will not obey statics. If the model has a "dominant" mode in the given direction then the normal path forward would be to select the **Use Dominant Mode for Signage?** checkbox when solving for the dynamic solution.

For additional advice on this topic, please see the RISA Tips & Tricks webpage at risa.com/post/support. Type in Search keywords: **Response Spectra Reactions Satisfy Statics**.

Deflected Shape: By default with an RSA solution the results will not obey statics, due to the nature of combining the modes via SRSS, CQC, etc. Thus, if you view the deflected shape you will see that the deflected shape looks odd. Similar to the "Statics" limitation above, one possible path forward is to use the **Use Dominant Mode for Signage?** checkbox when solving your dynamic solution.

For additional advice on this topic, please see the RISA Tips & Tricks webpage at risa.com/post/support. Type in Search keywords: **Response Spectra Reactions Satisfy Statics**.

Plate and Wall Contours: Plate contours are not presented to the user for RSA load combination unless the **Use Dominant Mode for Signage?** option has been chosen. This is because the results can be misleading due to the "Statics" issue described above.

Wall Panel Reactions: Wall Panel reactions consist of a number of internal nodal reactions that are then summed together across the wall. Since the signs of those reactions are unknown, the reactions for each Wall Panel cannot be correctly calculated. There are two methods of dealing with this issue:

1. The solution described in the "Statics" limitation above
2. Use the [Wall Forces spreadsheet](#) results or Wall Detail Report instead.

Note:

- The Wall Force results (in the detail reports and the Wall Force Results spreadsheet) are calculated correctly because each force is calculated and stored for each mode, which allows a final RSA result to be calculated using the combination method (SRSS, CQC etc) chosen by the user. A future revision to the program may be to calculate and store wall reactions for each mode similar to what is done for the [Wall Forces spreadsheet](#).

Internal Force Summation Tools : Because the Internal force summation tool relies on plate corner forces, these results are not available for wall panels for any load combination which contains RSA results. Internal force summation tools may be used on other portions of the model. However, they will face the same issue that is described under the "Statics" limitation above. For that reason the results are suppressed unless the **Use Dominant Mode for Signage?** option has been chosen.

Other Options

Cut Off Frequency

This is the frequency used by the Gupta method to calculate the upper bound for modes having periodic and rigid content. The "rigid frequency" is defined as "The minimum frequency at which the spectral acceleration becomes approximately equal to the zero period acceleration (ZPA), and remains equal to the ZPA". If nothing is entered in this field, the last (highest) frequency in the selected response spectra will be used.

For seismic response, the typical cutoff frequency would be 33 Hz.

Damping Ratio

The damping ratio entered here is used in conjunction with the CQC and Gupta combination methods. This single entry is used for all the modes included in the RSA, an accepted practice. A value of 5% is generally a good number to use. Typical damping values are:

2% to 5% for welded steel

3% to 5% for concrete

5% to 7% for bolted steel, wood

RSA Scaling Factor (Manual Scaling)

The most difficult part of the entire RSA procedure is normally calculating the scaling factor to be used when including the RSA results in a load combination.

The ASCE 7 uses a particular "shape" for its spectra (See Figure 11.4-1), but the parameters S_{DS} and S_{D1} make it specific to a particular site. However, the ASCE 7 imposes several requirements regarding the minimum design values. ASCE 7-16 Section 12.9.1.4.1 specifies a modification factor, V/V_t (ASCE 7-10 Section 12.9.4.1 specifies a modification factor, $0.85*V/V_t$), that may be used to scale the response spectra results to something less than or equal the base shear calculated using the static procedure (ASCE 7 Sect. 12.8).

The static base shear (V) is calculated using the equations in ASCE 7-16 Sect. 12.8.1

Note that there are limiting values for the static base shear in ASCE 7-16 equations 12.8-3 through 12.8-6.

Therefore, in order to calculate the proper scaling factor, we need to know what the *unscaled* RSA base shear (this is called the Elastic Response Base Shear in the IBC) is, and we also need to calculate the value of "V" (static base shear). The calculation of V isn't particularly difficult because the two values that present the biggest problem in this calculation (T and W) are provided by RISA. To calculate the value of W, simply solve a load combination comprised of the model seismic dead weight. This almost certainly will be the same load combination you used in the **Dynamics** settings for the **Load Combination for Mass**. The vertical reaction total is your "W" value.

The T value is simply the period associated with the dominant mode for the direction of interest. For example, if you're calculating the scaling factor for a Z-direction spectra, determine which mode gives you the highest participation for the Z direction RSA. The period associated with that mode is your T value. Note that there are limiting values for T, see ASCE 7-16 section 12.8.2.

Calculating the unscaled RSA base shear also is very straightforward. Just solve a load combination comprised of only that RSA, with a factor of 1.

Example:

- Assuming we're looking at a Z direction RSA, enter "SZ" in the **BLC** field of the **Load Combinations** spreadsheet and for the **Factor** enter "1". Leave all the other BLC fields blank.
- Solve the load combination and look at the Z direction reaction total. This total value is the unscaled RSA base shear.
- To get the correct scaling factor, solve this equation:

$$\text{Scale Factor} = (V / \text{Unscaled RSA base shear})$$

You would do this calculation to obtain the scaling factors for all the directions of interest (X, Y and/or Z). Unless the model is symmetric the fundamental period for each direction is probably different. Be sure to use the proper value for "T" for the direction being considered.

Note: The ASCE 7 has additional requirements for vertical seismic components. (See ASCE 7-16 section 12.4.2.2).

Automatic Response Spectra Generation

1997 UBC

You may have the 1997 UBC spectra generated automatically by selecting "UBC 97, Parametric Design Spectra" for your RSA. The C_a and C_v seismic coefficients are needed to calculate the values for the UBC '97 spectra. See Figure 16-3 in the UBC for the equations used to build the spectra. See Tables 16-Q and 16-R to obtain the C_a and C_v values. The default values listed are for Seismic Zone 3, Soil Type "Se" (Soft Soil Profile). These values can be edited in the Seismic tab of [Model Settings](#).

2000 IBC

You may have the 2000 IBC spectra generated automatically by selecting "IBC 2000, Parametric Design Spectra" for your RSA. The S_{DS} and S_{D1} seismic coefficients are needed to calculate the values for the IBC 2000 spectra. See Figure 1615.1.4 in the IBC for the equations used to build the spectra. See section 1615.1.3 to obtain the S_{DS} and S_{D1} values. These values can be edited in the Seismic tab of [Model Settings](#).

2005 ASCE

You may have the 2005 ASCE spectra generated automatically by selecting "ASCE 2005, Parametric Design Spectra" for your RSA. The S_{DS} , S_{D1} , and TL seismic coefficients are needed to calculate the values for the ASCE 2005 spectra. See Figure 11.4-1 in ASCE-7 2005 for the equations used to build the spectra. See section 11.4.4 to obtain the S_{DS} and S_{D1} values and Figures 22-15 thru 22-20 for the TL value. These values can be edited in the Seismic tab of [Model Settings](#).

2010 ASCE

You may have the 2010 ASCE spectra generated automatically by selecting "ASCE 2010, Parametric Design Spectra" for your RSA. The S_{DS} , S_{D1} , and TL seismic coefficients are needed to calculate the values for the ASCE 2010 spectra. See Figure 11.4-1 in ASCE-7 2010 for the equations used to build the spectra. See section 11.4.4 to obtain the S_{DS} and S_{D1} values and Figures 22-12 thru 22-16 for the TL value. These values can be edited in the Seismic tab of [Model Settings](#).

2016 ASCE

You may have the 2016 ASCE spectra generated automatically by selecting "ASCE 2016, Parametric Design Spectra" for your RSA. The S_{DS} , S_{D1} , and TL seismic coefficients are needed to calculate the values for the ASCE 2016 spectra. See Figure 11.4-1 in ASCE-7 2016 for the equations used to build the spectra. See section 11.4.5 to obtain the S_{DS} and S_{D1} values and Figures 22-14 thru 22-17 for the TL value. These values can be edited in the Seismic tab of [Model Settings](#).

2005 NBC

You may have the 2005 NBC spectra generated automatically by selecting "NBC 2005 Parametric Design Spectra" for your RSA. The Site Class and the S_a values are needed to calculate the values for the NBC 2005 spectra. Please see section 4.1.8.4(7) to obtain the S_a values and Table 4.1.8.4(A) for the Site Class. Please see section 4.1.8.4(7) for the equations used to build the spectra. These values can be edited in the **Seismic** tab of [Model Settings](#).

2010 NBC

You may have the 2010 NBC spectra generated automatically by selecting "NBC 2010 Parametric Design Spectra" for your RSA. The Site Class and the S_a values are needed to calculate the values for the NBC 2010 spectra. Please see section 4.1.8.4(7) to obtain the S_a values and Table 4.1.8.4(A) for the Site Class. Please see section 4.1.8.4(7) for the equations used to build the spectra. These values can be edited in the **Seismic** tab of [Model Settings](#).

2015 NBC

You may have the 2015 NBC spectra generated automatically by selecting "NBC 2015 Parametric Design Spectra" for your RSA. The Site Class and the S_a values are needed to calculate the values for the NBC 2015 spectra. Please see section 4.1.8.4(7) to obtain the S_a values and Table 4.1.8.4(A) for the Site Class. Please see section 4.1.8.4(7) for the equations used to build the spectra. These values can be edited in the **Seismic** tab of [Model Settings](#).

Adding and Editing Spectra

You may add your own spectra to the database and edit and delete them once they are created. You can add/edit spectra data pairs in any configuration by choosing between Frequency or Period and between the three spectral values. You may also choose to convert the configuration during editing. At least two data points must be defined. Log interpolation is used to calculate spectra values that fall between entered points. Make sure that all of the modal frequencies in your model are included within your spectra.

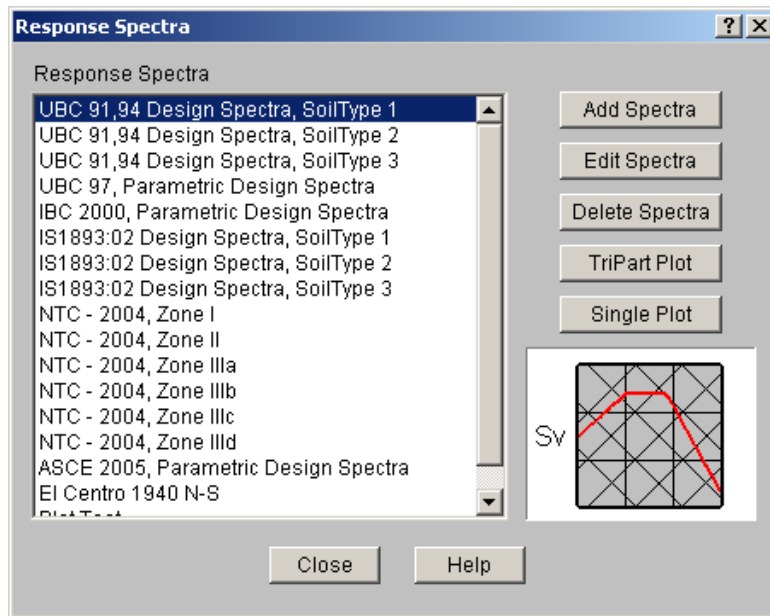

To Add or Edit a Spectra

Note

- Zero values are not allowed in the data.

Tripartite Response Spectra Plot

This plot is a convenient logarithmic representation of all the values of interest in the response spectra definition.

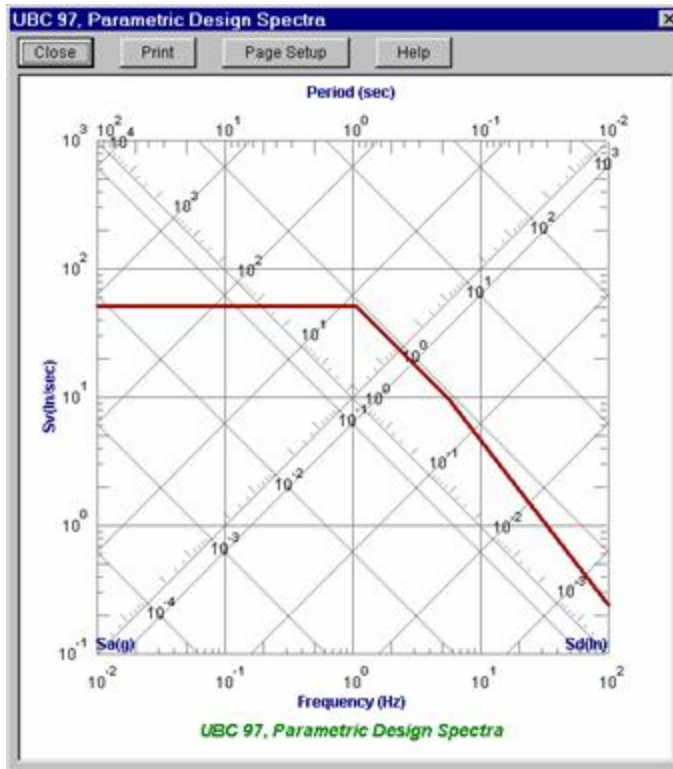

These values are as follows:

Frequency (f)

Period (T)

Pseudo Velocity (Sv)

Pseudo Acceleration (Sa)

Pseudo Displacement (Sd)

The relationships between these values (for the undamped case) is as follows:

$$T = 1. / f$$

$$Sv = Sd * 2\pi f = Sa / 2\pi f$$

For the tripartite plot, the frequency values are plotted along the bottom with the reciprocal period values displayed along the top. The ordinate axis plots the Sv values (labeled on the left side) and the diagonal axes plot the Sa (lower left to upper right) and Sd (upper left to lower right) values.

The spectra data itself is represented with the thick red line. Therefore, to determine the Sv, Sa or Sd value for a particular frequency or period, locate the desired period or frequency value along the abscissa axis and locate the corresponding point on the spectra line. Use this point to read off the Sv, Sa and Sd values from their respective axes. Remember, all the axes are logarithmic!

Single Spectra Plot

This plot is a Response spectra representation that is given in the building codes. The vertical axis can plot the spectra using Pseudo-Acceleration, Pseudo-Velocity, or Pseudo Displacement on a vertical or logarithmic scale. The horizontal axis will plot the Period or Frequency using a Linear or Logarithmic scale.

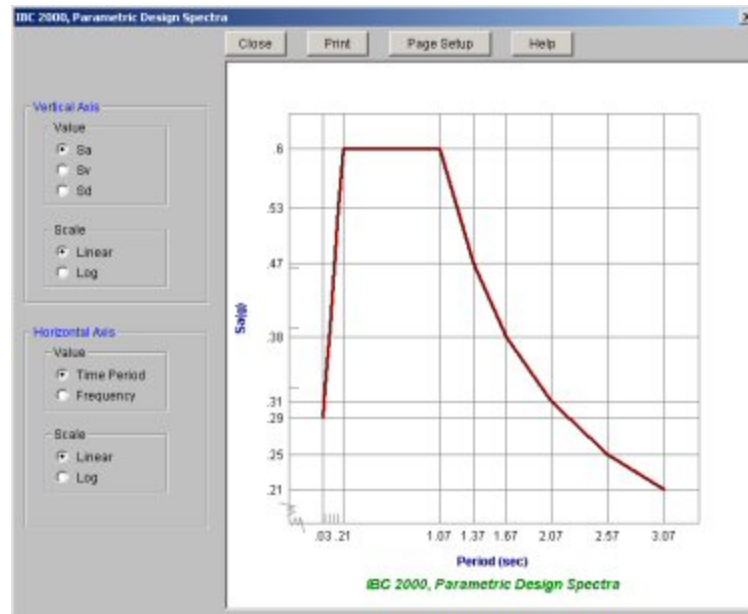

These values are as follows:

Frequency (f)

Period (T)

Pseudo Velocity (Sv)

Pseudo Acceleration (Sa)

Pseudo Displacement (Sd)

The relationships between these values (for the undamped case) is as follows:

$$T = 1. / f$$

$$S_v = S_d * 2\pi f = S_a / 2\pi$$

The spectra data itself is represented with the thick red line. Therefore, to determine the S_v , S_a or S_d value for a particular frequency or period, locate the desired period or frequency value along the horizontal axis and locate the corresponding point on the spectra line. Use this point to read off the S_v , S_a and S_d values from their vertical axis.

File Operations

You may create, save, and recall files from the **File Menu** or from the toolbar buttons just beneath the menu on the **RISA Toolbar**. Importing and exporting other file types may also be accomplished from the **File Menu**.

Starting Off

When you open the program or start a new model, you are presented with the following options: Draw Members, Draw Plates, Generate a Model, and Go to the File Open Dialog

The first group of options is to help you to create a new model by drawing members or plates or by generating with a template. The second group of options helps you open existing files by showing you the most recent files or letting you find the model you want in the Open File Dialog.

Creating a New Model

- On the RISA toolbar click the **New Model**  button. You will be prompted to 'Save' if you have made any changes to the current model that have not yet been saved.



Opening an Existing Model

1. On the RISA toolbar click the **Open File**  button.
2. In the **Look In** field click the drive, folder, or location that contains the file.
3. In the folder list, double-click the folders until you open the folder that contains the file you want.
4. Double-click the file you want to open.

Tip

- To open a model you have used recently, click the **File Menu** and select from the file names at the bottom of the menu.

Saving a New Untitled Model

1. On the RISA toolbar click the **Save Model**  button.
2. To save the model in a different folder, click a different drive in the **Save in** field, or double-click a different folder in the folder list. To save the model in a new folder click the **Create New Folder**  button.
3. In the **File name** field type a name for the document. You can use long, descriptive filenames if you want.
4. Click **Save**.

Saving an Existing Model

1. On the RISA toolbar click the **Save Model**  button.

Appending Models

You may append other models into the current model by choosing **Append** from the **File** menu. This lets you have a library of common model parts that you can use later or to divide projects into smaller parts and later combine them. This feature does not allow you to combine two unopened models. You must first open one of the models, and then append the second model into the first model. If you want to have an unmodified copy of the first model, you will need to save the new combined model under a new file name.

You can only append files from version 6.0 and newer ,files. If you've got an older file that you want to append, you will first need to open that file by itself and save it.

Your appended model will be placed in the current model using the original coordinate data that was in the appended model. The appended model is NOT moved to the origin of the current model. So, if the appended

model had an X coordinate of 9.0 for all joints, then it will be placed at a X coordinate of 9.0 in the current model.

The **Drawing Toolbar** will already be opened in the model view so that you can easily adjust the placement of your appended model using the graphics editing tools. The entire original model will automatically be unselected and your appended model will be selected. If you're going to make several adjustments to the position of your appended model, you should probably click the **Lock Unselected**  button. Then you can use the graphical editing tools to put your appended model where you want it in the current model.

You can use the labels for the Joints, Members, and Plates to help identify the parts as you append them into your current model. Use the **Relabel Joints**, **Relabel Members**, and **Relabel Plates** options on the **Tools** menu to make the label prefix unique for each of your model parts before you append them.

Note

- The appended model properties will be set to the current model properties in cases where there is a conflict. For example, if both models use the same section set label, the current model properties will be used to define the section set. The same is true for material properties, moving loads, and so on.
- Loads remain in the same basic load case. For example if the appended model has loads in BLC 3 these loads will be placed in BLC 3 of the current model.
- tnxTower model files may also be appended together.

For additional advice on this topic, please see the RISA Tips & Tricks webpage at risa.com/post/support. Type in Search keywords: **Append**.

Importing and Exporting Files

You may import DXF drawing files and BIM Exchange files. See [DXF Files](#) and [Appendix E](#) for more on these file types.

To Import Other File Types

1. On the **File** menu click **Import**.
2. Choose the **File Type**.
3. Select the file you wish to import.
4. Choose from the options associated with the type of file.
5. Perform a Model Merge. See [Model Merge](#) for more information.

To Export Other File Types

1. On the **File** menu click **Export**.
2. Choose the **File Type** in the drop down list.
3. Select the file you wish to export.
4. Choose from the options associated with the type of file.

Automatic Backup

RISA-2D provides an automatic backup system for systematically backing up your models. The purpose of this is to provide a means for you to recover your data in the event RISA-2D or your computer closes unexpectedly. As you work within RISA-2D your model is saved with a "_backup" suffix to a model backup folder. By default, this automatic save operation takes place every 5 minutes, but you can alter the timing and location with the [Application Settings](#) on the **Tools Menu**. Backups for the last 100 models that you worked on are saved, although you can control how many models are backed up with the **Application Settings** option on the **Tools Menu**.

If RISA-2D does close unexpectedly, the next time you start the program the following message will appear:

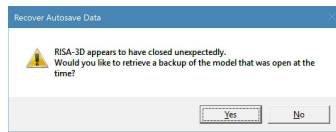

If this message appears and you answer "Yes", you will be directed to the backup folder which contains all of the model backups. If you answer "No" then the program will proceed with opening a new model, or the model that you double-clicked on to open the program.

Generation

You may automatically generate regular structures or portions of structures to start a new model or add to an existing model.

Access the Generation types by clicking  on the RISA toolbar. You will see the following options, which require you to specify basic parameters to generate structures with beam elements, plates, or a combination of both.

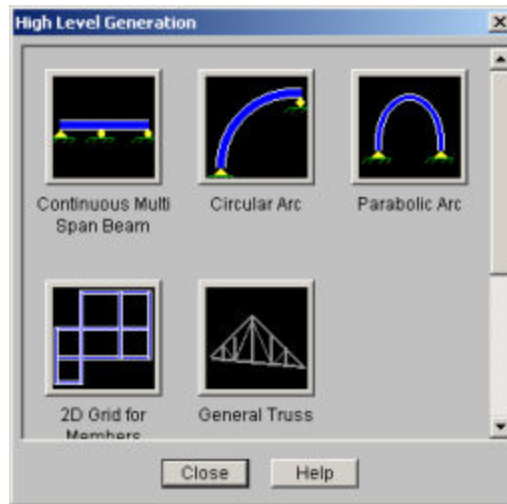

Note

- To generate items that are not coincident to the global axes first define them in the global directions and then rotate them into the correct position.
- The plate and member generation is optional for each generation.
- The generations are powerful but as a result of this some also have many options. Remember that any generation may be undone by clicking **Undo** so don't hesitate to try something just to see what it does.

Continuous Beam Generation

The Continuous Beam generation will produce a complete model of various types of beams. You can simultaneously generate the beam geometry, section properties, boundary conditions, uniform distributed loads, and unbraced lengths for code checking.

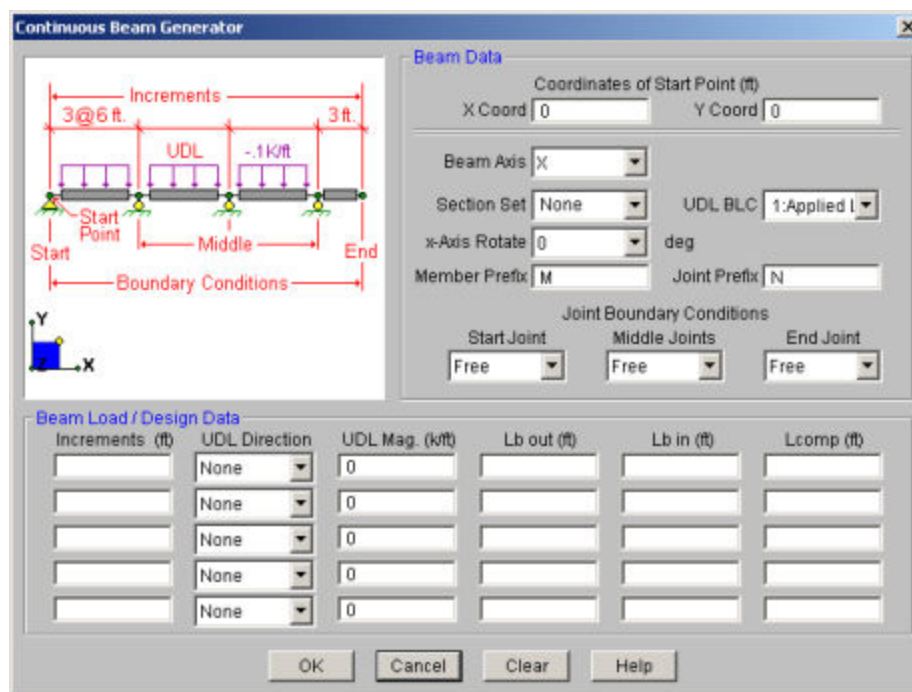

Specify the start point for the beam generation. This defines the first point for beam and is also the “Start Joint” for any boundary conditions.

Choose which axis you want to be the longitudinal axis of the beam. (I.e., the beam will run parallel to this axis).

To generate members for the beam, you must select a valid section set. This section set will be used for all parts of the beam. If you don’t select a section set, you will just get a sequence of joints.

If you are generating loads, select a Basic Load Case for any distributed loads. All the loads will put into this basic load case.

For any generated members, you may assign a “x-axis rotate angle”, and member label prefix. The “x-axis rotate” may be used to rotate the local axes to a desired orientation.

You may optionally enter a Joint label prefix which will be used for all the joints generated as part of the beam. This is useful if you want a way to track individual parts of your model by looking at joint prefixes.

You can also generate boundary conditions for the joints along the continuous beam. You can specify different boundary conditions for the Start Joint, all the middle joints, and the End Joint. You choices for the boundary conditions are Free, Roller, Pinned, and Fixed. These are just like the regular boundary conditions that you would assign elsewhere in the program. The “Free” option is useful for the first or last joint if you want a cantilever overhang. The “Roller” option will only restrain the vertical translation. The “Pinned” option will restrain all the translations. The “Fixed” option restrains all the translations and rotations. See [Boundary Conditions](#) for more information.

Special symbols may be used to define multiple equal increments:

The “@” entry may be used to specify multiple, equally spaced, grid increments. For example, if you wanted 7 increments at 10 units each, you would type “7@10”.

The “/” entry subdivides a larger increment into smaller equal increments. For example, the entry “12/4” would create 4 increments of 3 units each.

Use commas (“,”) to enter multiple increments in a single edit field. For example, if you wanted to define increments of 3, 4, 7 and 2 units, you could enter each increment in a separate field, or you could enter “3,4,7,2” in a single field to get the same result.

With each increment, you can also generate distributed loads by selecting a valid distributed load category and direction, and assigning a load magnitude.

Lastly, you can also generate unbraced lengths for your increments. These are used by the code checking to calculate axial and flexural stresses or strengths depending on what design code you are using. See [Hot Rolled Steel Design](#) and [Wood / Timber Design](#) for information on member design.

Circular Arc Generation

The circular arc generation enables you to generate a full circle or partial arc comprised of beam elements.

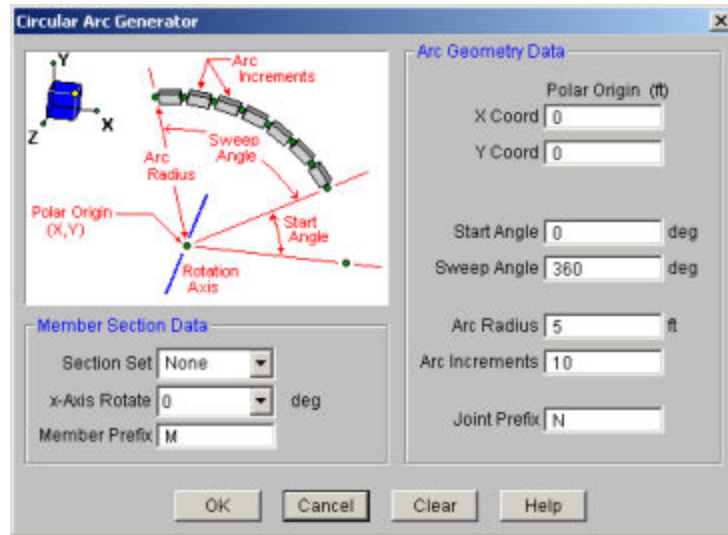

The polar origin is the center point of the arc. You may generate an arc the full 360 degrees around the axis of rotation or generate a partial arc by specifying the start and sweep angles.

The arc radius is the length from the polar origin to the arc. The arc increment determines how many piecewise straight segments are used to model the arc.

To generate members for the arc, you must select a valid section set. This section set will be used for all parts of the arc. If you don't select a section set, you will generate an arc of joints without members. The "x-axis rotate" may be used to rotate the local axes to a desired orientation, however you may find that a K-joint better serves this purpose in some instances. You may also have unique labels assigned to the generated members, by entering a start label.

For additional advice on this topic, and how to use the Circular Arc to model a Dome structure, please see the RISA Tips & Tricks website: www.risa.com/post/support. Type in Search keywords: **3D Dome**.

Parabolic Arc Generation

The Parabolic Arc generation is used to make arcs that are parabolic. The arc model will be comprised of joints and optional members.

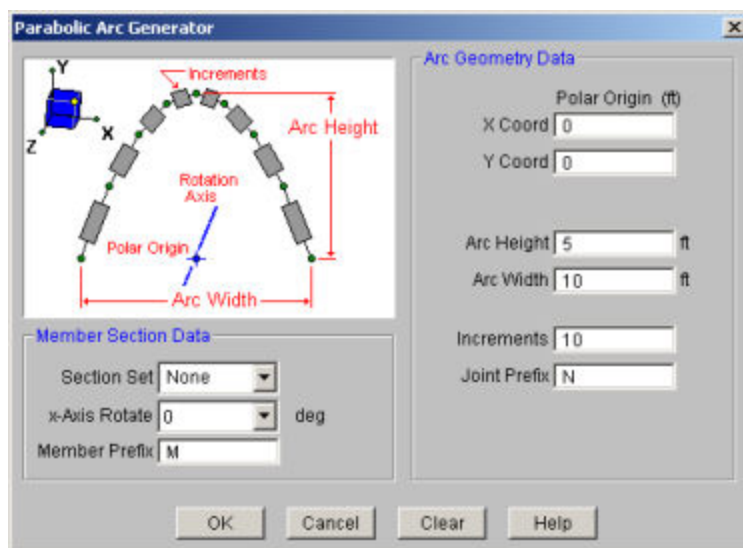

Specify the polar origin about which the arc will be generated.

You must enter the arc height and the arc width.

Enter the number of arc increments to be used to model the arc. The more increments used, the more closely the final geometry will follow the desired parabola. The minimum increments are two, which will give you a triangular shape.

You may optionally enter a Joint Label prefix that will be used for all the joints generated as part of the arc. This is useful if you want a way to track individual parts of your model by looking at joint prefixes.

To generate members for the arc, you must select a valid section set. This section set will be used for all parts of the arc. If you don't select a section set, you will generate an arc of joints without members. The "x-axis rotate" may be used to rotate the local axes to a desired orientation. You may also have unique labels assigned to the generated members, by entering a start label.

Grid Member Generation

This generation enables you to generate 2D (or even 1D (line) grids) of joints and members with equal or unequal grid increments.

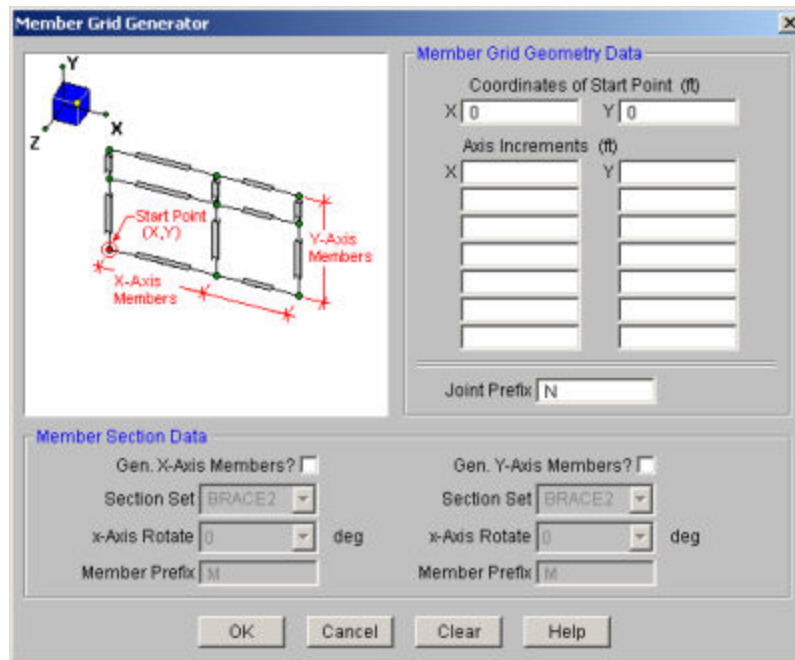

Define the X and Y coordinates of the starting point and the increments for spacing in both global directions. If you don't define any increments parallel to a particular axis no grids will be generated in that direction. Negative increments are OK. Joints are created at all the grid intersection points.

Special symbols may be used to define multiple equal increments:

The "@" entry may be used to specify multiple, equally spaced, grid increments. For example, if you wanted 7 increments at 10 units each, you would type "7@10".

The "/" entry subdivides a larger increment into smaller equal increments. For example, the entry "12/4" would create 4 increments of 3 units each.

Use commas (",") to enter multiple increments in a single edit field. For example, if you wanted to define increments of 3, 4, 7 and 2 units, you could enter each increment in a separate field, or you could enter "3,4,7,2" in a single field to get the same result.

You may create members in the global directions between the grid points. You may use different section sets in the three global directions. For example if the Y-axis is the vertical axis you can specify a column shape for the Y-axis members and different or similar beam shapes for the X-axis members.

You may have unique labels assigned to the generated members, by entering a start label, and you may also use different labels for the three member directions.

General Truss Generation

The general Truss Builder generation is used to make various trusses and various forms of truss joints. The truss will be comprised of joints and an optional top chord, bottom chord, vertical strut member, and diagonal brace member. You may make the truss out of any material type (General, Hot Rolled, Wood, et cetera) by choosing your Material from the radio buttons provided.

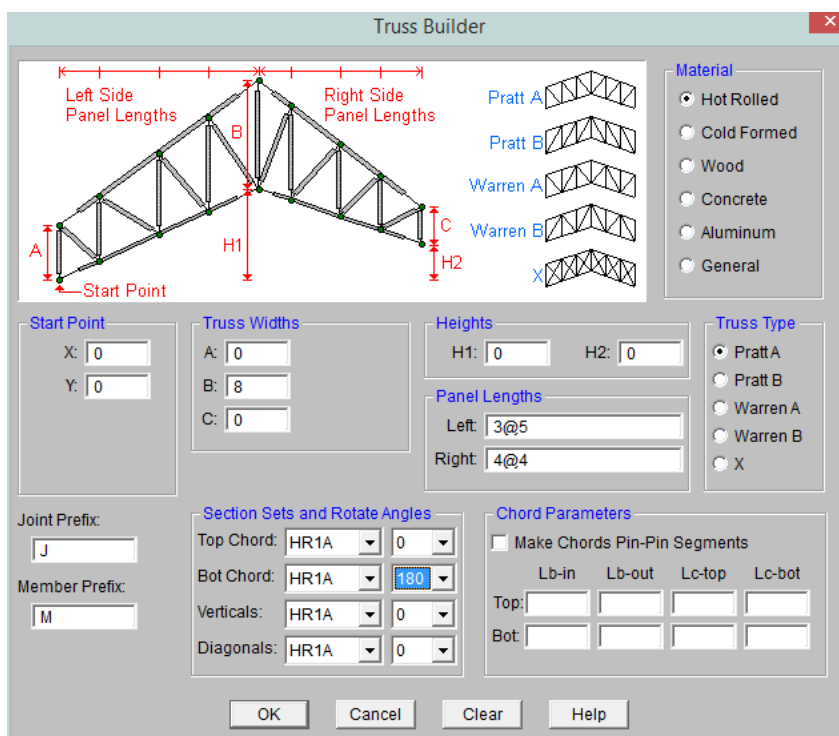

The **start point** for the truss generation defines the first point of the bottom chord.

You must enter the **truss height** and the **panel lengths** to the left and right of truss "peak". You may use symbols such as "@", "/" and "," when entering the panel lengths.

The "@" entry may be used to specify multiple, equally spaced panels. For example, if you wanted 7 panels at 10 units each, you would type "7@10" in the panel lengths as shown in the image below.



The "/" entry subdivides a larger panel length into smaller, equal increments. For example, the entry "12/4" would create 4 panels of 3 units each as shown in the image above.

Use commas (",") to enter multiple, varied panel lengths. For example, if you wanted to define panels of 3, 4, and 7 units, you could enter "3,4,7" in the increment field as shown in the image above.

The **Truss Type** selects what configuration the truss will use. The **Truss Plane** defines the plane of the truss.

You can vary the elevation of the bottom chord by setting the Heights (**H1** and **H2**). You may adjust the elevation of the top chords by adjusting the truss Widths (**A**, **B**, **C**).

You may optionally enter a Joint label prefix that will be used for all the joints generated as part of the truss. Similarly, you may enter a Member label prefix that will be used for all the members generated as part of the truss. This is useful if you want a way to track individual parts of your model by looking at Member or Joint prefixes.

You may optionally create members for the bottom chord, top chord, vertical strut, and diagonal brace. For each one of these members you must assign a valid independent section set, and "x-axis rotate angle". Note that you must mark the checkbox for a member type before you can set any of the values to indicate that you want generation performed for that member type.

The “x-axis rotate” may be used to rotate the local axes to a desired orientation.

Geodesic Dome Generator

Cylinder Generation

Cone Generation

Grid Plate Generation

The Grid Plate generation is used to make 2D grids comprised of joints and optional plates.

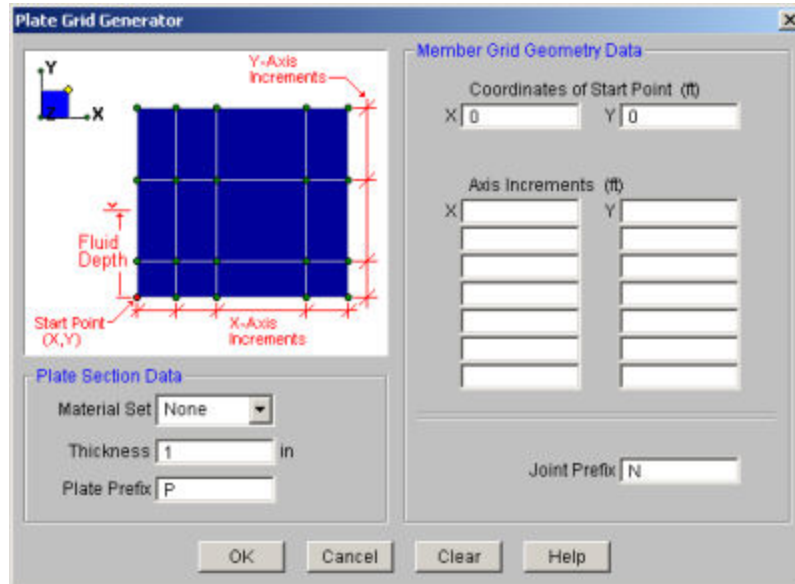

Simply define a starting point (enter the X and Y coordinates of that point) and then define the increments for grid spacing in both global directions. Negative increments are OK. Joints are created at all the grid intersection points.

Special symbols may be used to define multiple equal increments:

The “@” entry may be used to specify multiple, equally spaced, grid increments. For example, if you wanted 7 increments at 10 units each, you would type “7@10”.

The “/” entry subdivides a larger increment into smaller equal increments. For example, the entry “12/4” would create 4 increments of 3 units each.

Use commas (“,”) to enter multiple increments in a single edit field. For example, if you wanted to define increments of 3, 4, 7 and 2 units, you could enter each increment in a separate field, or you could enter “3,4,7,2” in a single field to get the same result.

You may also have plates created between the grid points and have unique labels assigned to the generated plates, by entering a start label.

A valid material set must be selected in order for plates to be generated. The default is “None”, so you will need to select a material from the list of currently defined material labels to generate your plates.

A hydrostatic load may also be generated along the grid of plates as you generate it. The hydrostatic load will be generated using a series of uniform surface loads on your plate elements. If the fluid depth is constant along the grid, you will just get uniform loads on your plates. If the fluid depth varies along the grid, you will get a series of uniform surface loads that increase in a “stair step” fashion, as you move down the fluid depth. The

value of each uniform surface load is equal to the value of the actual hydrostatic load at the mid-point of the plate. The load direction will be perpendicular to the plates.

The fluid depth is measured in the positive vertical direction from the starting point for the plate grid.

The default fluid density is for water, but any density can be entered. The Fluid Load BLC provides a drop down list of all the Basic Load Cases. If you've defined in any descriptions for your BLC's, these will be shown in the drop down list. The surface loads generated will be placed in the selected Basic Load Case.

Circular Disk Generation

The Circular Disk generation enables you to generate a circular disk comprised of plate elements.

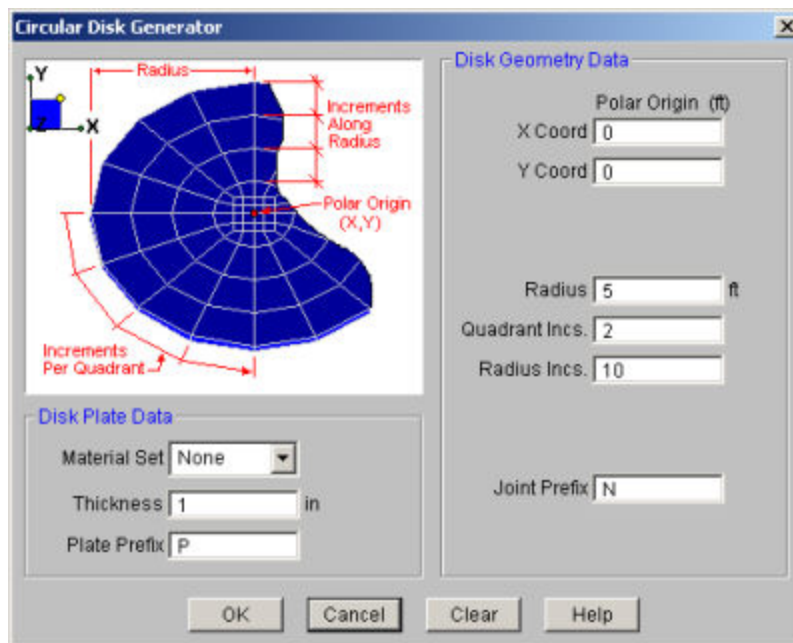

Specify the polar origin as the point about which the grid rotates. The grid is generated the full 360 degrees around the axis of rotation.

The radius is total length from the polar origin to the outer edge of the grid. The quadrant increment determines how many piecewise straight segments are used to model the sweep for each quadrant of the arc. Note this entry must be a multiple of 2 (2,4,6, etc.) due to modeling constraints at the center of the disk. The radius increment specifies how many "rings" to use to create the grid.

You must enter a material set and thickness to have plates defined. Only quadrilateral plates are generated. You may also specify labels assigned to the plates.

Circular Radius Generation

The circular radius generation enables you to generate a full or partial circular grid comprised of joints and optional members and plates.

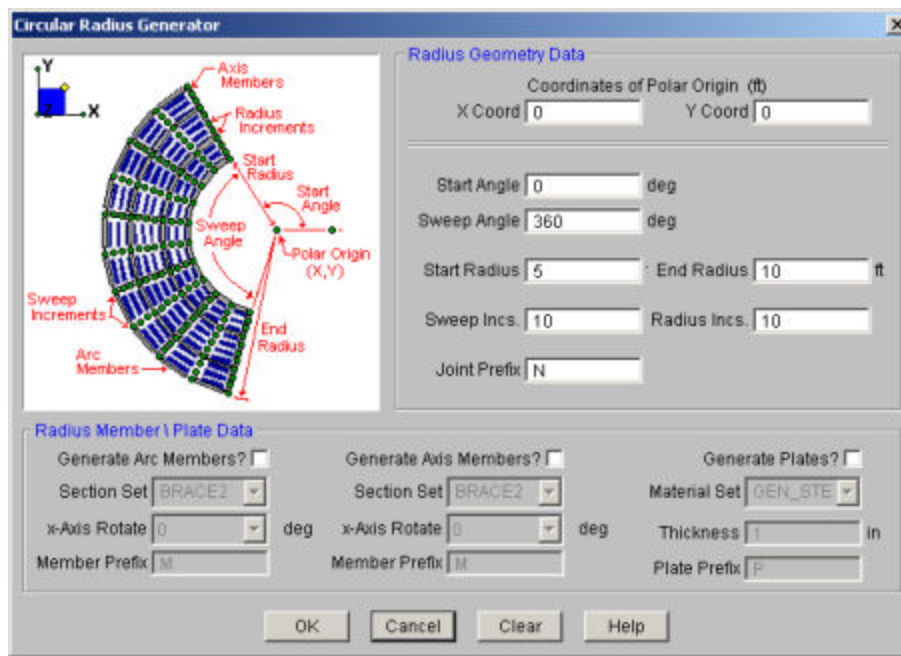

The polar origin is the center point of the disk. You may generate a grid the full 360 degrees around the axis of rotation or generate a partial grid by specifying the start and sweep angles.

The start radius is the radius of the “hole” in the center. This distance must be greater than zero and less than the end radius entry. The end radius is total length from the polar origin out to the edge of the grid. The number of increments along the radius tells RISA-2D how many “rings” to use to create the grid. The sweep increment determines how many piecewise straight segments are used to model the arc.

There are entries for a section set for both the arc members and the radius members so these two sets of members can be different sizes. To generate these members you must select a valid section set. If you don’t select a section set, you won’t generate these members. You may also have unique labels assigned to the generated members by entering a start label.

Finally, you enter a material set and thickness to have plates defined. Only quadrilateral plates are generated. You may also have unique labels assigned to the generated plates by entering a start label.

(Global) Model Settings

The **Model Settings** may be accessed through the menu or toolbar buttons highlighted below.

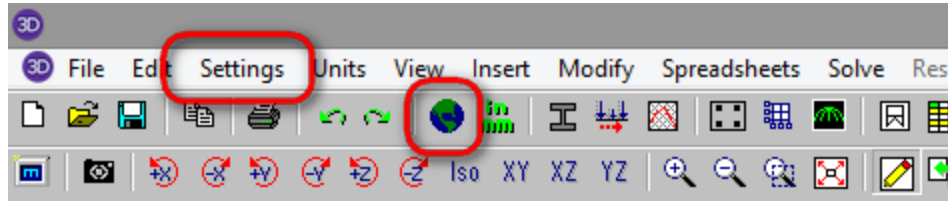

The Model Settings are settings specific to the model which is currently open. The information stored here is retained with the model, and will be retained even if the model is opened on a different computer.

You may save any of the settings in the Model Settings as the default setting, such that new models you create will begin with the settings that you saved as Defaults. To do this, simply enter the information that you want to save and click the **Save as Defaults** button.

Description

 A screenshot of the 'Global Parameters' dialog box. The 'Description' tab is selected. The dialog contains several text input fields: 'Model Title' (filled with 'Reactor Support 803B'), 'Company' (filled with 'My Engineering Firm'), 'Designer' (filled with 'M. Brown'), 'Job Number' (filled with '2014-1234'), and 'Checked By' (empty). Below these is a 'Notes' text area containing two lines of text: 'This model represents the 50% DD phase of the support structure for Reaction 803B.' and 'Some braces have been removed from this model to represent a maintenance access condition.' At the bottom left is a 'Save as Defaults' button. At the bottom right are 'OK', 'Cancel', 'Apply', and 'Help' buttons.

The entries under the **Description** tab are used to enter descriptive information such as a title for the particular model being defined, the name of the designer and a job number. The title may then be printed at the top of each sheet of the output, and on the graphic printouts of the model. Note that for any of these tabs, you can click on **Save as Defaults** and then your settings will be saved the next time you open the program.

The **Checked By** field is intended for the model reviewer to initial upon completion of a model review. Their initials will then be printed on each sheet of the output.

The **Notes** field is intended for information about the model that may be useful for the engineer or reviewer to refer to.

Solution

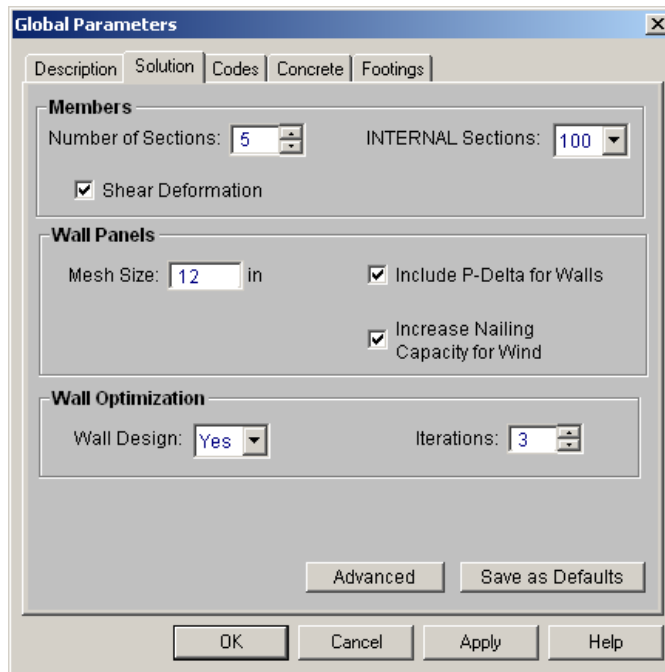

The entries under the **Solution** tab are used to control settings that affect the general solution of the model.

Members

Number of Sections controls how many places you receive **reported** member force, stress, torsion, and deflection results. This only affects the amount of data displayed in the results spreadsheets, and has no effect on the solution of the model or the code checks. See [Printing](#) and [Member Results](#) for more information.

Number of Internal Sections controls how many places along each member the software calculates and stores results such as deflections and code checks. The member force diagrams displayed in the model view and the detail plot are also drawn from these results. Increasing this value means that the program will make more "cuts" along the beam's length, which means it is more likely to hit the theoretical maximum and minimum values for code checks.

Note:

- Number of Sections cannot exceed 20. Also, Number of Internal Sections cannot be less than twice the Number of Sections. If unacceptable values are entered for either of these fields the program will automatically reset them to acceptable values.

Check the **Shear Deformation** box if shear deformation considerations are to be included in the model solution. See [Member Shear Deformations](#) for more information.

Wall Panels

The **Mesh Size** is the base mesh size that is used when wall panels solved. If there is a constraint smaller than this mesh size, the mesh will be refined to accommodate this constraint. You can see the mesh size graphically on the wall panels when you solve your model.

Note: The mesh size is also used for plate sub-mesh for RISAFloor Concrete floor Semi-Rigid diaphragms.

Include P-Delta for Walls is used to enable [P-Delta](#) analysis for wall panels. Even if this box is checked the P-Delta analysis will only be performed on load combinations which have P-Delta enabled.

The **Increase Nailing Capacity for Wind** option will automatically increase the shear capacity of wood wall and diaphragm panels by 1.4 for all load combinations that contain wind loads. Load combinations that have both wind and seismic loads acting simultaneously will not receive this increase.

Wall Optimization

The **Wall Design** option defines whether you want to automatically iterate the solution for masonry and wood walls.

The **Iterations** option defines how many automatic iterations will occur.

Note:

- This automatic iteration procedure will only happen for Batch or Envelope solutions. This is because we do not want to update your wall panel thicknesses if you are only solving a DL combination. In that case the program would then downsize your panel unnecessarily.
- For more information on masonry wall optimization see the [Masonry Wall - Design](#) topic.
- For more information on wood wall optimization see the [Wood Wall - Design](#) topic.
- Concrete wall design will be done automatically and the selections here will not affect this design. This is because concrete wall reinforcement changes will have very little effect on the stiffness of the walls.
- The program will stop the iteration procedure if the results from the previous solution match the results from the current solution.

Advanced

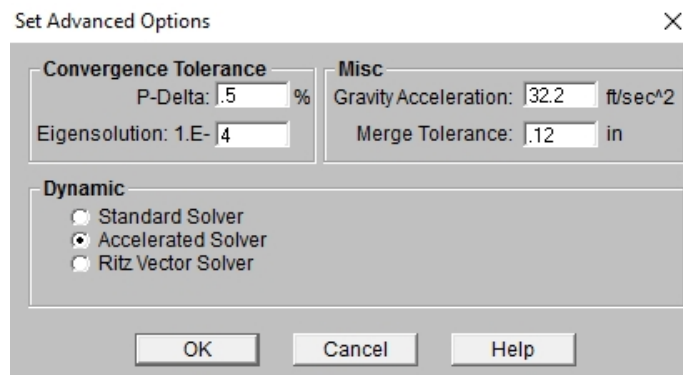

The **P-Delta Tolerance** is used to adjust the tolerance used to determine convergence of the P-Delta analysis. Be sure to enter this value as a *percentage*! The default for this is ½ of 1 percent (.5%). See [P-Delta Analysis](#) to learn more about this.

The **Convergence Tolerance** is used to set how close a subsequent solution must be to the previous solution for a mode to be considered converged. See [Dynamic Analysis](#) for more information.

The **Gravity Acceleration** is used to convert loads into masses for the purpose of a dynamic analysis.

The **Merge Tolerance** is used as the maximum distance 2 joints can be apart and still be merged together. It is also used when scanning for crossing members and for unattached joints along the spans of members.

The **Dynamics Solver** options allow you to choose between the Standard Solver, the Accelerated Solver and a Ritz Vector solution. Refer to the [Solution](#) topic for a more details.

- The accelerated solver uses an accelerated sub-space iteration with a Lanczos starting vector. The accelerated solver is the default and should produce solution in a fraction of the time that the standard solver would take to produce them.
- The Standard Solver uses a simple sub-space iteration to solve for the natural frequencies. This solver has been used for years and the accuracy of the results is very well established. It has been included only for comparative / verification purposes.

- The Ritz Vector solution does not solve for true mode shapes and natural frequencies. However, it is generally the best choice when running a response spectra analysis. The use of Load Dependent Ritz vectors provides a more accurate response spectra analysis for the same number of modes.

Codes

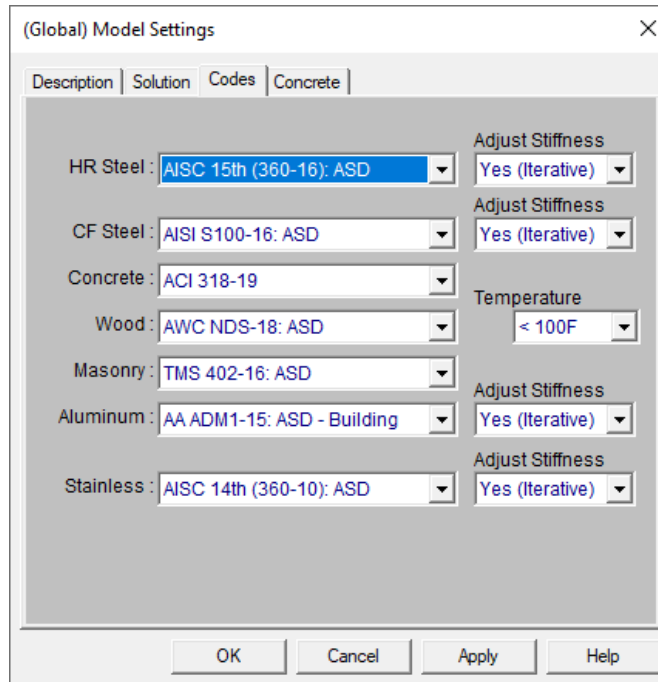

The settings under the **Codes** tab control which design code is used for code checks for each material type.

The **HR Steel** entry indicates which code is to be used for the design of hot rolled steel. For more information see [Hot Rolled Steel Design](#).

Note:

- If the AISC 360 code is selected (either ASD or LRFD), the **Adjust Stiffness** menu will appear. The options in this menu control the stiffness reduction provisions listed in the code. See [Hot Rolled Steel - Design](#) for more information on how the reduction is calculated and applied.
- If the EN 1993-1-1:2005 (Eurocode) is selected, the **National Annex** menu will appear. If you select "None" the design will be performed per the generic Eurocode specifications. If you select a National Annex from the list then the provisions relating to that specific National Annex will also be considered in the design. Where the National Annex and the generic Eurocode differ, the National Annex provisions are used. See the [Hot Rolled Steel - Design](#) topic for more information on the differences in design.

The **CF Steel** entry indicates which steel code is to be used for the design of cold formed steel. For more information see [Cold Formed Steel Design](#).

The **Wood** entry indicates which wood code is to be used for the design of wood, including wood walls and structural composite lumber. For more information see [Wood Design](#).

Note:

- The temperature menu is used to calculate the temperature factor (C_t) for the NDS code design. This factor is used in the design of wood members for all editions of the AF&PA code. See NDS-2012, Section

2.3.3 for more information.

- This selection is ignored for the CSA 086 code design. Rather than applying a separate temperature factor, the CSA 086 code suggests that the designer apply the wet properties reduction factor when the member is subject to prolonged exposure to temperatures higher than 50°C (122°F). See Chapter 11 (Reference Information) of the Wood Design Manual (2010) for more information.

The **Concrete** entry indicates which concrete code is to be used in the design of concrete members and walls. For more information see [Concrete Design](#).

Note:

- ACI 318-08 and ACI 318-11 behave identically in the program, as there were no relevant changes between these two editions of the code.

The **Masonry** entry indicates which masonry code is to be used for the design of masonry walls. For more information see [Masonry Design](#).

Note:

- If the UBC 1997 ASD code is chosen, there is an option for whether the construction of the wall is subject to special inspection. This affects some values in design under that code.

Concrete

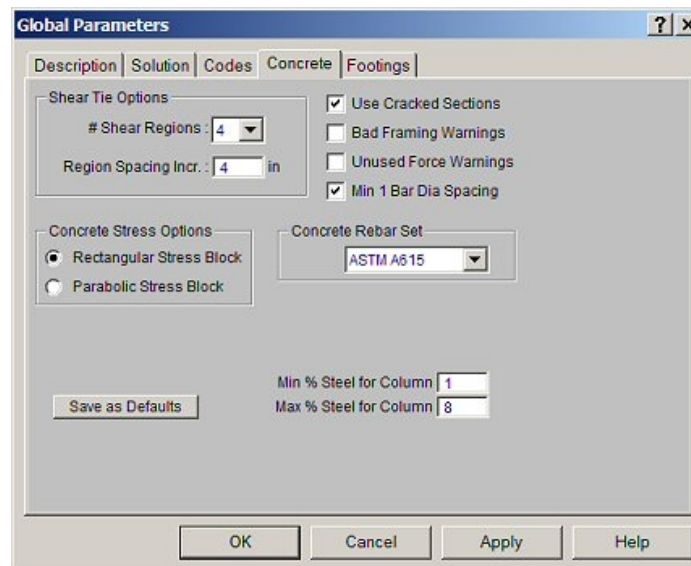

The entries under the **Concrete** tab contain options related to the analysis and design of concrete members.

The **Shear Tie Options** allow you to control the **Number of Shear Regions** that will be used when detailing a beam or column span. It also allows you to specify the increment that you'd like the program to use when increasing or reducing the spacing of the shear ties.

The **Concrete Stress Options** allow you to choose what type of stress block to consider in your analysis. The options are the constant **Rectangular Stress Block** and the **Parabolic Stress Block**. See [Parabolic vs. Rectangular Stress Blocks](#) for more information.

Check the **Used Cracked Sections** box if you want to modify the member and wall stiffnesses by the **Icr Factor** as described in both the [Concrete - Design](#) and [Wall Panels](#) topics.

Check the **Bad Framing** or **Unused Force Warnings** check box to see force warnings on the detail report or bad framing warnings in the Warning Log.

Checking the **Minimum 1 Bar Dia Spacing** box will allow a minimum spacing of one bar diameter between parallel bars. Otherwise, RISA will default to a two bar diameter or one inch clear spacing, whichever is greater, to allow for lap splices and continue to maintain adequate spacing between parallel bars.

The **Concrete Rebar Set** allows you to choose from the standard ASTM A615 (imperial), ASTM A615M ("hard" metric, i.e. #8M is an 8mm bar), BS 4449 (British), prENV 10080 (Euro), CSA G30.18 (Canadian), IS 1786 (Indian), and AS/NZS 4671:2001 (Australian/New Zealand) reinforcement standards.

The **Minimum % Steel for Columns** allows you to choose the minimum percentage of reinforcement steel to be used in a concrete column section. The percentage entered will be multiplied by the gross area of the column section to determine the minimum amount of reinforcement required in each column. It should be noted that the minimum percentage allowed by ACI 318-14 Section 10.6.1.1 (ACI 318-11 Section 10.9.1) is 1%.

The **Maximum % Steel for Columns** allows you to choose the maximum percentage of reinforcement steel to be used in a concrete column section. The percentage entered will be multiplied by the gross area of the column section to determine the maximum amount of reinforcement allowed in each column. It should be noted that the maximum percentage allowed by ACI 318-14 Section 10.6.1.1 (ACI 318-11 Section 10.9.1) is 8%.

Note:

Concrete cover for beams and columns is specified under Design Rules under the [Concrete Rebar](#) tab. Concrete cover for beams and columns is specified under Design Rules under the [Concrete Rebar](#) tab.

Graphic Display

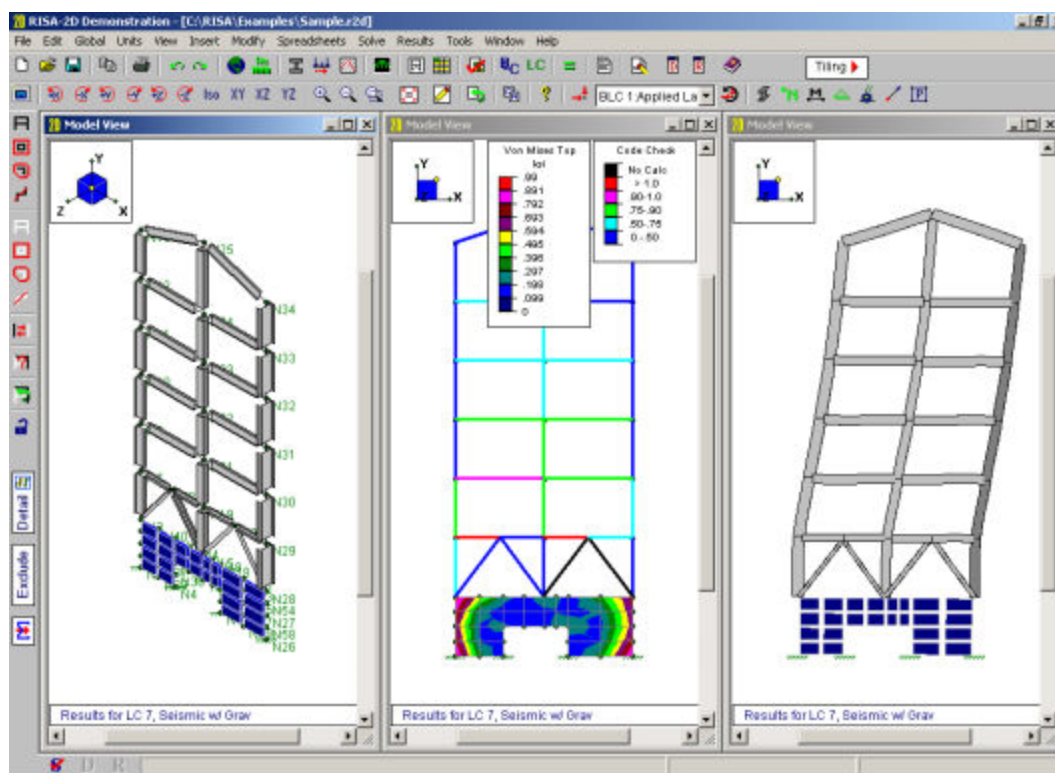

RISA-2D's robust graphics make building and understanding your model much easier. You may have numerous independent views open and active at the same time. Fast redraw times, responsive panning, true to scale rendering, animation capabilities, and graphic editing tools all help you build and understand your model. You may draw the model and specify loads and boundary conditions graphically. These items may be modified graphically as well. Verification of your model is made simple with true-to-scale rendering and color coded code checks. Results such as member force diagrams, color-coded stress levels, deflected shapes, and animations may also be viewed for solved models.

Multiple Windows



You may have multiple views of the model open at the same time, each with its own characteristics. For example you can simultaneously view and work with members in one window and plates in another. You can have multiple spreadsheets open as well.

To Open a New View or Clone an Existing View

- To open a new view of the model click the **New View**  button. Alternately, you can open a new view that is an exact replica of the current view by clicking the **Clone View**  button.

Note

- With the model view active you may then use the **Window Toolbar** to adjust the view of the model.

Controlling the Model View

The two main tools to help you manipulate the views of the model are the **Window Toolbar** and the **Model Display Options**.



The **Window Toolbar**, discussed in this section, is the second toolbar from the top when a model view is active. You may use these buttons to rotate the model, zoom in and out, render the model, and display common items such as joint labels, boundary conditions, and loads.



The **Model Display Options Dialog** (See [Model Display Options](#) for more information) is opened by the first toolbar button  and provides various options not otherwise available on the toolbar. It allows you to specify how to plot joints, members, plates, and loads and the information that is to accompany them. The tabs across the top of the dialog break things up into basic elements to help you find the options.

The **Snapshot tool**  is a great way to add images of model views and detail reports in your report printing. See [Printing](#) for more information.

Adjusting the Viewpoint

The remaining buttons on the **Window Toolbar** help you change the viewpoint by rotating, snapping, and zooming the view. You may use the scroll bars and the mouse wheel (if you have one) to pan the view.

To Rotate a View



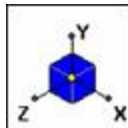

- When holding down the Shift key, the mouse wheel button can be used to dynamically rotate the structure. See [Application Interface - Dynamic Controls](#) for more information.
- To rotate a view of the model about a global axis, click any of the **Rotate** buttons on the **Window Toolbar**: 
- To snap to an isometric or planar view of the model click any of the **Snap** buttons on the **Window Toolbar**: 

Note

- As you rotate the view, the global X-Y-Z axis orientation is shown in the view.



To Zoom In and Out

- Use the wheel button on the mouse to dynamically zoom in or out the model view. Rotating the wheel forward zooms in and rotating the wheel backward zooms out.
- To zoom in towards the center of the model view click the **Zoom In**  button or press the + key.
- To zoom out from the center of the model view click the **Zoom Out**  button or press the - key.
- To zoom in on a specific area of the model view click the **Zoom Box**  button and then draw a box around the zoom area by clicking and dragging with the left mouse button.
- To snap the model to a full model view click the **Full Model View**  button.
- The Function Keys, F3 and F4, are for the Zoom Previous and Zoom Next functions respectively. The system holds a total of 10 zoom-states. The F3 or F4 keystroke moves the active pointer forward or backward on the list of zoom states. If multiple model views are present, each window will have its own zoom list.

To Pan the View

- Clicking and holding the mouse wheel button triggers a dynamic pan and allows the user to drag the current model view to the limits of scroll bars.
- If you do not have a mouse wheel you may drag the scroll bars and click the arrows to pan the view.

Enabling Graphic Editing

The **Graphic Editing Toolbar** or **Drawing Toolbar** may be turned on to graphically edit the model at any time and it may be turned off to provide a larger view. See [Graphic Editing](#) for more information.

To Toggle the Graphic Editing Toolbar

- To toggle the graphic editing toolbar on or off, click the  button on the **Window Toolbar**.

Saving Views

Click the  button to save and recall views. If you have a view that you like to work with or have created a view that took some time to set up, save it with this feature. All of the Model Display Options are saved with the model for later recall. See [Saving and Retrieving Model Views](#) for more information.

Cloning Views

You can clone a view. This allows you to preserve the original view and modify the clone. This is useful in achieving two views that have similarities in some way.

To Clone the Model View

- Click the **Clone View**  button on the **Window Toolbar**.

Displaying Loads

Use these buttons  to control the display of loads. You may display one basic load case or an entire load category or load combination. The first button turns the display of loads on and off in the current view. The pull down list controls which load case, category or combination is shown in the view. Click the last button to choose between plotting load cases, load categories or load combinations. More control over the display of loads is provided in the **Model Display Options Dialog** discussed in the next section.

Toggle Buttons

The last buttons on the **Window Toolbar** are toggles that plot information in the current view.

Click  to toggle model rendering. See [Model Display Options](#) for more information on rendering.

Click  to toggle the joint labels.

Click  to toggle the member labels on and off. If rendering is on, member labels will not be visible.

Click  to toggle display of member color basis.

Click  to toggle display of deflected shape.

Click  to toggle the I-J end flags.

Click  to toggle display of member results.

Click  to toggle the boundaries.

Click  to toggle the global axes orientation on and off in the view.

Click  to use the distance tool.

Click  to toggle display of reactions and moments.

Depth Effect

Right click in the model view and click **Depth Effect** on the **Shortcut Menu** to access the depth effect options. Depth effect is used to increase or decrease the "depth" effect of the plot. Increasing the depth effect causes points farther away from the screen to converge towards a vanishing point, giving the image a more realistic three-dimensional appearance. Removing the depth effect causes the vanishing point to become infinity (no vanishing point). The  button resets the view to have no depth effect.

Viewing Part of the Model

You may want to view only part of your model, especially if it is a big one. You may use the selection tools to give you the view that you want. You can graphically unselect parts of the model that you don't wish to see, or you can use a range of coordinates or other criteria to specify what to view. See [Graphic Selection](#) for more information.

Saving and Retrieving Model Views

You can save and recall views for a model. Saved views are model dependent so any views you save will stay with the model. A saved view includes information such as the current view angle, zoom state, pan location, plot option settings, etc. Saved views do NOT include the selection state for the model. You can save selection states separately. See [Saving Selections](#) for more information.



To Save the Model View

- Click the **Save View**  button on the **Window Toolbar**.
- Click the **Save** button and enter a name and then click **OK**.

To Retrieve a Saved Model View

- Click the **Save View**  button on the **Window Toolbar**.
- From the drop down list, choose the view you wish to recall and then click the **Retrieve** button.

To Delete a Saved Model View

- Click the **Save View**  button on the **Window Toolbar**.
- From the drop down list, choose the view you wish to delete and then click the **Delete** button.

Model Display Options

The Window toolbar (See [Graphic Display](#) for more information) offers some common graphical plotting choices, but these are just a few of the options available. Many more options are located in the **Model Display Options**

dialog which may be accessed by clicking the  button on the Window toolbar or pressing the F2 function key.

The options are organized into groups of items. Access each group by clicking on the tabs along the top of the dialog box. Some of the options are mutually exclusive and others are conditional. Typically, only one option in a vertical row may be chosen at a time and indented options will not be applied if the heading option is not also applied.

Each of the groups presents the option to turn off those particular items in the view. This is not the same as unselecting the items. Turning items on and off is independent from selecting and unselecting. For example if you make a selection of members and then turn off members all together, the selection still stands for any modification applied to members.

Defaults

You may make any Plot Option settings the default start-up settings. To do this, go through all the Model Display Options tabs and set all the options to what you want as the start-up default. Once that is done, select the **Misc** tab and press the button labeled **Make Current Plot Settings the Default**.

Note:

- Remember, this button applies to ALL tabs in the Model Display Options dialog.

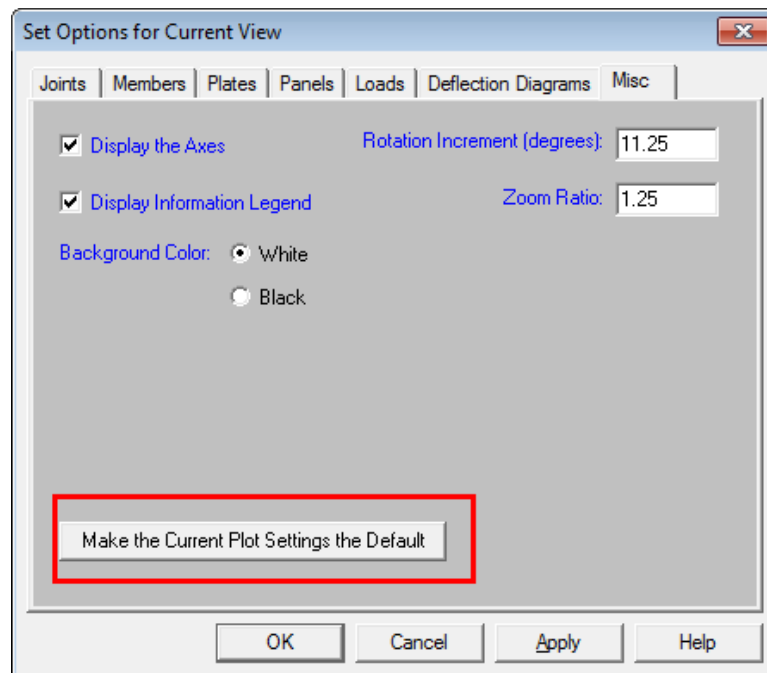

Joints

Access the graphical options for joints by clicking the **Model Display Options**  button on the Window toolbar and selecting the **Joints** tab shown below.

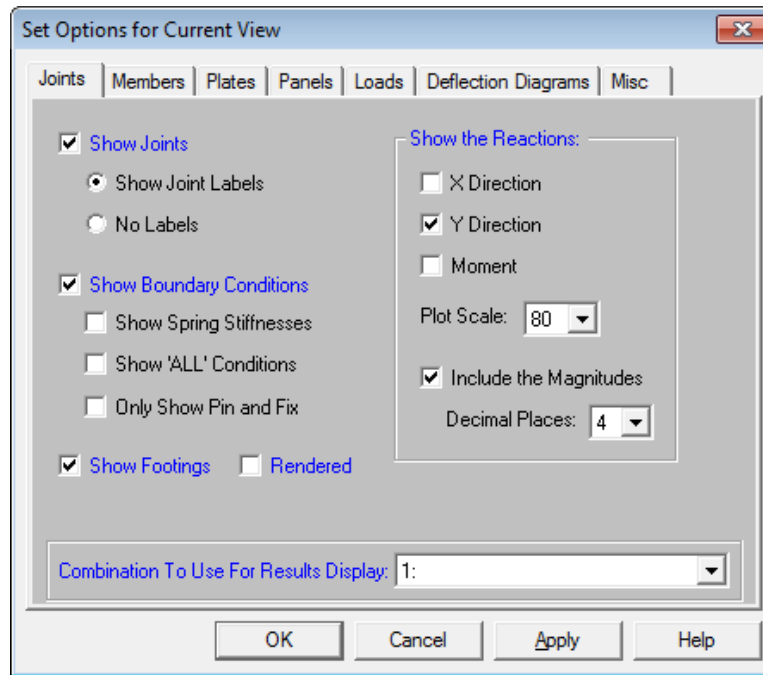

You may specify that **Joints** are, or are not, displayed and you may include the joint label.

You may display **Boundary Conditions** and as part of this option you may display any spring stiffnesses that you have specified. The “All” boundary condition will not be shown unless it is also specified.

If a single or a batch solution has been performed you may choose to show the **Reactions** in any of the three degrees of freedom and include the magnitudes. For Batch solutions you must choose which combination you want to view.

Members

Access the graphical Model Display Options for members by clicking the **Model Display Options**  button on the Window toolbar and selecting the **Members** tab shown below.

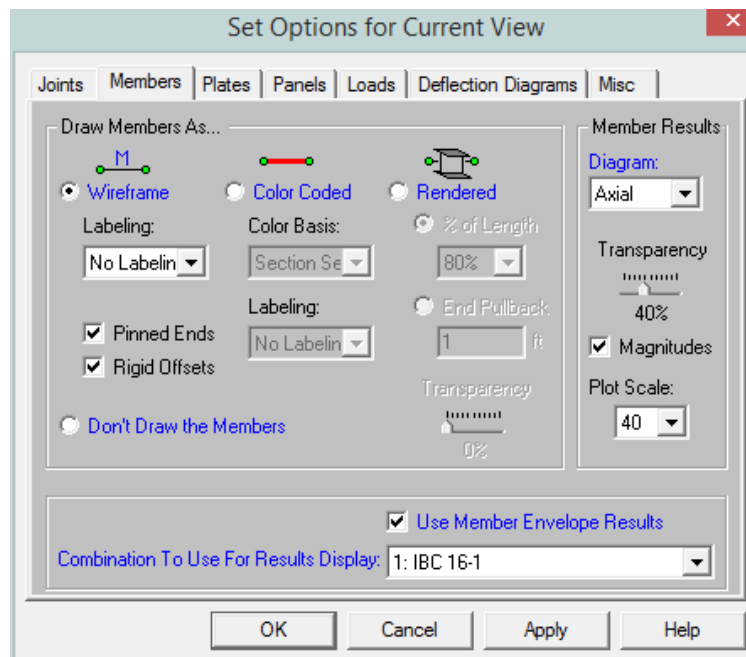

You may specify that no members are drawn, or you may draw them as Wireframe, Color Coded, or Rendered.

With the **Wireframe** and **Color-Coded** options you may include textual member information alongside each member. The **Labeling** drop down list provides the choices you have as to what information will be displayed alongside each member. The Wireframe option also allows you to display member Pinned End conditions and/or either Rigid End Offsets.

Color-Coding of members plots the members using various colors to represent particular information such as the section set assigned to each member, stress levels, etc. The **Color Basis** drop down list provides the choices you have as to how the colors are to be assigned to each member. If a single or batch solution has been performed you may color the members by the code check or the stress magnitudes. For batch solutions you must choose which combination you want to view. The key that defines these colors is shown in the upper right corner of the model view.

Note

- The **Tension** and **Compression** color coding options depend on the total axial tension or compression in the member. This includes the axial (tension or compression) stress plus the axial stress due to bending.

The **Rendering** option will produce true-to-scale renderings of the members. These may be rendered full length or pulled back by a specified distance or a percentage of the member length for a better understanding of complicated intersection areas and a better view of the member cross-section. This option is also very useful for verifying member orientations.

If the model has been solved you may also plot the member force **Diagrams** along each member and include the **Magnitudes**. You can also control the graphic scaling of these force diagrams. The diagrams themselves may be presented with varying degrees of **Transparency** with 100% transparency meaning an outline of the force diagram and 0% indicating a solid fill. If a batch solution has been performed you may also choose which combination you want to view.

Plates

Access the graphical Model Display Options for plates by clicking the **Model Display Options**  button on the Window toolbar and selecting the **Plates** tab shown below.

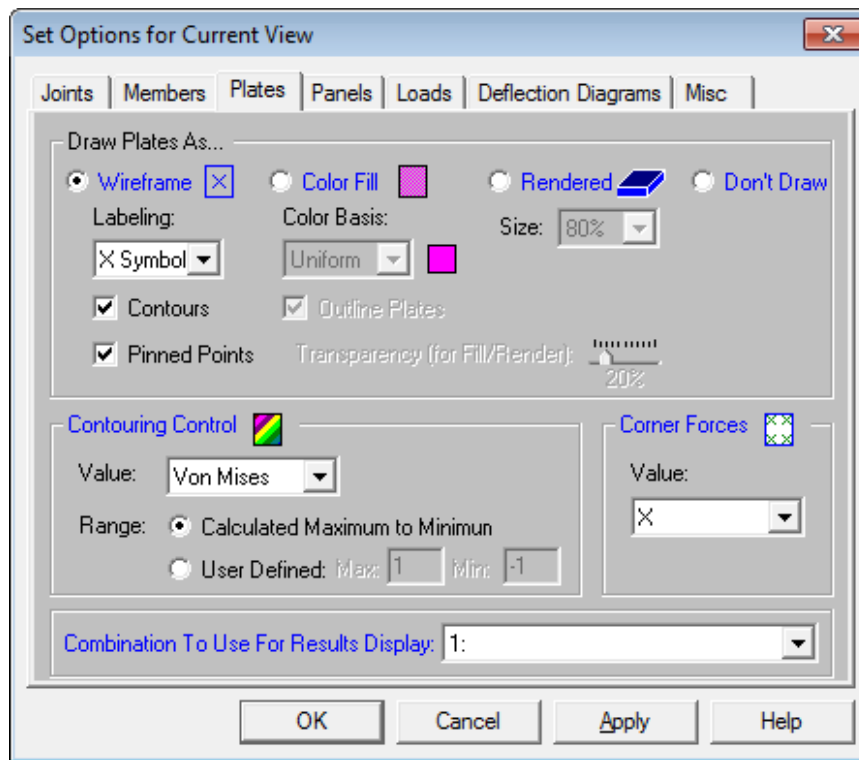

The **Draw Plates As...** section of this tab allows you to specify that plates are to be drawn as wireframe, color filled, or rendered elements, or that they are not to be shown at all.

When the **Wireframe** option is selected, you may include information on the plates when plotted. The **Labeling** drop down list provides the choices you have as to what information will be displayed on each plate, such as the plate label, material, thickness, or the plate local axes. If a single or batch solution has been performed, the wireframe option also allows for the display of line contours representing the force or stress results for the plates. Each color line represents a specific value. For batch solutions, you must choose which load combination you want to view in the **Combination To Use For Results Display** drop down list.

When the **Color Filled** option is selected, plates are plotted with different colors that are mapped in a key shown in the upper right corner of the model view. You may color the plates by material set or specify a uniform color for all plates. If a single or batch solution has been performed, you also have the option to plot the stress and force results using filled color contours where each fill color represents a range of values. The color filled plates themselves may be presented with varying **Transparency** with 100% transparency meaning completely see through and 0% indicating completely solid. For batch solutions you must choose which combination you want to view.

Note:

- The transparency setting does not apply when "**Contour**" is selected as the color basis from the drop down list.

The **Color Contours** are plotted with a global smoothing algorithm that allows the contour to vary across the plates. Because of this, the plotted contour results will differ slightly from the tabulated results in the spreadsheets. This effect will be heightened in regions of a high rate of change such as loads or boundaries. The contours may be drawn as either lines or as color filled areas.

The **Contouring Control** section determines what force or stress result is to be contoured and how the contour colors are to be assigned. The **Value** drop down list is where you select the specific result to be contoured (Fx, Von Mises, etc.). The **Range** controls determine how the contour colors are assigned. You can either contour the full range of the results by choosing **Calculated Maximum to Minimum**, or, if you are only interested in a specific range of values, you can choose **User Defined** and enter your own max and min values.

When the **Rendered** option is selected, true to scale representations of the plates will be drawn with thickness. You may also display the rendered plates at a percentage of their size. This is useful in understanding orientation and connectivity in complex views as shown below.

Along with any of the above options you may also plot the plate **Corner Forces**. These are the global direction forces applied to the corners of the plates that hold them in equilibrium. The **Value** drop down list is used to pick which corner force (or moment) is to be displayed. For batch solutions you must choose which combination you want to view.

The **Transparency** setting described above for Color Filled plates also applies to Rendered plates.

Panels

Access the graphical Model Display Options for panels by clicking the **Model Display Options**  button on the Window toolbar and selecting the **Panels** tab shown below.

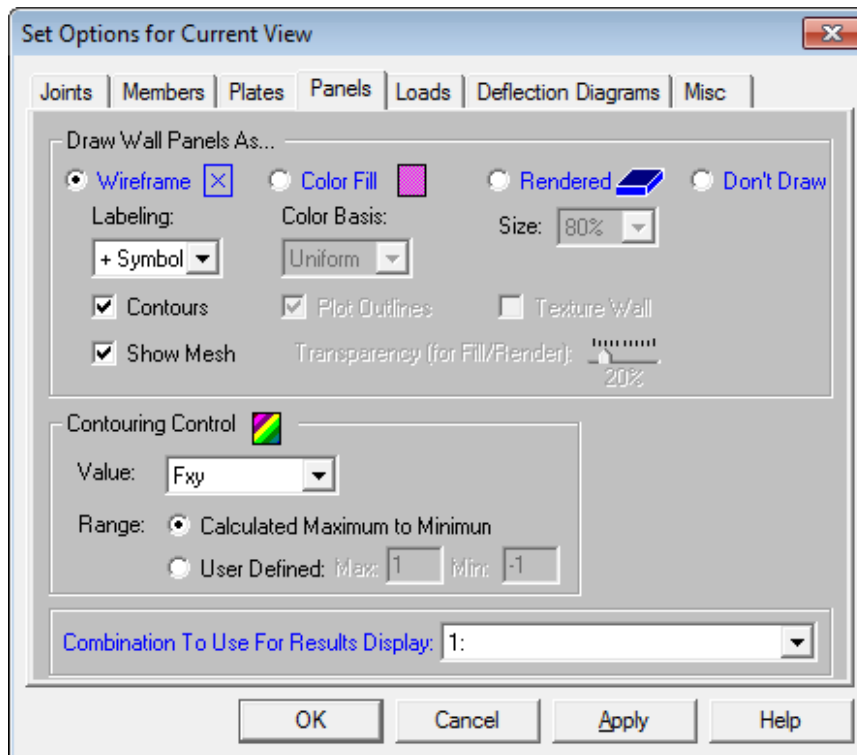

The **Panels** section of this tab allows you to specify that panels are to be drawn as wireframe, color filled, or rendered elements, or that they are not to be shown at all.

When the **Wireframe** option is selected, you may include information on the panels when plotted. The **Labeling** drop down list provides the choices you have as to what information will be displayed on each panel, such as the panel label, material, or the panel number. If a single or batch solution has been performed, the wireframe option also allows for the display of line contours representing the force or stress results for the panels. Each color line represents a specific value. For batch solutions you must choose which load combination you want to view in the **Combination To Use For Results Display** drop down list. You also have the option to see the mesh that the program automatically creates internally for all Wall Panels.

When the **Show Mesh** option is selected, panels are plotted showing the internal plate mesh automatically generated during a solution. This is useful for verifying and understanding how the forces/stresses are distributed within a panel.

When the **Color Filled** option is selected, panels are plotted with different colors that are mapped in a key shown in the upper right corner of the model view. You may color the panels by material set or specify a

uniform color for all panels. If a single or batch solution has been performed then you also have the option to plot the stress and force results using filled color contours where each fill color represents a range of values. The color filled panels themselves may be presented with varying **Transparency** with 100% transparency meaning completely see-through and 0% indicating completely solid. For batch solutions you must choose which combination you want to view.

Note:

- The transparency setting does not apply when "**Contour**" is selected as the color basis from the drop down list.

The **Color Contours** are plotted with a global smoothing algorithm that allows the contour to vary across the panels. Because of this, the plotted contour results will differ slightly from the tabulated results in the spreadsheets. This effect will be heightened in regions of a high rate of change such as loads or boundaries. The contours may be drawn as either lines or as color filled areas.

The **Contouring Control** section determines what force or stress result is to be contoured and how the contour colors are to be assigned. The **Value** drop down list is where you select the specific result to be contoured (Qx, Fx, Mx, Von Mises, etc.). The **Range** controls determine how the contour colors are assigned. You can either contour the full range of the results by choosing **Calculated Maximum to Minimum**, or, if you are only interested in a specific range of values, you can choose **User Defined** and enter your own max and min values.

When the **Rendered** option is selected, true to scale representations of the panels will be drawn with thickness. You may also display the rendered panels at a percentage of their size. This is useful in understanding orientation and connectivity.

Loads

Access the graphical Model Display Options for loads by clicking the **Model Display Options**  button on the Window toolbar and selecting the **Loads** tab shown below.

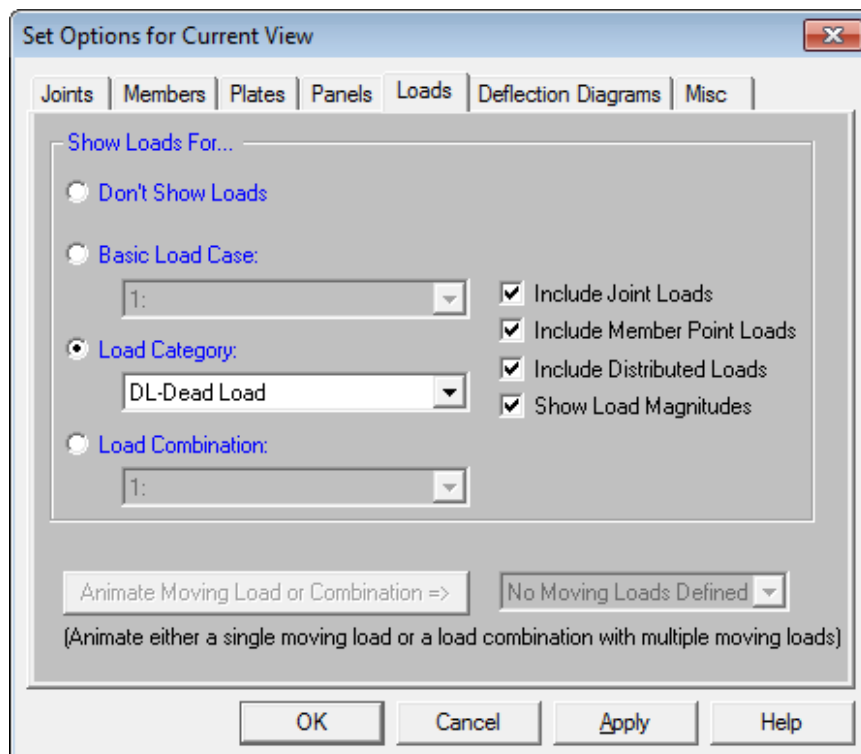

You may specify that the loads be drawn as Load Cases, Load Categories or Load Combinations by selecting the corresponding radio button. The load types to be displayed can be selected by checking the corresponding boxes.

Once you set the Model Display Options for loads, you may then run through all of the load cases, load categories or load combinations by choosing them from the drop down list

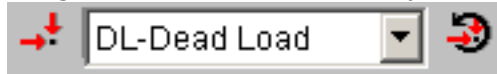

on the Window toolbar.

You may also animate any **Moving Loads** by selecting them from the drop-down list and then clicking on the **Animate** button. This will produce an animation in a new model view window. Use the arrow buttons or slider bar to adjust the speed of the animation. You may pause the animation and use the step number entry to jump to a particular time step.

In the model view of the moving loads, the **Capture** feature allows users to save video file format of the moving loads. To use this feature, adjust to the desired number of frames and click on the video button. The user will be prompted to save the video file.



Deflection Diagrams

Access the Model Display Options for deflections by clicking the **Model Display Options**  button on the Window toolbar and selecting the **Deflection Diagrams** tab shown below.

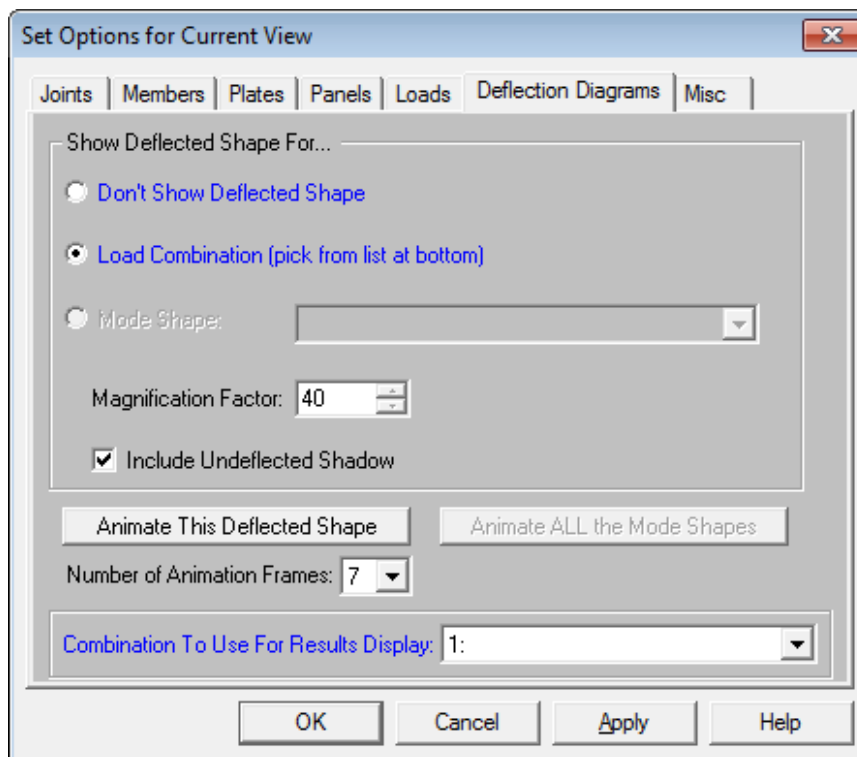

In the **Show Deflected Shape For...** section of the tab you may specify that a deflected shape be drawn in the current model view based on either a load combination (if a single or batch static solution has been done) or a mode shape (if a dynamic solution has been done). You can control the magnification of the deflections with the **Magnification Factor** text box and specify whether an undeformed shadow is to be shown by checking the **Include Undeformed Shadow** box. For batch solutions you must choose which combination you want to view in the **Combination To Use For Results Display** drop down list.

To animate a particular deflected shape, first select the deflected shape (as described above) and then simply click the **Animate This Deflected Shape** button. A new model view will be created with the animation. The **Number of Animation Frames** drop down list allows you to specify how many frames are used in the animation to move from the undeflected state of the model to the fully deflected state.

In the model view of the animated deflected shape, the **Capture** feature allows users to save video file format of the animated deflected shape. To use this feature, adjust to the desired number of frames and click on the video button. The user will be prompted to save the video file.



Note:

- The animation that is created is placed behind the original view. You may shrink the original view or use the **Window** menu to bring the animation into view.

For additional advice on this topic, please see the RISA Tips & Tricks webpage at risa.com/post/support. Type in Search keywords: **Deflected**.

Miscellaneous

Access miscellaneous plotting options by clicking the **Model Display Options**  button on the Window toolbar and selecting the **Misc** tab shown below.

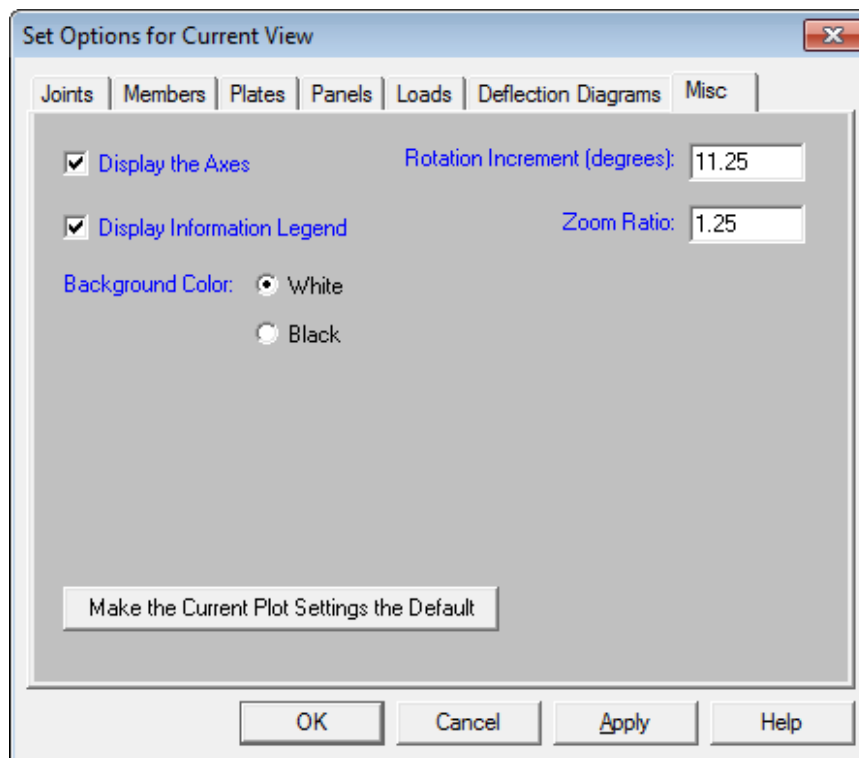

You may indicate whether the global axes icon is to be displayed in the upper left corner of the model view by checking the **Display the Axes** box. You also have the option of displaying the informational legend drawn in the bottom left corner of the model view by checking the **Display Information Legend** box. This legend has information such as which combination has been solved, which loads are being displayed, etc.

You may specify whether the **Background Color** for the model view is to be black or white by clicking the corresponding radial button. A black background shows colors more vividly, but a white background shows a more realistic representation of what you'll get if you print the graphic view.

By entering values in the text boxes, you may control the **Rotation Increment** and **Zoom Ratio** that will be used with each click of the corresponding toolbar buttons on the **Window Toolbar**.

Finally, you may make any plot option settings the default startup settings. To do this, go through all the Model Display Options tabs and set all the options to what you want as the startup default. Once that is done, press the **Make Current Plot Settings the Default** button. This button applies to ALL the Model Display Options tabs.

Graphic Editing

You may draw, edit, and load your model directly in the model views. You can draw members and plates between existing joints or draw to grid intersections and have the joints created automatically. You may graphically select joints to be restrained, members to be loaded, and plates to be submeshed. All or selected parts of the model may be moved, copied, and/or modified allowing you to quickly model and edit your structure. See [Graphic Selection](#) to learn how to make selections.

Drawing and Modification Features

There are several graphic editing features that make the creation and modification of models quite easy. Use the **Insert** and **Modify Menus** or the **Drawing Toolbar** to utilize these features in the model view. To create new members, plates, etc., you can draw them using a drawing grid or draw "dot to dot" from existing joints. Once you have created these items you may use other graphic features to load the model and set boundary conditions.

- See [Members](#) for more information on drawing and modifying **Members**.
- See [Plates/Shells](#) for information on drawing and modifying **Plates/Shells**.
- See [Boundary Conditions](#) for information on creating and modifying **Boundary Conditions**.
- See [Loads - Point Loads](#) for information on drawing **Point Loads**.
- See [Loads - Joint Force / Displacement](#) for information on drawing **Joint Loads**.
- See [Loads - Distributed Loads](#) for information on drawing **Distributed Loads**.

All model data is automatically recorded in spreadsheets and the spreadsheets and model views are always in tune (unless you turn this feature off in the **Application Settings** on the **Tools Menu**). As you edit a model graphically the spreadsheets are automatically updated and as you make changes in the spreadsheets the model views reflect these changes immediately.

All of the graphical modeling tools may be found on the **Drawing Toolbar** shown below. This toolbar may be turned on and off by clicking the  button on the **Window Toolbar**.



Where to Start

The [Drawing Grid](#) is often useful when you are starting a new model from scratch or adding a new section to a model. It allows you to set up grid lines which may then be used to define the members, plates, and boundaries. The Drawing Grid is independent of the model so you may change the grid and place it anywhere, without affecting the model and whenever it is convenient.

There are also times when it is simpler to define joints in the spreadsheet and then draw the members or plates between them. This might be the case if you are working with just a few joints, or if the structure is irregular and does not lend itself to a grid.

Apply Options

Some of the graphic editing options offer more than one way to apply a modification. This is because there are times when each option is useful. For example, changing the material of a beam from A36 steel to A572 steel can be accomplished using the **Members Spreadsheet**. If you had to apply this change to 100 beams however you would not want to do that for each of them. A better way to do this would be to graphically select all of the beams and then apply the changes all at once.

Use the following options to specify how you want to choose the items to modify. Choosing **Apply Entries to All Selected Items** allows you to use the tools on the **Selection Toolbar** to choose the items you want and then

apply the modifications to all selected items at once. Choose **Apply Entries by Clicking Items Individually** to then click on the items you wish to modify individually. See [Graphic Selection](#) for more information on the selection tools.

Note

- The selection and viewing tools override the graphic editing modes so that as you are editing the model you can alter the selected state. You will be returned to the current editing mode when you exit a selection mode.
- You may also double click any joint, member, or plate to view and edit it's properties.
- To correct any modeling errors it is a good idea to run **Model Merge** before performing a solution. Becoming familiar with this feature will also allow you to take shortcuts while modeling. See [Model Merge](#) for more information.

Undo Operations

RISA-2D provides you with unlimited 'Undo' capability so that you may easily correct mistakes or just back up to try different possibilities. Simply click the  button on the **RISA Toolbar** as many times as you wish to undo your previous actions. The model view and the spreadsheets will visually display the "undoing". Remember that spreadsheet edits are undone as well.

Note

- Changes made to the selection state of the model, the zoom level or rotation of the model view, or to the Model Display Options settings are NOT undone. Only a change to the model data can be undone.

Redo Operations

RISA-2D provides you with unlimited 'Redo' capability so that you may easily redo any actions that were previously undone using the 'Undo' button. Simply click the  button on the **RISA Toolbar** as many times as you wish to redo actions that were previously undone. The model view and the spreadsheets will visually display the "redoing". Remember that spreadsheet edits are redone as well.

Note



- Changes made to the selection state of the model, the zoom level or rotation of the model view, or to the Model Display Options settings are NOT redone, since they cannot be undone to begin with. Only a change to the model data can be redone.

The generator provides the ability to generate an entire grid system at once rather than entering the grids in manually in the project grid spreadsheet.

Drawing Grid

The **Drawing Grid** is a tool that lets you draw new members and plates in the model view. This grid is independent of the model, so you may change the grid as you build your model without changing any modeling that you have completed. This is because as you draw the members and plates the joints used to define them are created automatically. These joints remain in their locations if the grid is relocated.

Drawing Grid Dialog

Click the  button on the **Drawing Toolbar** to open the **Drawing Grid Dialog** shown above. The display of the **Drawing Grid** in the current model view may be turned on and off by clicking the  button on the **Drawing Toolbar**. If the Drawing Toolbar is not visible in the current model view, click the  button on the **Window Toolbar**.

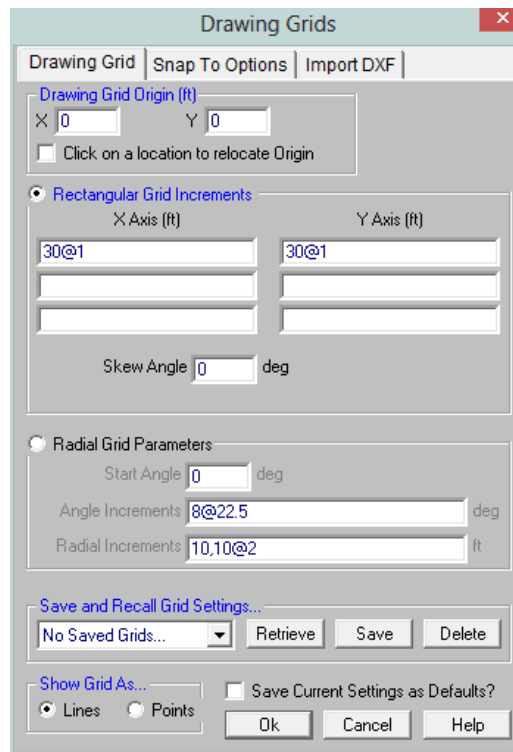

You may choose between a rectangular drawing grid or a radial drawing grid. Also, rectangular drawing grids may be skewed from perpendicular to the global axis plane.

The **Save and Recall Grid Settings...** section allows for drawing grids may be saved and recalled for later use. Saved drawing grids are model independent, i.e. when you save a grid, you can reuse it in any other model you are working with in the future. To save a drawing grid, click the **Save** button after defining the grid. You will be prompted for a name for the drawing grid and it will then be saved and added to the list of grids available for recall. To recall a previously defined drawing grid, select the grid name from the drop down list and click the **Retrieve** button. If you wish to delete a previously saved drawing grid, select the grid name you want to delete from the drop down list and click the **Delete** button.

The **Show Grid As...** section gives the option of displaying the drawing grid as lines from grid point to grid point or simply as a grid of points.

You may save any of the grid information as the default setting so that when you start a new model that information is already there. To do this, simply enter the information that you want to save in the **Drawing Grids Dialog**, check the **Save Current Settings as Defaults** box, and then click the **OK** button.

Rectangular Drawing Grid

The rectangular drawing grid is defined by increments in two directions. The **Drawing Grid Origin** is where you want the grid increments to start. The **Rectangular Grid Increments** are the distances between the grid points or lines in two global directions.

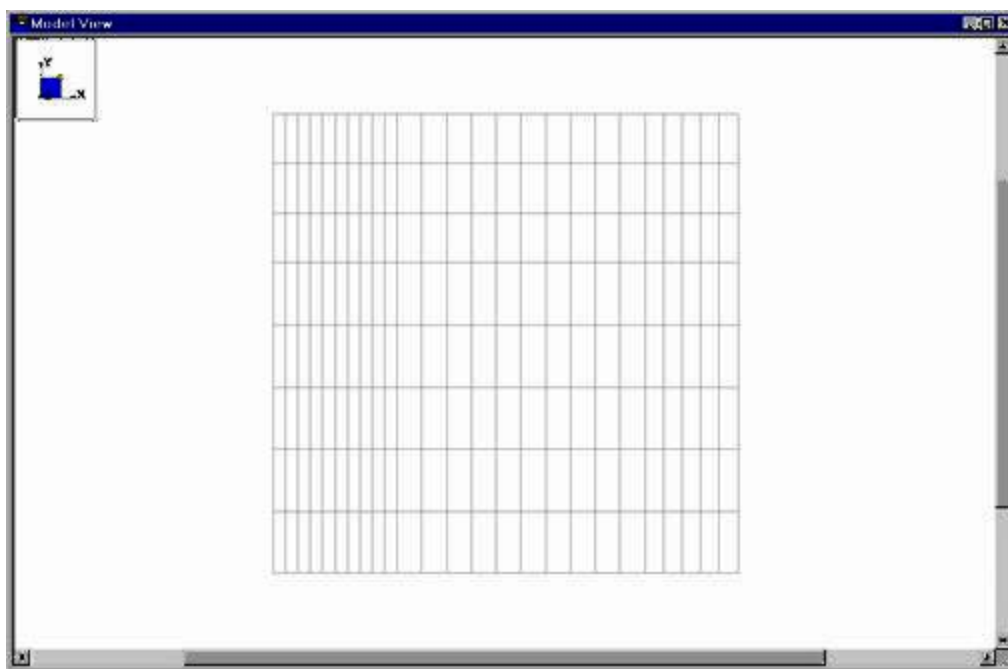

You may use symbols such as "@", "/" and "," when entering the drawing grid increments.

The "@" entry may be used to specify multiple, equally spaced, grid increments. For example, if you wanted 7 increments at 10 units each, you would type "7@10" in the increment field.

The "/" entry subdivides a larger increment into smaller equal increments. For example, the entry "12/4" would create 4 increments of 3 units each.

Use commas (",") to enter multiple increments in the increment field. For example, if you wanted to define increments of 3, 4, 7 and 2 units, you could enter "3,4,7,2" in the increment field.

Once the drawing grid is specified and displayed in the model view, it will provide snap points while drawing your model.

Skewed Drawing Grid

The rectangular drawing grid can be skewed by specifying a skew angle. This option is available in the **Rectangular Grid Increments** section of the **Drawing Grids Dialog**. This skew angle will allow the creation of a regular rectangular drawing grid, but displayed in the model view at the specified angle, inclined from the global axis.

Radial Drawing Grid

Increments in two polar directions define a radial drawing grid. The **Drawing Grid Origin** is the point about which the grid will rotate. The default is at the global origin (0,0). The **Start Angle** defines the angle from the global axis that the first spoke will be drawn. The **Angle Increment** controls the number and angular spacing of the spokes in the grid. The **Radial Increments** controls the number and location of the rings in the grid.

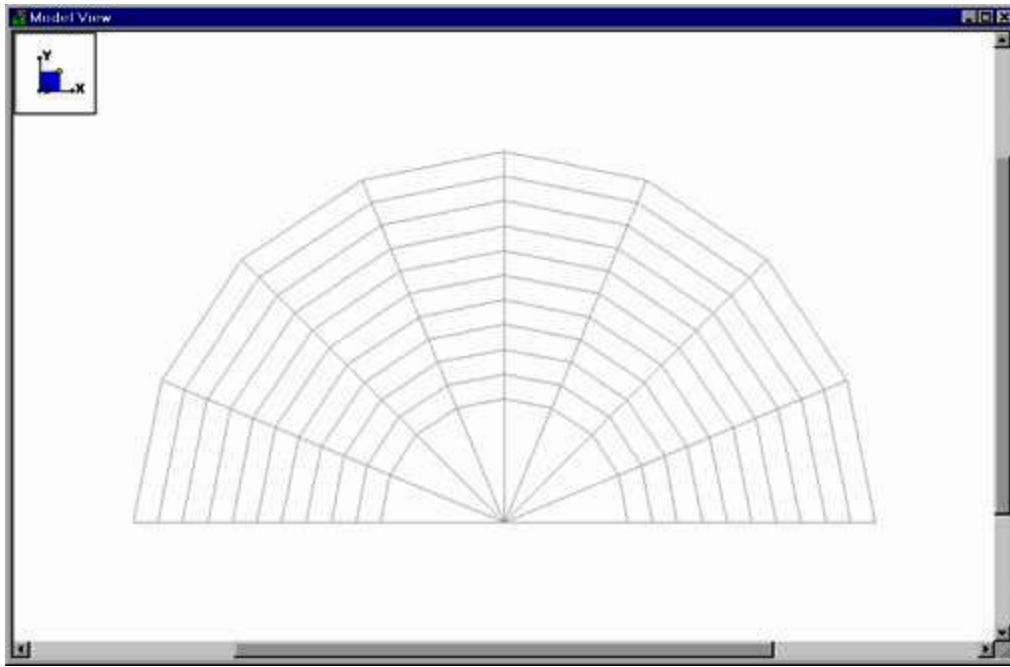

Relocating the Drawing Grid



The origin of the drawing grid may be specified in two ways. The first is to enter the exact global coordinates for the origin. This can be done by entering the values in the X and Y fields of the **Drawing Grid Origin** section. The second option is to specify the origin by clicking on an existing point in the model. This option is available by checking the **Click on a location to relocate Origin** box, clicking the **OK** button, and then clicking on the specific location in the model view where you wish the drawing grid origin to be located. The drawing grid origin will then be moved to this point.

Snap Points

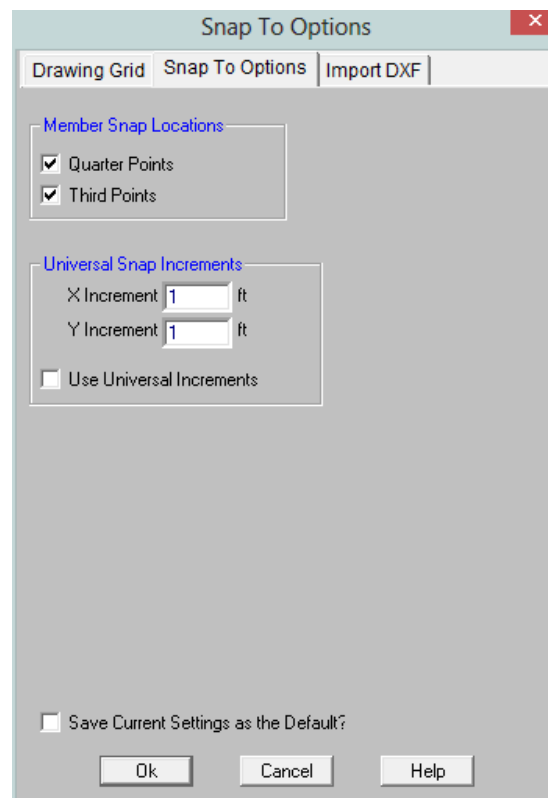
Snap Points let you draw in the model view without the use of grids. To view or modify the snap point settings, click the button on the **Drawing Toolbar** and select the **Snap To Options** tab shown below.



In the **Member Snap Locations** section, you can set the program to automatically snap to the **Quarter Points** and/or **Third Points** of a member by checking the appropriate boxes.



The **Universal Snap Increments** section is used to define a snap grid for "free" drawing to any incremental location on a plane. To activate this feature, check the **Use Universal Increments** box. Or, the feature may be toggled on and off in the current model view by clicking the  button on the **Drawing Toolbar**. If the Drawing Toolbar is not visible in the current model view, click the  button on the **Window Toolbar**.

When snap points are activated, a red dot or asterisk will appear on your screen as you move your drawing cursor over one of these points. The exact coordinates of this point, and whether it is a 1/3 or 1/4 point of a member, are reported in the status bar at the very bottom of the main application window just beneath the workspace.

Import DXF

Import DXF lets you import a DXF drawing into the model view as a grid. The DXF image is imported so that you can snap to any point or intersection to aid in the drawing of your model. The DXF Import Drawing Grid supports Lines, Polylines, Circles, Arcs, Polylines with Arcs, and Points.

To Import DXF Drawing Grid:

1. If there is not a model view already open then click  on the **RISA Toolbar** to open a new view and click  to turn on the **Drawing Toolbar** if it is not already displayed.
2. Select the Drawing Grid Origin or click to checkbox to manually locate it after the dialogue closes.
3. Assign the DXF Import Options and DXF Plane.
4. Select Lines or Points for grid lines.
5. Select the DXF File from a file or from the list of recently used files. The program will remember the last 5 files imported.

- Once the file is imported, you will be prompted to "Use All Layers" or "Select Layers from the List". You can check or uncheck selected layers, and select colors of the layers display by clicking on the gray box (defaults to gray).

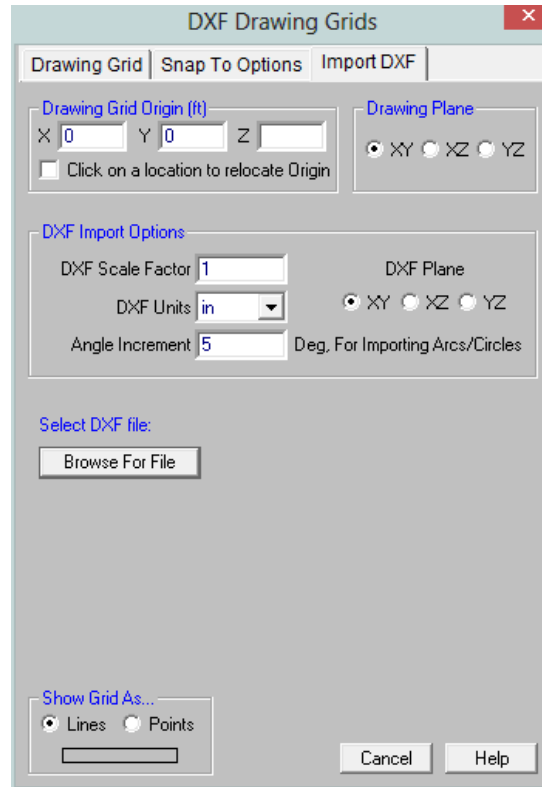

The program will default to use All Layers. Or you can select the color of the grid lines/points by clicking on the color box next to each layer name and select the color.

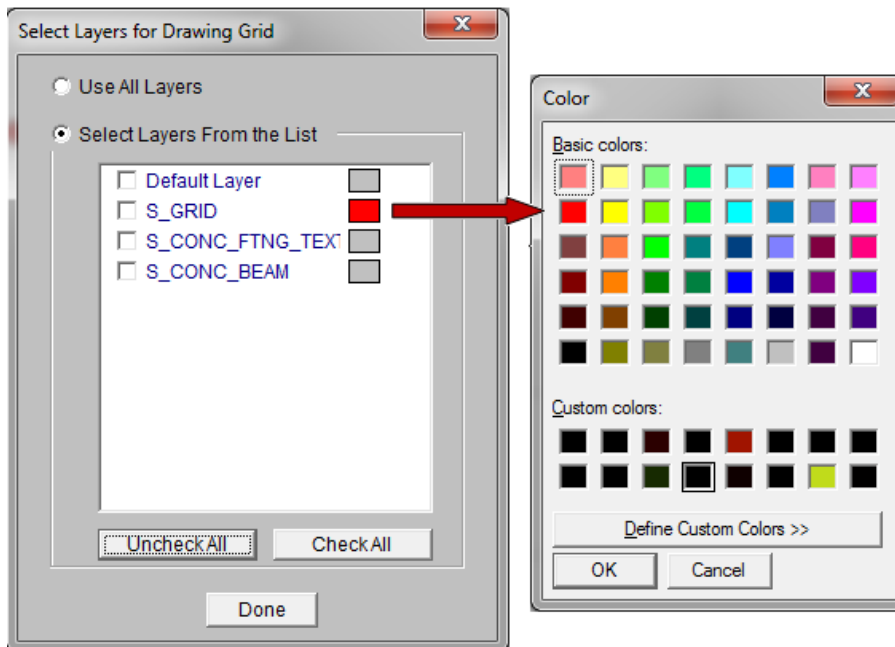

Locating the DXF Drawing Grid

The origin of the drawing grid may be specified in two ways. The first is to enter the exact global coordinates for the origin. This can be done by entering the values in the X and Y fields of the **Drawing Grid Origin** section. The second option is to specify the origin by clicking on an existing point in the model. This option is available by checking the **Click on a location to relocate Origin** box, clicking the **OK** button, and then clicking on the specific location in the model view where you wish the drawing grid origin to be located. The drawing grid origin will then be moved to this point.

Drawing Plane

Select the RISA drawing plane for the DXF file shall be placed.

DXF Scale Factor

Enter the scale factor that will cause the DXF file to be scaled up or down to full scale. For instance, if you had created a scaled model in AutoCAD at a scale of 1/4"=12", then the appropriate scale factor to produce a full size RISA-2D model would be 48. The default is 1.0.

DXF Plane

Select the DXF drawing plane to import from the DXF file. The DXF file will be flattened to this plane and all lines/points visible from this plane will be imported.

DXF Units





Select the units you used in the CAD model from which you produced the DXF file. The supported DXF units are none, inches, feet, mm, cm, and meters.

Angle Increment

The program will break an arc or circle into straight line segments to allow you to snap to them. This indicates the number of degrees that an imported arc or circle should be broken into.

Copying Model Elements

To Copy Selected Items

1. If there is not a model view already open then click  on the **RISA Toolbar** to open a new view and click  to turn on the **Drawing Toolbar** if it is not already displayed.
2. Select the items you want to copy.
3. To copy the selection *linearly* click the **Copy**  button
4. To *mirror* the selection click the **Mirror Copy**  button and specify the mirror plane.

Note:

- Use the "@" symbol to specify multiple equal increments. For example specifying "3@10" will give you 3 copies at 10 units apart.
- You may undo any mistakes by clicking the **Undo**  button.

Copy by Increments

This allows you to copy the selected items by entering in increments in any or all of the global directions. The selected items will copy the increment distance(s) that you have entered.

Use the "@" symbol to specify multiple equal increments. For example specifying "3@10" will give you 3 copies at 10 units apart.

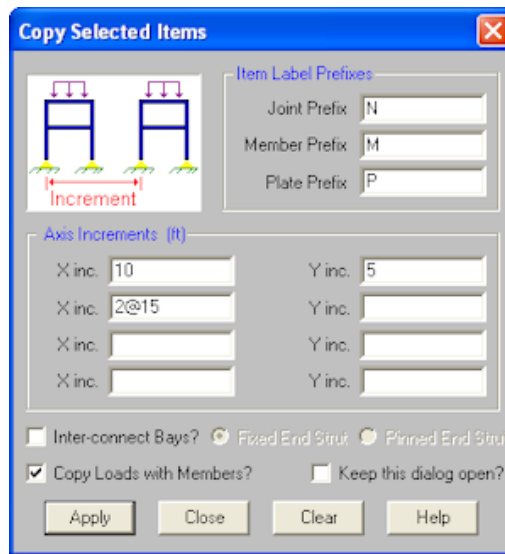

Checking the **Copy Loads with Members?** box will cause ALL loads associated with the original selected model elements to be copied to the corresponding newly created model elements.

Checking the **Inter-connect Bays?** box will cause new members to be generated that connect all member end joints of the originally selected model elements with the corresponding member end joints in the newly created model elements. You may also indicate whether the new member end releases are to be **Fixed** or **Pinned** by selecting the corresponding radial button.

Note:

- Only member end joints will be inter-connected. The corner joints of Plates and Solids will NOT be inter-connected.
- Member end joints that have a boundary condition associated with them will NOT be inter-connected.

Rotate Copy

You can copy the selected part of the model by rotating the copies. Simply enter the sweep angle, the number of increments along the sweep (rotation) angle, and the location of the polar origin (the point rotated about).

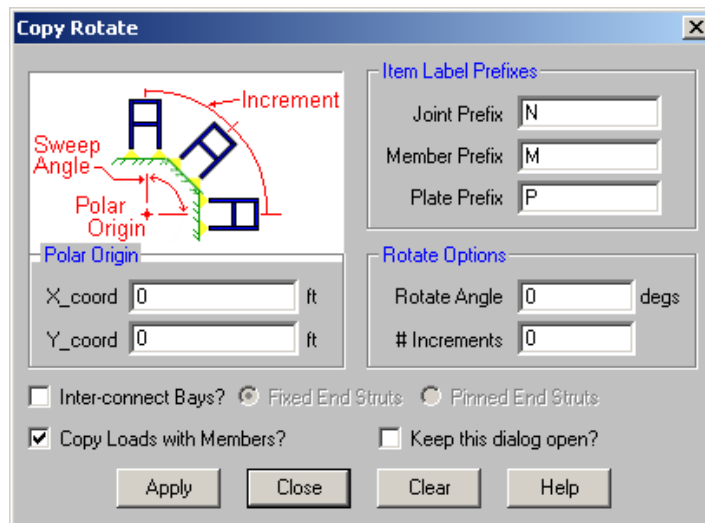

For example, suppose you wish to copy the selected part of your model in six 30° increments (for a total of 180°). You would enter "180" as the sweep (rotation) angle and "6" as the number of increments. For the polar origin, enter the X and Y coordinates of where you want the axis of rotation to pass through the XY plane.

Checking the **Inter-connect Bays?** box will cause new members to be generated that connect all member end joints of the originally selected model elements with the corresponding member end joints in the newly created model elements. You may also indicate whether the new member end releases are to be **Fixed** or **Pinned** by selecting the corresponding radial button.

Note

- Only member end joints will be inter-connected. The corner joints of Plates and Solids will NOT be inter-connected.
- Member end joints that have a boundary condition associated with them will NOT be inter-connected.

Checking the **Copy Loads with Members?** box will cause ALL loads associated with the original selected model elements to be copied to the corresponding newly created model elements.

Mirror Copy

You can mirror selected parts of your model. Enter the global axis that you want to mirror about and enter a location along the normal axis to move the mirror plane location. If the mirror plane location is left blank, the mirror plane is placed at the origin.

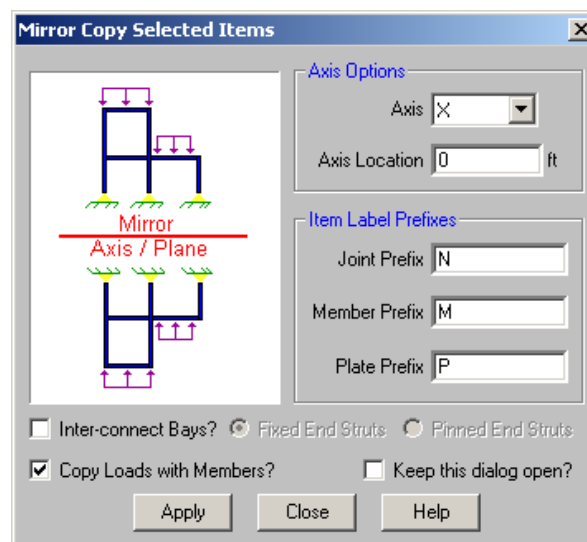

For example, suppose you want to mirror part of your model about the X axis at a location +3.0 feet from the origin. You would enter "X" as the Axis and enter a "3.0" for the axis location.

Checking the **Inter-connect Bays?** box will cause new members to be generated that connect all member end joints of the originally selected model elements with the corresponding member end joints in the newly created model elements. You may also indicate whether the new member end releases are to be **Fixed** or **Pinned** by selecting the corresponding radial button.



Note

- Only member end joints will be inter-connected. The corner joints of Plates and Solids will NOT be inter-connected.
- Member end joints that have a boundary condition associated with them will NOT be inter-connected.

Checking the **Copy Loads with Members?** box will cause ALL loads associated with the original selected model elements to be copied to the corresponding newly created model elements.

Moving and Rotating Model Elements

To Move or Rotate Selected Items

1. If there is not a model view already open then click  on the **RISA Toolbar** to open a new view and click  to turn on the **Drawing Toolbar** if it is not already displayed.
2. Select the items you want to move.
3. To move the selection linearly click the **Move Linear**  button and specify the offset distances.

To move the selection in a polar fashion click the **Rotate**  button and specify the axis and angle.

Note:

- You may undo any mistakes by clicking the Undo  button.

Linear Move

You can move the selected part of the model. Just enter the desired translation distances in the global axes directions.

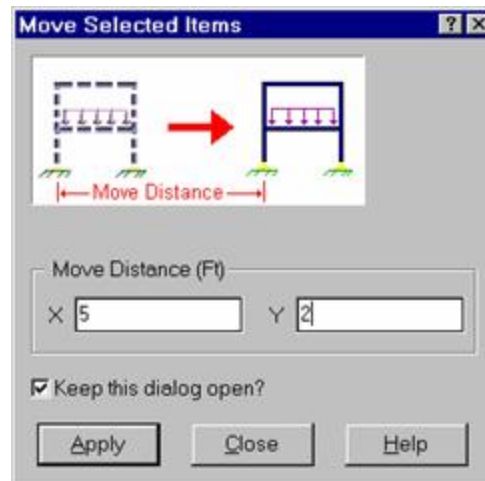

Rotate Move

To rotate the selected parts of the model enter the desired rotation angle and the coordinates of the polar origin (the point rotated about). Instead of specifying coordinates for a polar origin, it may instead be chosen by clicking in the model view. Select **Click Joint in Model View**, specify the appropriate Rotation Axis and Rotation Angle, then click **Apply**. The cursor will show a crosshair, with which a polar origin may be specified by left-clicking on a Joint or snap point.

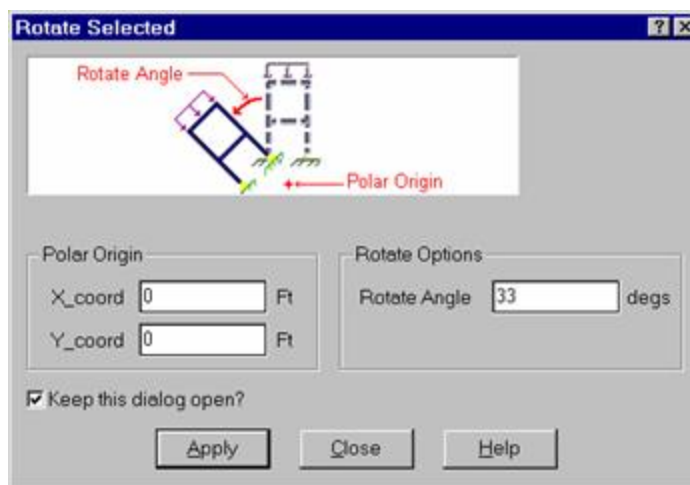

For example, say you wish to rotate the selected part of your model 90°. You would enter "90" as the rotate angle. For the polar origin, enter the coordinates of where you want the axis of rotation to pass through the XY plane.

Scaling Elements

The scale feature allows you to change the size of selected items. Selected joints, members and plates are all affected when the scaling is applied. Loads are not scaled except distributed and surface loads that are a function of the size of the element.

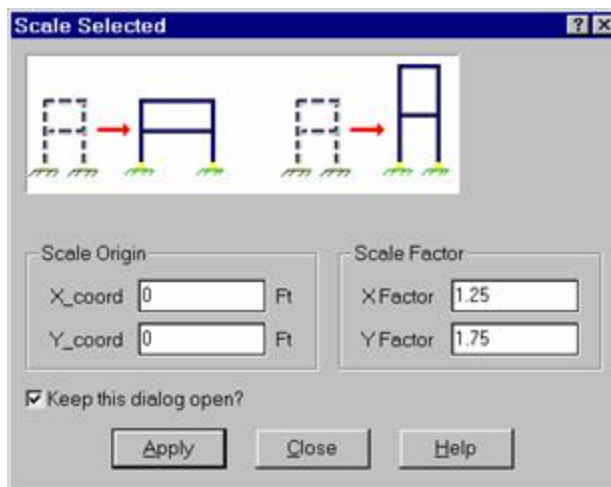





Enter an origin about which to scale and a scale factor to apply to each global direction. The origin is the point that remains stationary during the scaling. The factors are applied in each direction to adjust the joint coordinates, member lengths and plate sizing. The factors work so that a factor of one has no affect, a factor of two will double the size of the item, and so on.

What is actually happening when you scale items is that the joint coordinates that define these items are being moved. For this reason the scaling is applied to all selected items plus unselected joints of selected items. For example if you have selected members to scale but have unselected some of the end joints, the joints are scaled anyway since this is the only way to scale the member.

Note

- If you wish to scale in a direction other than a global direction you can rotate the model to a global direction, scale it, and rotate it back.

To Scale Selected Items

1. If there is not a model view already open then click  on the **RISA Toolbar** to open a new view and click  to turn on the **Drawing Toolbar** if it is not already displayed.
2. Select the items you want to copy.
3. To scale the selection click the Scale  and specify the scale factors for each direction. For help on an item, click  and then click the item.

Note



- You may undo any mistakes by clicking the Undo  button.

Merging Model Elements

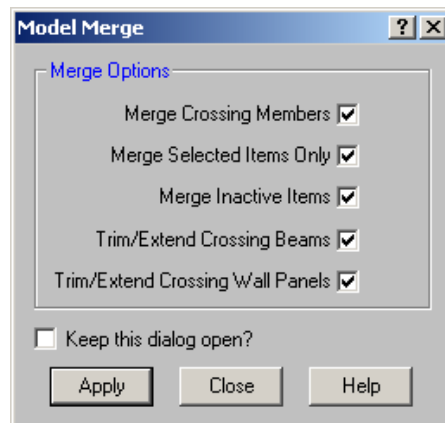
As you build your model, you may find that you will need to perform a model merge from time to time. In fact, if you count on doing this, you can generally build your models faster and let the model merge feature do a lot of the work for you. See [Merge Tolerance](#) to learn about inputting the merge tolerance.



To Perform a Model Merge

1. If there is not a model view already open then click  on the **RISA Toolbar** to open a new view and click  to turn on the **Drawing Toolbar** if it is not already displayed.
2. Select the items you wish to merge. Typically you will want everything to be selected.
3. Click the **Merge**  button and set the parameters for the new merge. Click the Help button for more information.



Trim/Extend Members

As you modify the model, you may find that you will need to trim or extend a member. The Trim/Extend tool will allow you to modify the ends of any member in relation to another member. This extension is for members only, not walls or plates.

Note



- This tool is sensitive to the end that you click. Each member has an I and J end. Make sure to click on the member side that you want to modify.
- You need to click on the member NOT the joint. This tool is modifying the length of the member.

To Perform a Trim

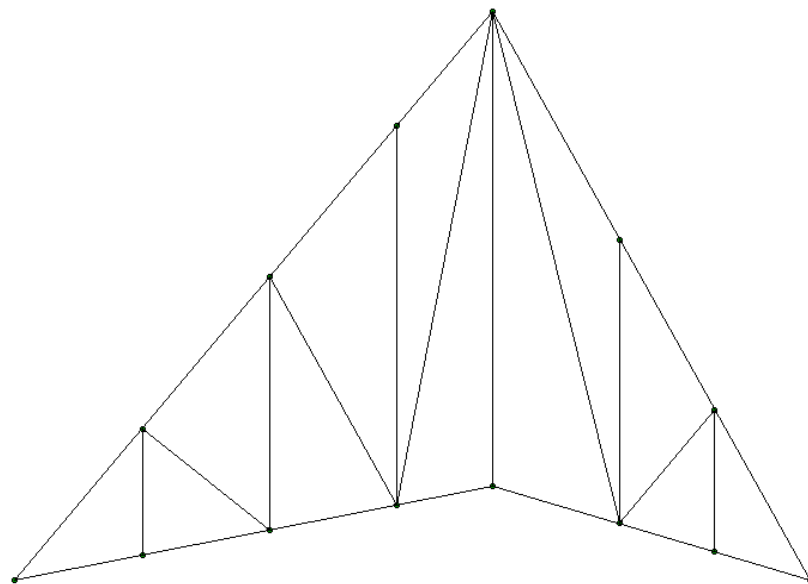
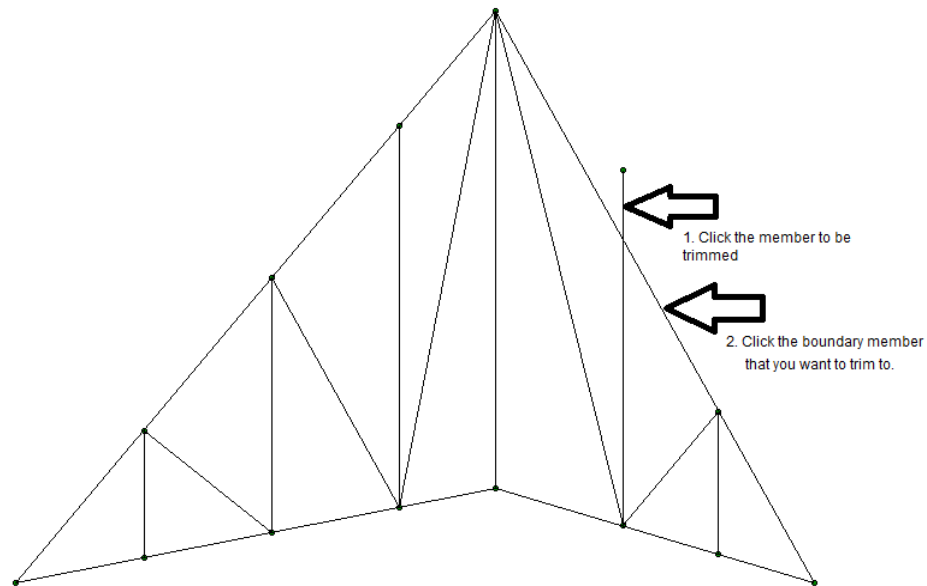
1. If there is not a model view already open then click  on the **RISA Toolbar** to open a new view and click  to turn on the **Drawing Toolbar** if it is not already displayed.
2. Select the items you wish to trim.
3. Click the **Trim**  button.
4. Click on the member end to Trim. Then click on the boundary member.



To Perform an Extend

1. If there is not a model view already open then click  on the **RISA Toolbar** to open a new view and click  to turn on the **Drawing Toolbar** if it is not already displayed.
2. Select the items you wish to merge.

3. Click the **Extend**  button twice or select Extension by clicking the arrow.
4. Click on the member end to Extend. Then click on the boundary member.

Example 1:

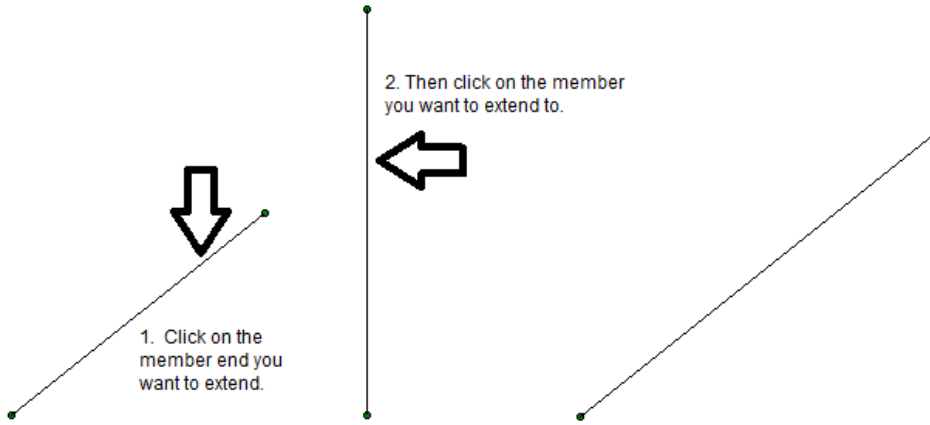

Example 2: The Extend tool can also be used to extend a member to intersection of that member's projected location.

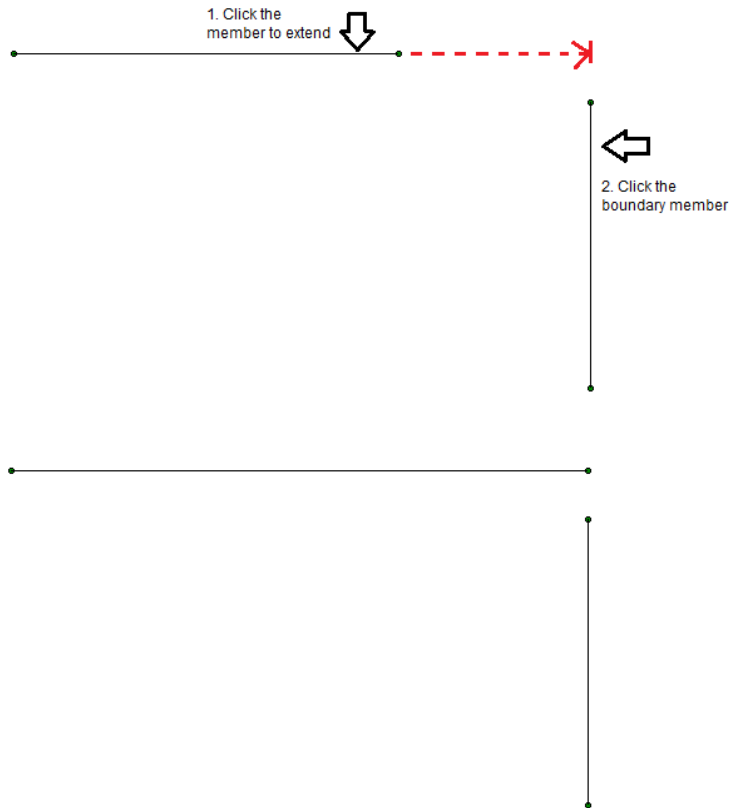

Deleting Elements

You can delete parts of the model based on the current selection state, or you can click on the items you wish to delete individually. If you accidentally delete something you didn't want deleted, you can use the Undo feature to repair the damage.

If you wish to delete based on the current selection state, you must use the check boxes to define the criteria the program will use to perform the deletion. Only items that are selected and that have their check boxes "checked" will be deleted. The choices let you delete joints, members, plates, wall panels, solids and/or loads.

Keep in mind that if you delete joints, any members, plates, etc. attached to the deleted joints **MUST** also be deleted, regardless of whether those elements are selected or not.

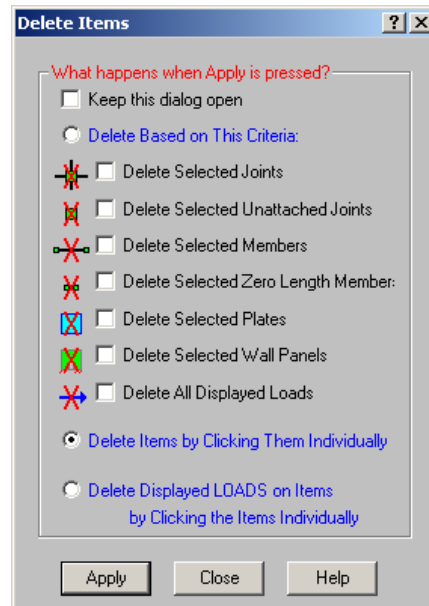

Two noteworthy features are the ability to delete unattached joints and zero length members. Sometimes in the process of modeling you accidentally create unwanted unattached joints or zero length members. These two parameters give you a convenient way to remove these unwanted items.



If you request deletion of displayed loads, you'll get exactly that. Any load currently displayed will be deleted. By controlling what loads are displayed via the **Loads** tab in the **Model Display Options Dialog**, you can easily delete specific types of loads for particular basic load cases, load categories or load combinations.

Alternatively, you can choose to delete items by clicking on them individually. Select the radial button next to **Delete Items by Clicking Them Individually** and use the mouse to click on any individual item you wish deleted.

A final choice is to delete loads individually by clicking on the item the load is applied to. Select **Delete Displayed LOADS on Items** and then click the items (joints, members or plates) whose displayed loads are to be deleted. For example, if you wish to delete certain distributed loads, first use the **Loads** tab in the **Model Display Options** to display the loads to be deleted, then choose the **Delete Displayed LOADS on Items** option and proceed to click on the items to which the loads to be deleted are applied.

Remember to click the **Apply** button to make your choices active.

To Delete Selected Items

1. If there is not a model view already open then click the  button on the **RISA Toolbar** to open a new view and click  to turn on the **Drawing Toolbar** if it is not already displayed.

2. Select the items you want to delete.
3. To delete the items click the **Delete**  and specify the types of items.

Note

- You may undo any mistakes by clicking the Undo  button.

Re-Labeling Selected Elements

You can use the right-click menu in the program to re-label only the selected items. This is useful when you want all members at a certain elevation to have a prefix which denotes the floor on which it is located.

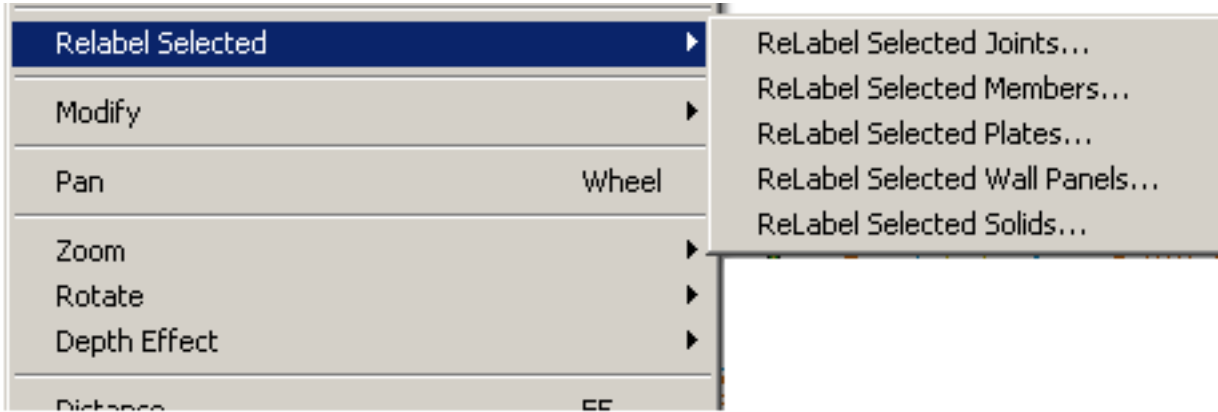

Graphic Selection

You may graphically select items in order to view or modify part of the model or to print part of the results. When used in conjunction with the graphic editing features it allows you to quickly model and make modifications to the model. If used with results it allows you to view and print only the input or results that you want.

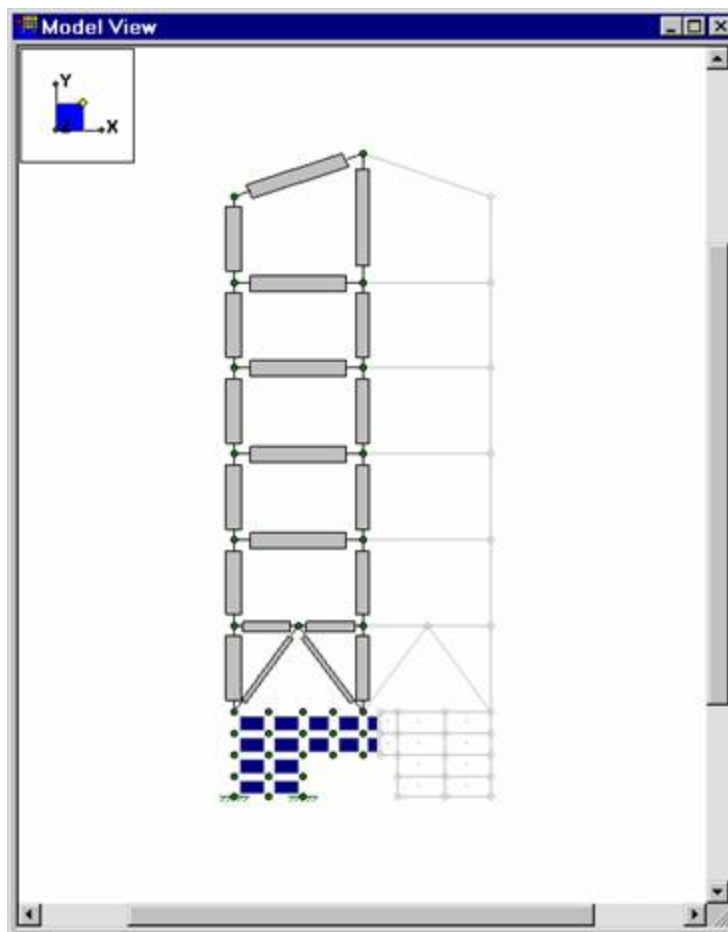

The elements that you see in the model views have two possible states; selected and unselected. By default, all items are selected, and therefore fully displayed. If you unselect any items, they are drawn in a gray or “ghosted” shade. To select or unselect an item simply click on it with the left mouse button. You may also use one of the selection tools below to select multiple items.

Note

- As an alternative to using the selection tools, some operations offer a **Click to Apply** option, which allows you to modify items by clicking or boxing them with the mouse. This is useful when working with a few items.
- Inactive items can only be selected with **Criteria Selection**.
- Unselected items remain as part of the model for the solution. To remove items from the analysis you need to make them inactive.
- If you choose not to display items by turning them off in the **Model Display Options Dialog**, they remain in the current selected state and can still be selected/unselected.

Selection Modes



The **Selection Toolbar** is the vertical toolbar located on the left side of the screen. This toolbar is for selecting joints, members, and plates in model views. This toolbar will not be available when a model view is not active. You may also access the selection tools from the **View Menu**.

Some of the tools are for one-time applications such as **Select All**. Other tools, such as **Box Select**, place you in a selection mode that remains active until you cancel it. The current mode is indicated by the mouse pointer and by the state of the button. While in a selection mode the button will stay depressed until you click it again, choose another button, or press the ESC key. You may have more than one model view open and may be in different modes in each view.



Note

- There are other types of graphic modes such as **editing** and **viewing** (zooming) modes. The viewing mode overrides the selection mode, which overrides the editing mode. This is so that while you are editing the model you can alter the selected state. You will be returned to the current editing mode when you terminate a selection mode.
- To cancel a selection mode re-click the same button so that it is in the "up" position, or press the ESC key, or click the right mouse button.
- You can cancel a box, line, or polygon selection that is underway by dragging the mouse off the model view while still holding the mouse button down.



Select All and Unselect All

Clicking **Select All**  and **Unselect All**  tools will select or unselect all of the active joints, members, and plates in the model.



Box Select and Unselect Modes

The **Box Select**  and **Box Unselect**  tools allow you to draw a box around the items that you wish to select or unselect. Members and plates must be entirely within the box in order for them to be affected.

Polygon Select and Unselect

The **Polygon Select**  and **Polygon Unselect**  tools allow you to draw a polygon around the items that you wish to select or unselect. Members and plates must be entirely within the polygon in order for them to be affected.

Line Select and Unselect

The **Line Select**  and **Line Unselect**  tools allow you to draw a line through the items that you wish to select or unselect. Any element the line crosses will be affected. This is useful when choosing items between other items such as columns between floors.

Inverting Selections

The **Invert Selection**  button is used to invert the selected state of the model. When clicked, all selected items are made unselected and all previously unselected items are made selected. For example, this can be very

useful when just a few items are to be selected in a large model. Simply click on the desired items to unselect them, then click the **Invert Selection** button to make them selected and everything else unselected.

Criteria Selections

The **Criteria Selection**  button allows you to select items based on a wide range of criteria such as coordinates, labels and many other conditions. When the **Criteria Select** button is clicked, you will be presented with the Criteria Selection Dialog with options grouped by tabs across the top. Each tab represents groups of criteria that you may use to refine your selection.

The options are numerous making it easy to quickly achieve complicated selections. This is a powerful tool so it is worth taking the time to experiment with the options so that you will know how to use it to your advantage. The various tabs in the dialog are described below.

Joints

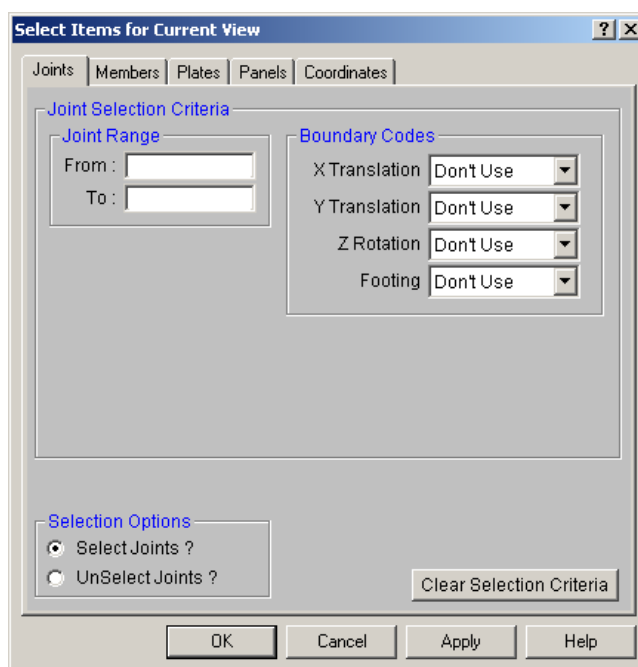

You may **Select** or **Unselect** joints as follows.

Joint Range – You may specify a range of joint labels. Specifying only one label selects just that one joint .

Boundary Codes – You may specify boundary condition criteria in all three degrees of freedom.

Note

- If no criteria are specified, all the joints will be selected/unselected.

Members

You may **Select** or **Unselect** members based on the following criteria.

Member Range – You may specify a range of member labels. If only one label is entered, only that one member will be selected.

Parallel – You may select members that are parallel to a certain member, whose label you enter, or parallel to a global axis.

Member Section Properties – You may specify a Section Set, Database Shape and Material to be applied when selecting members.

Misc – You may select members that are currently inactive. Using this criteria will make these members active. To make them inactive once again you can then use **Modify Members**. You may select members that are tension only and compression only members as well as Physical members. Members with the Top of Member flag set can also be quickly found.

Note

- If no criteria are specified, all the members will be selected/unselected.

Plates

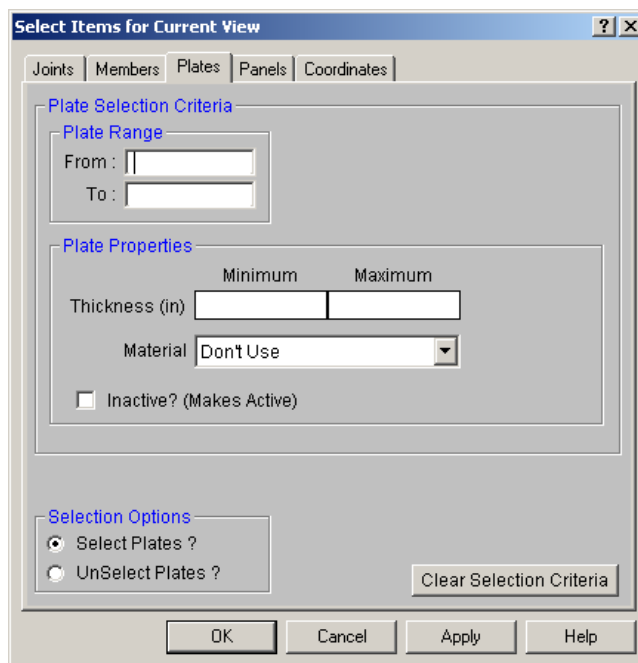

You may **Select** or **Unselect** plates based on the following criteria.

Plate Range – You may specify a range of plate labels. If only one label is entered, only that one plate will be selected.

Parallel – You may select plates that are parallel to certain plate, whose label you enter, or parallel to a global plane.

Plate Properties – You may specify a minimum and maximum Thickness and Material to be applied when selecting plates. You may also select only the [plane stress](#) plates. You also may select plates that are currently inactive. Using this criterion will make these plates active. To make them inactive once again you can then use **Modify Plates**.

Note

- If no criteria are specified, all the plates will be selected/unselected.

Wall Panels

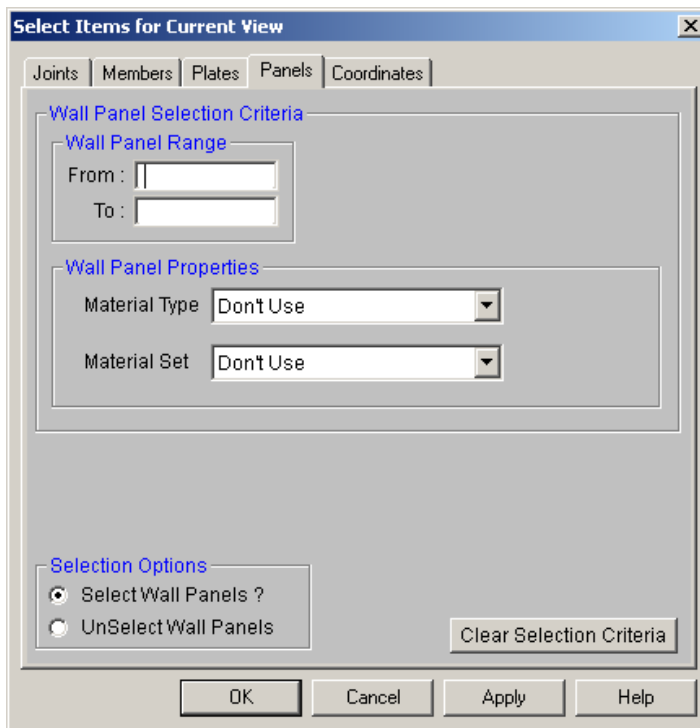

You may **Select** or **Unselect** panels based on the following criteria.

Wall Panel Range – You may specify a range of panel labels. If only one label is entered, only that one panel will be selected.

Parallel – You may select panels that are parallel to certain panel, whose label you enter, or parallel to a global plane.

Wall Panel Properties – You may specify a Material Type (Wood, Masonry, etc) and/or Material Set (Larch, Clay, etc). You also may select panels that are currently inactive. Using this criterion will make these panels active. To make them inactive once again you can then use **ModifyPanels**.

Note

Coordinates

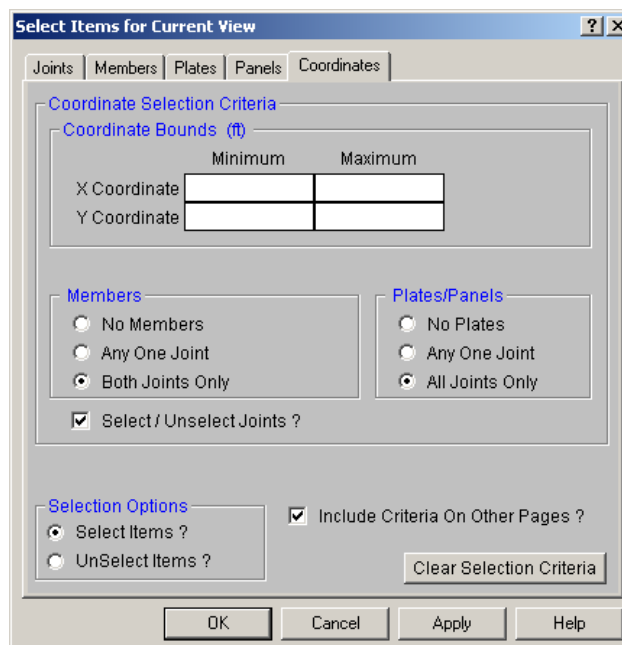

You may select or unselect elements based on coordinate criteria and combine this with the criteria on the other tabs.

Coordinate Bounds – You may specify minimum and maximum bounds in the global directions. Items within these bounds AND meeting the criteria in the other groups will be selected/unselected.

Member Criteria – You may specify that one or both member end joints be within the bounds. You may also specify that no members be selected within the range.

Plate/Panel Criteria – You may specify that one or all plate corner joints be within the bounds. You may also specify that no plates be selected within the range.

Select/Unselect Joints – You may specify that joints in the coordinate range be selected or not.

Include Criteria On Other Pages – This option allows you to include selection criteria from the other pages (Joints, Members, Plates) and combine it with the coordinate range specified on this page.

Note

- If the “Include Criteria On Other Pages” option is selected, all criteria will be applied together so that the affected items will meet all of the criteria. For example if you specify a range of joint labels and coordinates, only the joints within the coordinate bounds and within the label range will be selected/unselected.

Lock & Dim Lock

Click the **Lock Unselected**  button to cause all currently unselected items to stay unselected and be visually removed from the current model view. This is useful when you are editing or printing a portion of a model and need to clear the model view of all items not involved.

To Unlock the unselected members in the model view, click the **Unlock Unselected**  button and the unselected items that were previously "removed" from the model view will be returned to the view in the unselected state.

Viewer Mode

Similar to the **Dim Lock** feature, clicking the Viewer Mode eye icon  will cause all currently unselected elements to become greyed out. However, in viewer mode, you can select or unselect elements with a single click.

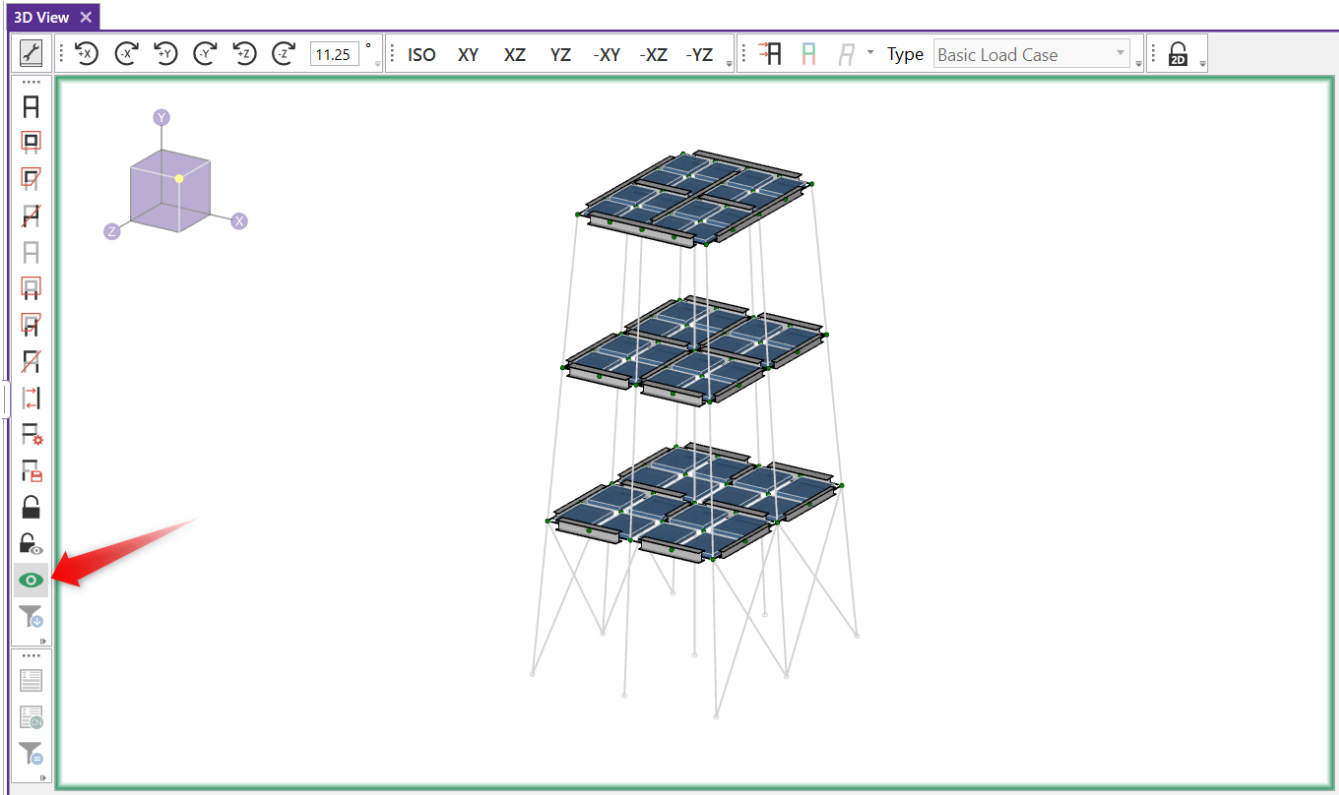

While in viewer mode, labels, results and other element specific information will only be displayed for elements that are selected. You can quickly click on different elements to make them visible or grayed out.

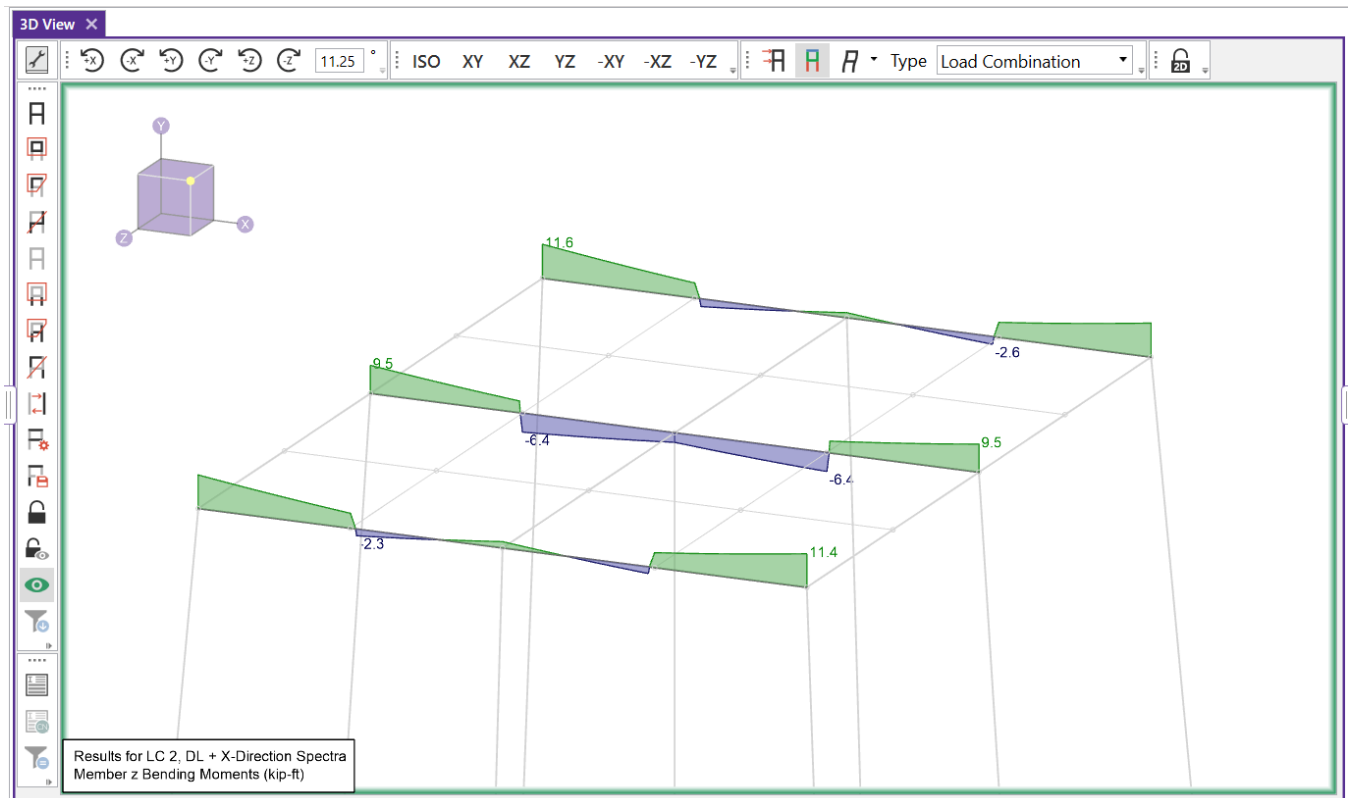

In addition to the graphic display, both the input and result spreadsheets will automatically filter its information based on the elements that are selected in the viewer mode. This automatic filtering can be turned off within your Application settings > General tab.

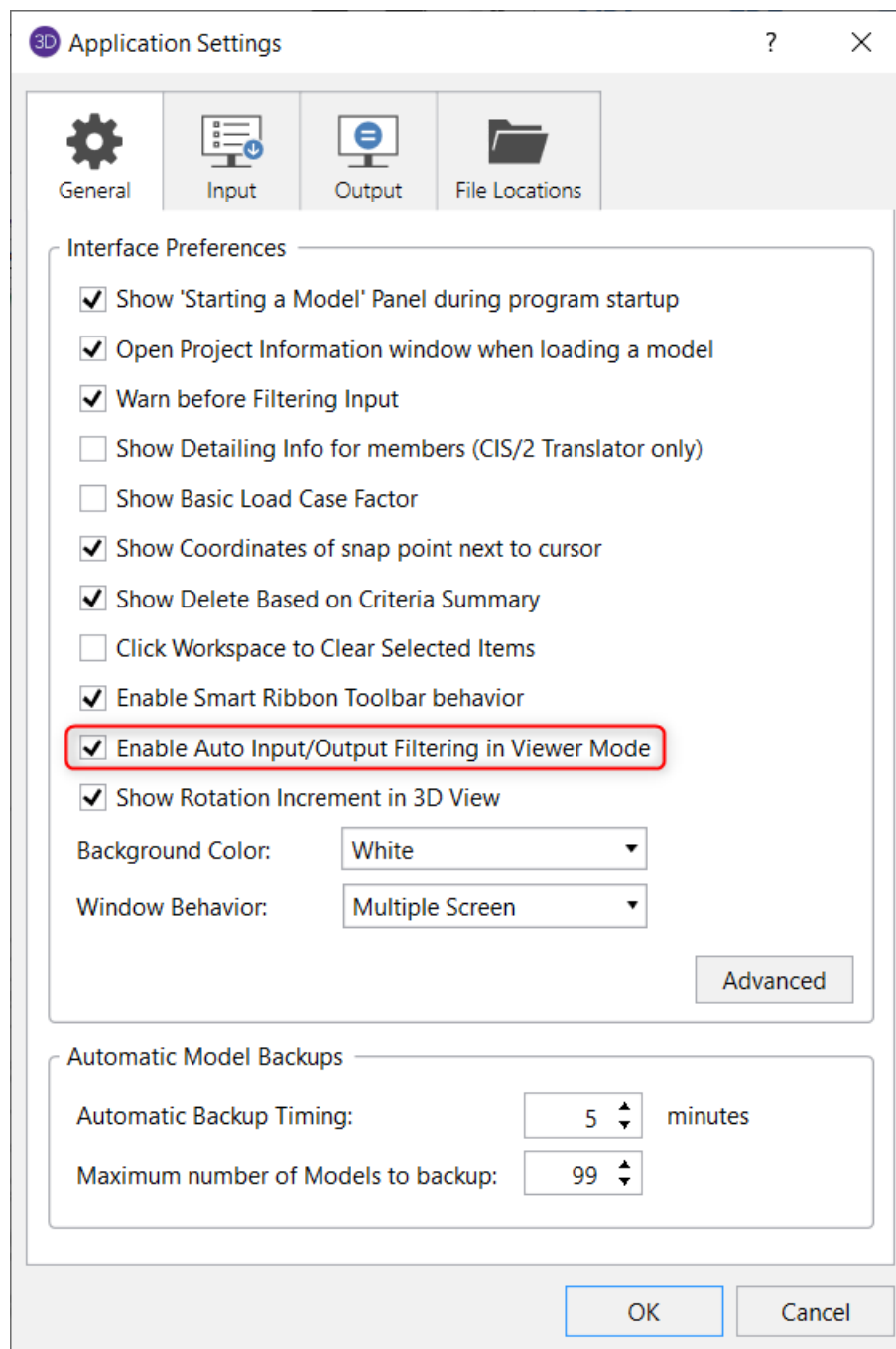

Note that while in viewer mode you will see a green border around the 3D view.

It is also important to note that while in viewer mode, it is not possible to model or make edits to your model. The intention behind this is that viewer mode is primarily focused on 'viewing' your elements and associated element information.

Graphic Selection from Spreadsheets

In many spreadsheets, both Data Entry and Results, you can select rows on the spreadsheet and use the right-click menu to select the **Select Marked Lines in Current View** or **Unselect Marked Lines in the Current View** options. This will graphically select or unselect the items corresponding to the selected rows in the top most model view window. This is very useful for highlighting failing members in a spreadsheet and then having them graphically selected in a model view to see where the problems are.

Saving Selections

You can save and recall various selection states for a model. If the model is altered after a selection state has been saved, the saved selection state will also be altered. Any new items (joints, members...) will be set to "selected" in any selection states saved prior to the creation of the new item.

To save a selection state, click the **Save Selection State**  button on the **Selection Toolbar**.

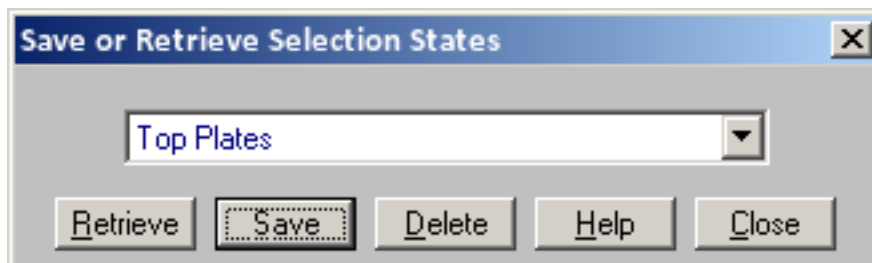

Click the **Save** button and provide a name for the saved selection. You can have up to 16 different saved selections in a model. To retrieve a saved selection, choose the selection state from the drop down list and click the **Retrieve** button. To delete a saved selection, choose the selection state from the drop down list and click the **Delete** button.

Help Options

RISA Tech, Inc. has, and will, put a great deal of effort into assisting you in getting your work done as quickly as possible. This includes providing many ways that you can get help in understanding the software.

Electronic Help File

The **Help File** is designed to help you get your work done as quickly as possible and is intended to provide:

- Procedures that lead users through the steps of completing tasks
- Context-sensitive Help topics that provide users with quick descriptions of items on their screens
- Troubleshooting topics that guide users through solutions to common problems
- Extensive discussions for a thorough understanding of engineering and modeling topics
- Easy access to related topics

The electronic help file can be accessed by clicking the **Help File**  button on the **RISA Toolbar**. A new window containing a Table of Contents will be opened. Click on any item in the Table of Contents for extensive information on the topic.

Context Sensitive Help

Context Sensitive Help is help that a user can access in context while working in a program. It provides you with the information you need where and when you want it.

You may get detailed help when working in a dialog, spreadsheet or graphic view by pressing **F1**. This will launch a Help File window displaying the topic that is related to the window in which you are working. The topic will be explained and links to related topics may also be provided.

RISA Tech, Inc. Online

Our website, www.risa.com, provides various support information and documents.

Visit RISA Tech, Inc. on the web for:

- Download program [Manuals](#) (General Reference or Tutorial)
- Check our website for the latest [updates](#) - When a bug is discovered it is posted on the web site along with possible work-around procedures and/or service releases to update your software.
- Software [Verification Problems](#)

Tool-tips

Are you uncertain what a toolbar button is for? Simply hold your mouse pointer over that button without clicking. **Tool-tips** are displayed that will explain what the button will do should you decide to press it.

Tutorials

The comprehensive **Tutorials** guide you through using most features. It is a real-world example of building and solving a model, making changes, and optimizing. This is the best way to quickly get up and running. The [Tutorials](#) are designed to be read in two ways. If you are already familiar with structural modeling in general you can skip the supporting text and read only the underlined action items to quickly move through the tutorial. If you want more thorough explanations of the modeling process you may read all or some of the supporting text as you see fit.

Hot Rolled Steel - Databases

Shapes are organized by **Shape Type** and **Database / Manufacturer**. Common shapes are supported such as wide flanges, tubes, pipes, channels, etc. You may type in the names directly, select shapes from these databases or add your own shapes.

RISA currently supports the following common Hot Rolled steel databases: AISC (United States), Australian, British, Canadian, Chilean, Chinese, European, Indian, and Mexican.

Note:

- Older AISC shapes which are no longer part of the AISC database will be automatically moved / exported to a new AISC_backup database during installation or update.

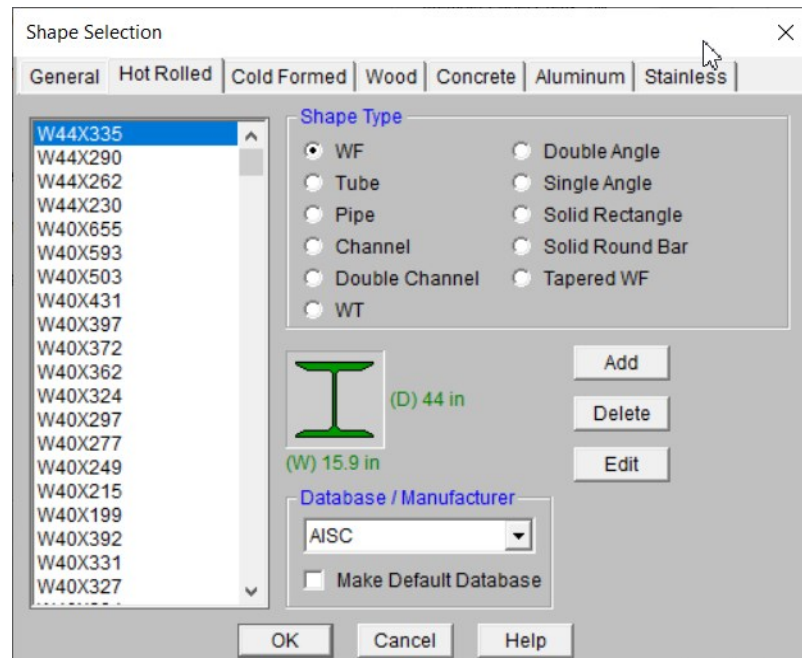

To Select a Hot Rolled Database Shape

1. From the **Hot Rolled** tab on the **Section Sets Spreadsheet**, or the **Primary** tab of the **Members Spreadsheet**, move the cursor to the **Shape** field and click .
2. Specify the database and shape type you wish to use and then select from the list of available shapes by clicking on .

To Add a Database Shape

1. On the **RISA Toolbar** click the **Edit Shape Database**  button.
2. Select the **Hot Rolled** tab, then specify the database and shape type you wish to add and click the **Add** button.
3. Specify a name for the shape and fill in the **Basic Properties**.
4. Click **Calc Props** to determine the shape properties.

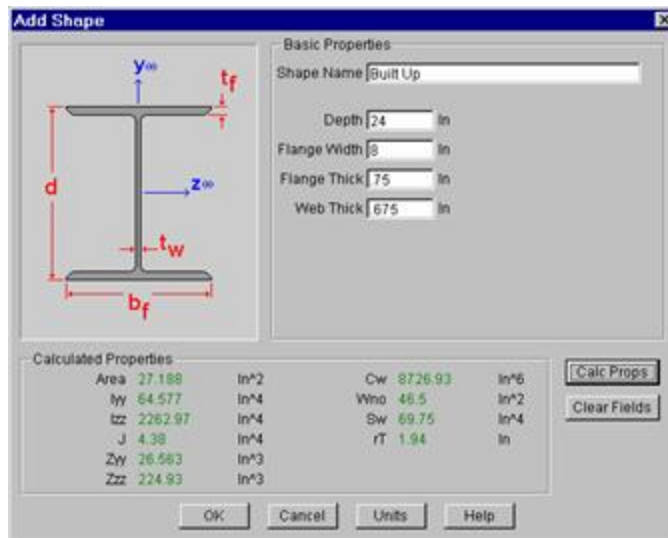

Note

- Alterations to the shape database are not permanent unless you agree to save them. Changes that are not saved only remain valid for the current session and will not be present the next time you start RISA.
- New shapes are added to the bottom of the database.
- To delete a shape, specify the database and shape type you wish to delete and then click the **Delete** button.
- To edit a shape, click the **Edit** button and edit the shape properties. Values can only be manually edited here, nothing will be recalculated. If you wish to have all the values for a shape recalculated, you will need to delete the shape and then add it again with the new properties.

Wide Flange Database Shapes

For the AISC database, wide flange shapes are called out by the designation given them in the steel manuals. For example, if you wanted to use a W10x33 you would enter W10X33 as the shape name in the database shape field. M, S and HP shapes are also available. Trade Arbed shapes are called out similar to AISC shapes but with a "_ARB" suffix. I.e. to call a Trade Arbed W12X96 would enter W12X96_ARB as the shape name in the database shape field. Canadian and British shapes use the same format as the AISC shapes, but their values are metric. The depth is called out in millimeters and the mass per length is kg/meter.

Tube Database Shapes(Hollow Rectangular shapes)

The HSS tube properties are also available in the AISC database. The prefix for these tube shapes is "HSS". The syntax is "HSSdepthXwidthXthick", where "depth" is the tube depth, "width" is the tube width and "thick" is the tube thickness in number of 1/16ths. The nominal wall thickness is always used to call out a HSS tube, even though the design wall thickness will vary based on the manufacturing process for the tube. Tubes manufactured using the ERW process will use .93 times the nominal wall thickness as their design thickness. Tubes manufactured using the SAW process will use the full nominal thickness as their design thickness. For example, an HSS12X10X8 would be a 12" deep, 10" wide tube, and have a design wall thickness of $.465" = .93 \times 1/2"$ (8/16ths) . A HSS32X24X10 would be 32" deep by 24" wide, and have a design wall thickness of $5/8"$ (10/16ths)

For the Canadian database, tubes also have a "HSS" prefix and the dimensions are all called out in millimeters. British shapes use the prefix "SHS" for square tubes and "RHS" for rectangular tubes.

Note:

- The prefix for older AISC tube shapes is "TU". These shapes reflect the properties that were published with the older AISC 9th edition. As such, these shapes may only exist in the AISC_backup database.
- Tubes using the TU prefix will have a design wall thickness of the nominal wall thickness. The syntax is "TUdepthXwidthXthick", where "depth" is the tube depth, "width" is the tube width and "thick" is the tube thickness in number of 1/16ths. For example, TU16X12X8 would be a 16" deep, 12" wide tube with a thickness of 1/2" (8/16ths).

Pipe Database Shapes

Pipe shapes, which are hollow circular shapes, are entered as on-line shapes. The syntax for these shapes is "PIdiaXthick", where "dia" is the pipe outside diameter and "thick" is the pipe thickness (in inches or centimeters). For example (assuming US Standard units), PI10X.5 would be a 10" diameter pipe with a wall thickness of 1/2".

Channel Database Shapes

Channel shapes are entered with the "C" or "MC" prefix. For example C15X50 would be a valid entry. For Canadian and British shapes, the depth is called out in millimeters and the mass per length is in kg/meter. Double channels are entered with the "2C" or "2MC" prefix.

Tee Database Shapes

The Tee shapes are entered with the "WT", "MT" or "ST" prefix. For example WT15X74 would be a valid entry. For Canadian and British shapes, the depth is called out in millimeters and the mass per length is in kg/meters.

Tapered Wide Flange Shapes

Tapered Wide Flange shapes are called out by referring to the shape name that was given when it was defined in the database shape editor. Tapered WF shapes can only be defined as database shapes using the "ADD" shape function in the database editor.

Tapered WF shapes are special in that the cross sectional properties change along the length of the member. This is as opposed to prismatic members, which have the same cross sectional properties along their length. (All other shapes are prismatic members). Keep this in mind when defining the I and J joints for tapered shapes. To obtain alternate tapered shape suggestions it is best to define all Tapered WF members consistently in the shape database and handle orientation with the I and J joints.

The Tapered WF shape can also be used to define a prismatic WF with unequal flanges. Tapered wide flange shapes can taper all cross section properties independently and can also have unequal top and bottom flanges. Each basic property is assumed to taper linearly from the Start value to the End value. Shape properties like the area and the moments of inertia will be computed at any required intermediate point from the linearly interpolated basic properties. (This means that the area and moments of inertia will probably NOT vary linearly along the member length). Intermediate shape properties are used to calculate the member stiffness and stresses. The member stiffness is computed internally from a series of piecewise prismatic sections. The error in the member stiffness computed in this manner, as opposed to the theoretically "correct" stiffness, is always less than 10%.

Note that tapered members are always treated as physical members – not finite members. All the rules and behaviors described for physical members always apply to tapered members even if the physical member flag is not set for those members. See [Physical Members](#) to learn more about this feature.

To Add a Tapered Wide Flange to the Database

- To enter a tapered shape in the database click  , select the Tapered WF Shape Type and click **Add**. Enter the basic shape properties at the Start and End locations and to have all the necessary parameters calculated for analysis and design at the member end points and at all the required intermediate locations.

Note

- To enter a prismatic WF member with unequal top and bottom flanges, just make sure that the shape properties are the same at the Start and End points. The top and bottom flange information is entered independently.

Double Angle Database Shapes

These shapes are entered with the prefix "LL". The syntax is "LLbackXflangeXthickXspace" where "back" is the back to back leg length, "flange" is the single angle flange leg length, "thick" is the angle thickness in number of 1/16ths and "space" is the space between the angles in 1/8ths. For example, **LL6X3.5X5X3** would be L6X3.5 angles 5/16" thick, long legs back to back with a spacing of 3/8". For the Canadian and British shapes, all the dimensions are called out in millimeters.

Single Angle Database Shapes

Angles are entered with an "L" prefix. The syntax is "LlongXshortXthick", where "long" is the long leg length, "short" is the short leg length, and "thick" is the thickness, in number of 1/16ths. For example, L9X4X8 is a 9" by 4" angle 1/2" (8/16ths) thick. The thickness is entered as 8, because the number of 1/16ths in 1/2 is 8. For the Canadian and British shapes, all the dimensions are called out in millimeters.

Note:

- **rZ** is the Radius of Gyration along the rotated (Principal) vertical axis (local y). The Canadian CSA code calls this variable ry' but RISA calls it rZ based on the naming convention of the AISC 360.

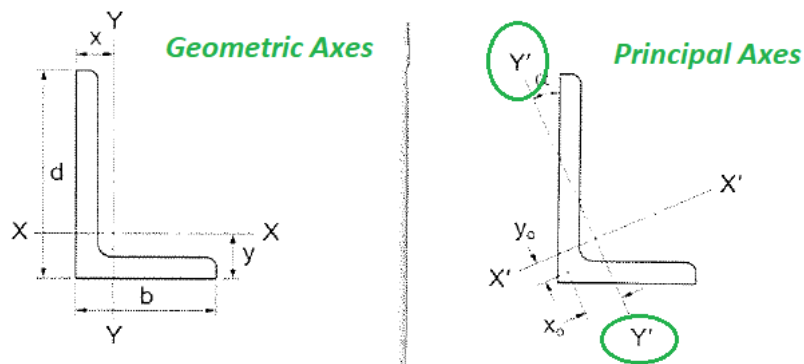
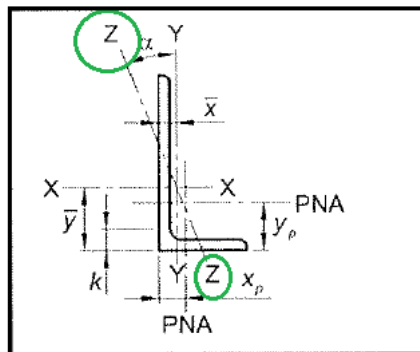
Per CSA S16-16 (11th edition):**Per AISC 360-16 (15th edition):****Solid Rectangular Shapes**

These shapes can be defined as on-line shapes. The syntax is "REhtXbase", where "ht" is the rectangle height and "base" is the rectangle base (in inches or cm). For example, RE10X4 would be a 10" deep, 4" width rectangular shape (assuming US Standard units). These shapes can also be defined in the Shape Editor. When defined in the Shape Editor the depth of the solid rectangular section must always be greater than or equal to the width.

Solid Circular Shapes

These shapes are defined as on-line shapes. The syntax is "BARdia", where "dia" is the circle diameter. For example (assuming metric units), BAR2 would be a circular bar with a diameter of 2 cm.

Buckling-Restrained Brace Database Shapes

Buckling-restrained brace (BRB) shapes are only available in RISAFloor-RISA3D integration models. They can be selected by choosing the BRB shape type and one of the BRB-related databases. Currently, only CoreBrace database is supported.

When CoreBrace database is chosen, the syntax for CoreBrace BRB shapes is "CoreBRB_area", where "CoreBRB" is the prefix for the manufacturer and shape, and "area" is the steel core area. For example, CoreBRB_0.50 refers to a BRB shape manufactured by CoreBrace with a 0.50 in² steel core area. Other properties such as the casing size of the brace are based on the data provided by the manufacturers.

BRBs are not prefabricated with specific core sizes, casing sizes, or brace lengths. Instead, they are custom-fabricated for each project. Therefore the BRB properties in RISA-3D may not be the final and shall be carefully reviewed by BRB manufacturers.

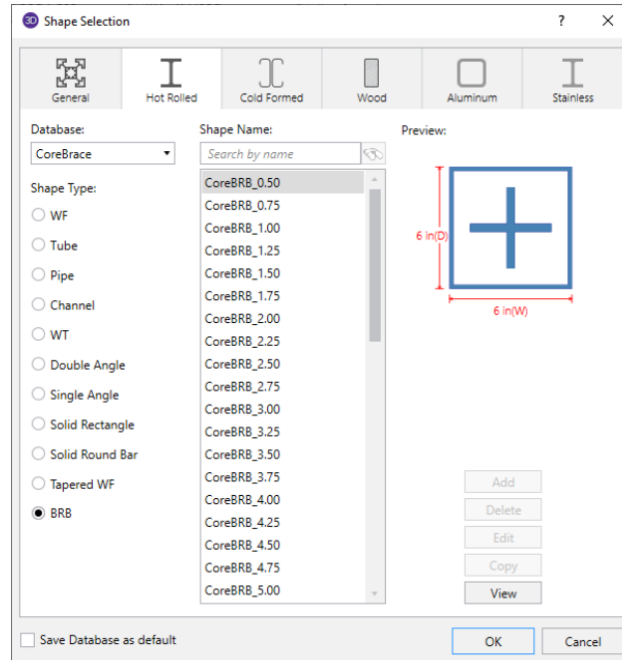
**Note:**

- The BRB shape database is only available for RISAFloor/RISA-3D integration models.

Hot Rolled Steel - Design

Full code checking member optimization can be applied to standard steel shapes based on the following codes:

- United States:
 - AISC 360-16 (15th Edition) ASD & LRFD
 - AISC 360-10 (14th Edition) ASD & LRFD
 - AISC 360-05 (13th Edition) ASD & LRFD
 - AISC LRFD (2nd and 3rd Editions)
 - AISC ASD (9th Edition)
- Canada:
 - CSA S16-14
 - CSA S16-09
 - CSA S16-05
 - CSA S16-01
 - CSA S16.1-94
- Europe/Great Britain:
 - EN 1993-1-1: 2014 (including the U.K. National Annex provisions)
 - EN 1993-1-1: 2005 (including the U.K. National Annex provisions)
 - ENV 1993-1-1: 1992
 - BS 5950-1: 2000
- India:
 - IS 800: 2007
 - IS 800: 1998
- Australia:
 - AS 4100-1998
- New Zealand:
 - NZS 3404: 1997

The calculations performed encompass all the code requirements (including the local buckling criteria for slender compression elements in Appendix B of the 2nd, 3rd, and 9th Edition AISC codes) except those noted in the *Limitations* section of this document

How To Apply a Steel Design Code

1. On the **Model Settings - Codes** tab, select the steel code from the drop down list.

2. On the **Hot Rolled** tab of the **Members Spreadsheet**, enter the appropriate bracing information and factors.

Note:

- For code checking to be performed on a member, the member must be defined with a database shape on the **Section Sets** or **Members Spreadsheet**.

Design Parameters Spreadsheet

The **Hot Rolled Steel Design Parameters** Spreadsheet records the design parameters for the steel code checks and may be accessed by selecting **Members** on the **Spreadsheets** menu and then selecting the **Hot Rolled** tab. These parameters are defined for each individual member and may also be assigned graphically. See [Modifying Member Design](#) to learn how to do this.

20 Hot Rolled Steel Design Parameters														
		Primary	Advanced	Hot Rolled	Cold Formed	Wood	Concrete Beam	Concrete Column	Aluminum					
	Label	Shape	Length...	Lb-out[ft]	Lb-in[ft]	Lcomp top[ft]	Lcomp bot[ft]	K-out	K-in	Cm	Cb	Out sway	In sway	Function
1	M1	HR1A	8	Segment	Segment	1.5		1	.65			<input type="checkbox"/>	<input type="checkbox"/>	Lateral
2	M2	HR1A	8	4	4			1	.65			<input type="checkbox"/>	<input type="checkbox"/>	Lateral
3	M3	HR2	11	Segment				1	1			<input type="checkbox"/>	<input type="checkbox"/>	Lateral
4	M4	HR2	10					1	1			<input type="checkbox"/>	<input type="checkbox"/>	Lateral
5	M5	TAPER_FLAN	13.601					1	1			<input type="checkbox"/>	<input type="checkbox"/>	Lateral

The following topics will discuss the steel design parameters by first discussing how it applies to regular prismatic steel sections. If the parameter is treated differently for Tapered WF shapes, that will be discussed separately in the [Tapered Members](#) section.

Label

You may assign a unique **Label** to all of the members. Each label must be unique, so if you try to enter the same label more than once you will get an error message. You may relabel at any time with the **Relabel** options on the **Tools** menu.

Shape

The member **Shape** or Section Set is reported in the second column. This value is listed for reference only and may not be edited as it is dictated by the entry in the **Section/Shape** column on the **Primary** tab.

Length

The member **Length** is reported in the third column. This value may not be edited as it is dependent on the member end coordinates listed on the **Primary Data** tab. It is listed here as a reference for unbraced lengths which are discussed in the next section.

Member Design Parameters - General

Unbraced Lengths

See the [Unbraced Lengths](#) topic.

K Factors (Effective Length Factors)

See the [Unbraced Lengths](#) topic.

Sway Flags

See the [Unbraced Lengths](#) topic.

AISC Design Codes - Member Design Parameters

C_m - Interactive Bending Coefficient

C_m Coefficients are described in Chapter H of the 9th Edition AISC (ASD) code. If these entries are left blank, they will be automatically calculated.

The **C_m** value is influenced by the sway condition of the member and is dependent on the member's end moments, which will change from one load combination to the next, so it may be a good idea to leave these entries blank.

Note

- The **C_m** factor is not used for LRFD code checking because the Chapter C requirement that P-Delta effects be considered is met with a direct P-Delta analysis. LRFD code checks will not be performed without P-Delta analysis.

C_b - Lateral-Torsional Buckling Modification Factor

C_b Factors are described in Chapter F of the AISC code and are used in the calculation of the nominal flexural strength, **M_n**. If this entry is left blank, it will be calculated automatically for AISC code checks.

The calculation of **C_b** is based on the unbraced length of the compression flange and the moment diagram for the unbraced segment in question. If a specific unbraced length is entered by the user, the program cannot interpret the location of brace points and the **C_b** value will default to '1.0'. In some cases, it may be better to enter 'segment' as the unbraced length for a physical member. When 'segment' is entered, the **C_b** value will be calculated individually for each segment of the beam based on that segment's moment diagram.

Notes:

- For members designated as "Tapered WF" shapes, **C_b** is always calculated per the AISC 360 section F1 equation.

- AISC 9th Ed always assumes $C_b = 1.0$.

Function for Stiffness Reduction

The **Function** entry may be set to either 'Lateral' or 'Gravity' using the drop down list in the spreadsheet. If the Adjust Stiffness option is set to Yes on the Codes tab of the Model Settings Dialog, then all members with a 'Lateral' Function will be considered for the stiffness reduction required per the AISC Direct Analysis Method.

The **Flexural Stiffness Reduction** of the Direct Analysis Method will be applied to all 'Lateral' members.

The program can perform an iterative analysis during the solution depending on the value of τ_b . In this case, the stiffness matrix is recomputed for each iteration until the value of τ_b converges within 1 percent for all 'Lateral' members in compression. In the unlikely event that τ_b is less than zero, the value of τ_b is considered to be 1.e-5. When used in the analysis, the value for τ_b will be listed in the Detail Report for that member.

When the users sets the Adjust Stiffness flag on the (Global) [Model Settings](#) to **Yes (Tau =1.0)**, then the program will use a Tau of 1.0 in the stiffness analysis and no iteration of the stiffness matrix is necessary. This option is a good feature for models which take a long time to solve or which have not yet been proportioned to control drift.

The **Axial Stiffness Reduction** of the Direct Analysis Method behaves differently. For the AISC 360-05, 360-10, and 360-16, the reduction will be applied to all 'Lateral' members.

Note

- The stiffness reduction required by the Direct Analysis Method will be ignored if the Adjust Stiffness option is not selected on the [codes](#) tab of the **Model Settings**, or if the design code chosen does not have an option for stiffness reduction.
- The Direct Analysis Method requires the use of reduced flexural stiffness for all members whose flexural stiffness is considered to contribute to the lateral stability of the structure. This will only apply to members designated as type 'Column' or 'Beam.' If the user assigns type 'None' to the member, the Flexural Stiffness Reduction will not be applied.
- When the Adjust Stiffness flag is set to **Yes (Tau=1.0)**, then the code would requires a higher value for the applied Notional Loads.

Channel Conn.

The type of connection for double channels is reported in the Channel Conn. column. This input is only for back to back channels and is used in the calculation of KL/r .

a - Connector Spacing

For double channels, the connector spacing 'a' is used in the calculation of KL/r . This input is only used for back to back channels.

Allowable Stress Increase Factor (ASIF)

AISC 9th Edition

Increasing of allowable stresses may be allowed when forces are transient. You may enter an **ASIF** factor on the **Load Combinations Spreadsheet** to allow the increase for a specific load combination. The ASIF factor is then applied to the allowable stresses in accordance with section A5. The ASIF factor also is applied to the Euler values ($F'e$).

Note

- If the allowable stress increase is being used, the final code check value should still be compared to '1.0'.

All Other US Codes

Setting the **ASIF** factor to a value greater than '1.0' will not cause the capacities to be increased by that factor. However, setting the **ASIF** factor to a value greater than '1.0' is used as a flag to use of the seismic compactness criteria of Table I-8-1 of AISC 341-05 Seismic Provisions of Steel Buildings. Specifically we will use the limiting width-thickness ratios from this table for capacity calculations (for compression flange local buckling for example). In these cases, we use Table I-8-1 of AISC 341-05 as opposed to Table B4.1 of AISC 360-05.

AISC Design Codes - Limitations

AISC 360-16 (15th Ed.)

Wide Flanges:

- Flexural torsional buckling per Chapter E is included when L_{torque} is greater than either L_{byy} or L_{bzz} .
- Flange local buckling per Chapter F is only included when the web is compact and the flange is either non-compact or slender.

Rectangular Tubes - Lateral torsional buckling is checked per section F7.4, however this section only applies to strong axis bending.

Code Checks - For combined bending and tension (Section H1.2) the code-allowed modification of C_b is not applied. For combined bending and compression, Section H1.3 is not considered, meaning that the program can be over conservative in some situations.

Single Angles - Single angles in compression are not checked for Section E4 because no standard single angle shapes have a slenderness $(b/t) > 20$. They are also not checked for Section E5 as there is insufficient information regarding the connections and usage of the member.

WT and LL Shapes - This code does not address the rare case where Lateral Torsional (or Flexural Torsional) Buckling occurs for WT's and double angles bent about their weak axis. Therefore, only yielding is checked for weak axis bending.

Double Channels - Double channel connector spacing requirements are not checked. Additionally, double channel design is only available in AISC 360-16 and AISC 360-10 codes.

AISC 360-05 (13th Ed.) and AISC 360-10 (14th Ed.)

Wide Flanges:

- For AISC 360-10, flexural torsional buckling per Chapter E is included when L_{torque} is greater than either L_{byy} or L_{bzz} .
- For AISC 360-05, flexural torsional buckling per Chapter E is only included when $L_{torque} > L_{byy}$ and $L_{torque} > L_{bzz}$.
- Flange local buckling per Chapter F is only included when the web is compact and the flange is either non-compact or slender.

Code Checks - For combined bending and tension (Section H1.2) the code-allowed modification of C_b is not applied. For combined bending and compression, Section H1.3 is not considered, meaning that the program can be over conservative in some situations.

Single Angles - Single angles in compression are not checked for Section E4 because no standard single angle shapes have a slenderness $(b/t) > 20$. They are also not checked for Section E5 as there is insufficient information regarding the connections and usage of the member.

WT and LL Shapes:

- This code does not address the rare case where Lateral Torsional (or Flexural Torsional) Buckling occurs for WT's and double angles bent about their weak axis. Therefore, only yielding is checked for weak axis bending.
- For slender WT sections, the compressive capacity is calculated with Q_a always assumed equal to 1.0.

ASD 9th Edition Limitations

Wide Flange Shapes - Code checks for shapes that qualify as plate girders, as defined by Chapter G, are not performed. Plate girders that can be checked by the provisions of Chapter F will have code checks calculated.

Channels - The AISC 9th Edition (ASD) specification does not specifically address the allowable stress for weak axis bending of channels. Therefore, the program uses the most similar formula for the weak axis bending of wide flanges ($0.75F_y$). For a complete and thorough treatment of channel code checks, refer to the LRFD specification.

WT and LL Shapes - ASD allowable bending stresses calculated for WT and LL shapes use Chapter F for cases when the stem is in compression. This is not technically correct, but the ASD code does not provide direction regarding other means of calculating the allowable bending stress in this situation. In the interim, the LRFD code directly addresses this situation, so it is recommended that you use the LRFD code to check WT and LL shapes that have their stems in compression.

Neither the ASD or LRFD codes address the rare case where Lateral Torsional (or Flexural Torsional) Buckling occurs for WT's and double angles bent about their weak axis.

RE Shapes - Rectangular bar members (on-line shapes) are assigned allowable bending stresses for the yielding limit state only. Lateral torsional buckling is not considered because the ASD code doesn't directly address this for rectangular shapes. The strong axis bending stress is assigned as $0.66F_y$ and the weak axis bending stress is assigned as $0.75F_y$. If you have a case where lateral torsional buckling may govern, you should use the LRFD code, since the LRFD code does address this limit state.

LRFD 2nd and 3rd Edition Limitations

Wide Flange Shapes - LRFD code checks for shapes that qualify as plate girders as defined by Chapter G are not performed.

Single Angles - Single angles are only checked for Euler buckling. They are not checked for Flexural-Torsional buckling.

WT and LL Shapes - Neither the ASD or LRFD codes address the rare case where Lateral Torsional (or Flexural Torsional) Buckling occurs for WT's and double angles bent about their weak axis.

Tapered Wide Flanges - ASD 9th edition code checks can be performed on tapered members with equal or unequal top/bottom flanges, with the restriction that the compression flange area must be equal to or larger than the tension flange area. LRFD 2nd edition code checks are limited to tapered members with equal area flanges. Code checks are performed using Appendix F, Chapter F, and Chapter D as applicable. Note that the rate of taper is limited by Appendix F, and the program enforces this. The interaction equations in Appendix F are used to compute the final code check value. These equations also include the effects of weak axis bending, if present.

Prismatic Wide Flanges with Unequal Flanges - ASD code checks for prismatic WF members with unequal flanges are also limited to shapes that have the compression flange area equal to or larger than the tension flange area. LRFD code checks currently cannot be performed for prismatic WF members with unequal flanges.

Pipes and Bars - For pipes and round bars, the code check is calculated based on an SRSS summation of the y and z-axis stresses calculated for the pipe or bar. This is done because these circular shapes bend in a strictly uniaxial fashion and calculating the code check based on a biaxial procedure (as is done for all the other shapes) is overly conservative.

Single Angles - Code checking (LRFD or ASD) on single angle shapes is based on P/A (axial load/axial strength or axial stress/allowable axial stress) only. This is because the load eccentricity information needed for a meaningful bending calculation is not available. Only Euler buckling is considered for single angles, flexural-torsional buckling is NOT considered. Single angles will have the following message displayed on the Code Check Spreadsheet to remind the user of the axial only code check: "Code check based on z-z Axial ONLY"

Please see [Single Angle Stresses](#) for more information on the calculation of single angle stresses.

AISC Design Codes - Special Messages

In some instances, code checks are not performed for a particular member. A message explaining why a code check is not possible will be listed instead of the code check value. You may click the cell that contains the message and look to the status bar to view the full message. The following are the messages that may be listed:

"AISC Code Check Not Calculated"

This message is displayed when the member is not defined with a database shape, a steel code is not specified on the **Model Settings** or no units were specified. For LRFD this message is displayed if the steel yield stress is less than 10ksi.

"Web is slender per Table B5.1, handle as a plate girder"

The ratio h/t_w exceeds the limiting criteria listed in Table B5.1. This means Chapter G (plate girders) governs.

"Compressive stress f_a exceeds F_e (Euler buckling limit)"

The axial compressive stress for the member is greater than the Euler buckling stress (per ASD criteria), meaning the member is unstable. A code check can not be calculated.

"Tube depth > 6*width (Sec F3-1) where width = $b_f - 3*t_w$, Sec B5-1"

A tube is failing to meet the depth/width requirements laid out in Section F3-1 of the ASD code. The depth of the tube is the full nominal depth, which the width is taken as the full width minus 3 times the thickness. Section B5-1 specifies this calculation for the width when the fillet radius is not known.

"Tee or Channel fails on Table A-B5.1 (Appendix B)"

This message appears for ASD code checking when Appendix B calculations are being done for a Tee or Channel shape and the shape fails to meet the requirements of Table A-B5.1, Limiting Proportions for Channels and Tees.

"Pipe diameter/thickness ratio exceeds 13,000/ F_y (App. B)"

This message appears when Appendix B calculations are being done for a pipe shape and the diameter/thickness ratio exceeds the limit of 13000/ F_y specified in Section B5-b for ASD, Section B5-3b for LRFD.

" $KL/r > 200$ for compression member"

Section B7 recommends that KL/r for compression members not exceed 200. For the ASD 9th edition code, a procedure is presented to handle when KL/r exceeds 200. Thus, for ASD 9th edition, $KL/r > 200$ is permitted. For all other AISC codes no guidance is provided as to what to do if $KL/r > 200$, so exceeding this limit is not permitted. You may override this in the **Application Settings** on the **Tools** menu.

"Taper Flange area is not constant per App. A-F7-1 (b)"

The limitations of Appendix F for the design of web tapered members include the restriction that the flange area shall be constant along the length of the member. This member's flange area changes along its length. See Appendix Section F7.1 (b).

"Taper rate exceeds gamma limit per App. A-F7-1 (c)"

The limitations of Appendix F for the design of web tapered members include a limit on how steep the rate of taper can be along the member length. This member's taper rate exceeds the limit given by equation A-F7-1. See Appendix Section F7.1 (c).

"Flanges not equal, currently don't do LRFD App. F1 calcs"

The requirements for Wide Flange members with unequal flanges in the LRFD, Appendix F1, are not addressed.

"Taper Comp. flange < Tension flange, per App A-F7-1 (b)"

The limitations of Appendix F for the design of web-tapered members include the restriction that the flange areas of the top and bottom flange must be equal. The compression flange may be larger than the tension flange. However equation A-F7-4 is unconservative for cases where the compression flange is smaller than the tension flange. See Appendix Sections F7.1 (b) and F7.4.

Canadian Design Codes - Member Design Parameters

Parameters controlling the steel design are entered on the **Member Design Parameters** spreadsheet. These parameters are entered on a per member basis, and control the code checking on a per member basis.

w1 Coefficient

w1 is the coefficient to determine equivalent uniform bending effect in beam-column, as described in Section 13.8.5 of CSA S16-09. If left blank, RISA-2D will calculate it. The w1 value is dependent on the member's end moments, which may change from one Load Combination to the next. Therefore it is a good idea to leave this entry blank and let RISA-2D calculate it.

w2 Coefficient

w2 is the coefficient to account for increased moment resistance of a laterally unsupported doubly symmetric beam segment when subject to a moment gradient, as described in Section 13.6a of CSA S16-09. If left blank, RISA-2D will calculate it. The w2 value is dependent on the moment in the member, which may change from one Load Combination to the next. Therefore it is a good idea to leave this entry blank and let RISA-2D calculate it.

Canadian Design Codes - Limitations

It is assumed the transverse load on the member is occurring through the member's shear center. This means secondary torsional moments that may occur if the load is not applied through the shear center are not considered.

Pipes and Bars - For pipes and round bars, the code check is calculated based on an SRSS summation of the y and z-axis stresses calculated for the pipe or bar. This is done because these circular shapes bend in a strictly uniaxial fashion and calculating the unity check based on a biaxial procedure (as is done for all the other shapes) is overly conservative.

S16-14, S16-09

Tapered Wide Flanges - No code checking is done for "Tapered WF" members which have different "Start" and "End" Depths, or which have top and bottom flanges of different widths. In other words, the "Tapered WF" may only be used for prismatic, doubly symmetric sections.

Single Angles - Single angles in compression are not checked for Clause 13.3.3.2 or 13.3.3.3 because there is insufficient information regarding the connections and usage of the member. They are not checked for Clause 13.3.2 (Flexural-Torsional Buckling) either. Instead they are checked for Euler Buckling about their geometric or principal axes per Clause 13.3.1. The slenderness classification for single angles is based on the longer leg.

S16-09 recommends using a "rational analysis" to account for lateral-torsional buckling and shear checks on single angles, so RISA uses the AISC 360-10 (14th Edition) provisions for these checks.

Class 4 Members - Members with *both* Class 4 (slender) webs *and* Class 4 (slender) flanges are not designed. Per S16-09, Clause 13.5.c.i these members must be designed per S136-07. Where only the web *or* the flange is Class 4 (slender) the capacity is determined per the provisions of S16-09, Clause 13.5c.

The code is not clear on whether this applies to WT, Double Angle, and Single Angle members, since they do not have a "web". Therefore, for these member types, the program calculates an effective (reduced) yield stress for each leg/flange/stem and uses the smallest value for the entire section.

Pipes and Round HSS - The code does not address how to determine the shear capacity of Class 3 or Class 4 (Noncompact, Slender) pipes. Therefore no design is done for those members. Class 1 and 2 member capacities are determined per the provisions of S16-09.

Shear Capacity - The code does not address how to determine the shear capacity of WTs, Double Angles, or Single Angles where shear buckling is a consideration (S16-09 Clause 13.4.3). Therefore no design is done for members where d/w or b_{el}/t exceeds $1014/(F_y)^{1/2}$.

WTs - The lateral-torsional buckling moment capacity calculation (Clause 13.6e.i) in the code does not address how to calculate L_u when the stem of the WT is in compression. Therefore L_u is always taken as zero, which is conservative. The code also does not address how to calculate β_x when the stem is in compression. Therefore, I_{yc} is taken as zero, which results in a negative value of β_x , which is conservative.

Double Angles - The code does not address how to calculate lateral-torsional buckling moment capacity. RISA therefore uses the AISC 360-10 (14th Edition) provisions for these checks, as they are a widely accepted rational method. When this method is used, it is assumed that $C_b = \omega 2$. The slenderness classification for double angles is based on the longer leg.

Welded Reduced Flange (WRF) Members- Since these members are classified within RISA as "Tapered", there is currently no design done for them. This limitation will be removed in a future release.

Torsional Buckling and Flexural Torsional Buckling (S16-09 and earlier) - The limit states of torsional buckling and flexural torsional buckling are not considered for wide flange and channel members. This means that the value F_{ez} is not calculated for these members per Clause 13.3.2. The program takes the lesser of F_{ex} and F_{exy} for axial buckling capacity for the S16-09 and earlier codes. These limit states are fully considered for S16-14 because an L_{torque} input was added for S16-14 that was not present in earlier code implementations.

Compressive Strength (S16-09 and earlier) - For the equations in section 13.3.1, the parameter "n" is assigned a value of 1.34 for all shapes for S16-09 and earlier codes. This is conservative for WWF shapes and HSS shapes that are stress-relieved. For S16-14, members designated as type "Tapered WF" use $n = 2.24$ while members designated as type "WF" use $n = 1.34$.

Double Channels - Double channel design for Canadian code is only available in S16-14. Connector spacing requirements are not checked for double channels.

S16.1-94, S16-01, S16-05

WT and LL Shapes - The criteria in the AISC LRFD 2nd Edition code is used to perform code checks on WT and LL shapes since the Canadian code does not explicitly specify how to calculate the flexural strength of WT and LL shapes.

The Canadian code does not address the rare case where Lateral Torsional (or Flexural Torsional) Buckling occurs for WT's and double angles bent about their weak axis.

Tapered Wide Flanges - The AISC LRFD 2nd code is used to perform code checks on Tapered WF shapes when the Canadian code is specified. The Canadian code CAN/CSA S16.1-94 does not address web-tapered members.

Single Angles - Code checking on single angle shapes is performed for tension only. Single angles will have the following message displayed on the Steel Code Check Spreadsheet to remind the user of the tension only code check: "Single Angle code check based on Axial Tension ONLY"

Please see [Single Angle Stresses](#) for more information on the calculation of single angle stresses.

Slender Shapes - Shapes with any slender elements are not supported for axial compression. Shapes with slender webs or flanges are not supported for flexure. These shapes use the criteria in the CAN/CSA S136 code, which is not supported at this time.

Canadian Design Codes - Special Messages

When a code check is not performed for a particular member a message explaining why a code check is not possible will be listed instead of the code check value. You may click the cell that contains the message and look to the status bar to view the full message. Following are the messages that may be listed specifically for the Canadian Code:

"Tension member with L/r ratio > 300 (CAN Sect. 10)"

The maximum L/r ratio for this tension member exceeds the limit shown in Section 10.2.2 of the CAN/CSA S16.1-94 code.

"KL/r > 200 for compression member (CAN Sect. 10)"

The maximum L/r ratio for this compression member exceeds the limit shown in Section 10.2.1 of the CAN/CSA S16.1-94 code. You may override this check in the **Application Settings** on the **Tools** menu.

"Can't do unity check for slender compression member"

Compression strengths are not calculated for shapes that contain elements where the width to thickness ratios are classified as "slender".

"Can't do unity check for flexural member with slender web"

Flexural strengths are not calculated for shapes which have a web depth to thickness ratio classified as "slender".

"Currently can't do unity check for member with slender flanges"

Flexural strengths are not calculated for shapes which have a flange width to thickness ratio classified as "slender".

"Can't do unity check for single angles in compression"

Compression strengths are not calculated for single angle members.

British Design Code - Member Design Parameters

Parameters controlling the steel design are entered on the **Member Design Parameters** spreadsheet. These parameters are entered on a per member basis, and control the code checking on a per member basis.

m Coefficients (Interactive Bending Coefficients)

Section 4.8.3.3.4 of the British code describes the m coefficient. If these entries are left blank, RISA will calculate them. The m value is influenced by the sway condition of the member and is dependent on the member's end moments, which will change from one Load Comb to the next. It's a good idea to leave these entries blank and let RISA calculate them.

m-LT Coefficients (Bending Coefficients)

This coefficient is discussed in Section 4.3.6.6 of the BS5950-1:2000 code and is used in the calculation of the flexural strength. If this entry is left blank it will be calculated automatically. This value also is impacted by

the member's sway condition and is dependent on the member's end moments so it may be a good idea to let it be calculated internally. An exception to this would be for cantilever members in sway frames, this value should be 1.75, and it will be automatically calculated as 1.0. This will be addressed in a future program version.

British Design Code - Limitations

It is assumed the transverse load on the member is occurring through the member's shear center. This means secondary torsional moments that may occur if the load is not applied through the shear center are not considered.

Tapered Members - Tapered WF shapes are done per the AISC LRFD 2nd specification at this time. The appropriate sections of the BS5950-1 specification will be used in a later release.

Torsional Warping Effects - Combined bending and warping torsional stresses in WF and Channel shapes are handled per the AISC publication "Torsional Analysis of Steel Members". A later release will use the SCI publication "Design of Members Subject to Combined Bending and Torsion" for combined bending and warping stresses when the British Hot Rolled Steel code is selected.

Single Angles - Single angles are checked for axial and shear forces only. No bending is considered at this time. A later release will consider the requirements in Annex I4 for single angles.

Secondary Moments per Annex I - The program does not yet consider the internal secondary moments described in Annex I.

EuroCode Design Codes - Member Design Parameters

Parameters controlling the steel design are entered on the **Member Design Parameters** spreadsheet. These parameters are entered on a per member basis, and control the code checking on a per member basis.

C_m Factors (Equivalent Uniform Moment Factors per the 2005/14 EuroCode)

If these entries are left blank, RISA will calculate them per Annex B of the 2005/ 2014 EuroCode otherwise the user can choose to override the calculation by manually entering a value. The C_m value is influenced by the sway condition of the member and is dependent on the member's end moments, which will change from one Load Combination to the next. It's a good idea to leave these entries blank and let RISA calculate them.

For HSS Tubes, the program always uses Table B.1. For other members not subject to torsion deformations (wide flange members with an unbraced length equal to zero) the program will use Table B.1. for the 2014 code. All other members, the program will use table B.2.

C_m-LT Factor (LTB Equivalent Uniform Moment Factors per the 2005 EuroCode)

If this entry is left blank, RISA will calculate it per Table B.3 in Annex B of the 2005 EuroCode, otherwise the user can choose to override the calculation by manually entering a value. The C_{mLT} value is influenced by the sway condition of the member and is dependent on the member's end moments, which will change from one Load Combination to the next. It's a good idea to leave these entries blank and let RISA calculate them.

B_m Coefficients (Interactive Bending Coefficients per the 1992 EuroCode)

Section 5.5.4 (7) of the EuroCode describes the B_m coefficients. If these entries are left blank, RISA will calculate them. The B_m value is influenced by the sway condition of the member and is dependent on the member's end moments, which will change from one Load Comb to the next. It's a good idea to leave these entries blank and let RISA calculate them.

B_m-LT Coefficient (LTB Bending Coefficient per the 1992 EuroCode)

This coefficient is discussed in Section 5.5.4 (7) of the 1992 EuroCode code and is used in the calculation of the flexural strength. If this entry is left blank it will be calculated automatically. This value also is impacted by

the member's sway condition and is dependent on the member's end moments so it may be a good idea to let it be calculated internally. An exception to this would be for cantilever members in sway frames, this value should be 1.75, and it will be automatically calculated as 1.0. This will be addressed in a future program version.

C1 Factor (Moment Distribution Modification Factor)

If this entry is left blank, RISA will calculate it per the explicit equation presented in the widely accepted article "[Lateral-Torsional Buckling of Steel Beams: A General Expression for the Moment Gradient Factor](#)" by López, Yong, and Serna (2006), as there is no suitable generic formula presented in the EuroCode.

$$C_1 := \frac{\sqrt{\sqrt{k_1} \cdot A_1 + \left(\frac{(1-\sqrt{k})}{2} \cdot A_2\right)^2} + \frac{(1-\sqrt{k})}{2} \cdot A_2}{A_1}$$

López, Yong, and Serna
Eqn. (8)

$$C_2 := 0$$

$$C_3 := 0$$

Where:

$$A_1 := \frac{M_{max}^2 + \alpha_1 \cdot M_1^2 + \alpha_2 \cdot M_2^2 + \alpha_3 \cdot M_3^2 + \alpha_4 \cdot M_4^2 + \alpha_5 \cdot M_5^2}{(1 + \alpha_1 + \alpha_2 + \alpha_3 + \alpha_4 + \alpha_5) \cdot M_{max}^2}$$

López, Yong, and Serna
Eqn. (10)

$$A_2 := \left| \frac{M_1 + 2 \cdot M_2 + 3 \cdot M_3 + 2 \cdot M_4 + M_5}{9 \cdot M_{max}} \right|$$

López, Yong, and Serna
Eqn. (11)

Otherwise the user can override this calculation by manually entering a value.

Note:

- C2 and C3 are taken as zero because RISA relies on the "general case" lateral torsional buckling equations (see section 6.3.2.2) rather than the more specialized section for rolled and welded I shaped sections (6.3.2.3).

EuroCode Buckling Curve Factors

This factor is discussed in Section 6.3.1.2 of the 2014 EuroCode and is used in the calculation of the axial compression. Table 6.1 is used except for when Lateral Torsional Buckling is considered then Table 6.4 is used instead. The following illustrates what RISA uses for the buckling curve from Table 6.2:

Table 6.2 (as implemented by RISA)

Cross Section	Limits	Material Type	Imperfection Factor (Weak Axis)	Imperfection Factor (Strong Axis)
Wide Flange: $h/b > 1.2$	$t_f \leq 40$ mm	$f_y = 460$ MPa Other	0.13 0.34	0.13 0.21
	40 mm $< t_f \leq 100$ mm	$f_y = 460$ MPa Other	0.21 0.49	0.21 0.34
	$t_f > 100$ mm	$f_y = 460$ MPa Other	0.49* 0.76*	0.49* 0.76*
Wide Flange: $h/b \leq 1.2$	$t_f \leq 100$ mm	$f_y = 460$ MPa Other	0.21 0.49	0.21 0.34
	$t_f > 100$ mm	$f_y = 460$ MPa Other	0.49 0.76	0.49 0.76
Tubes & Pipes	2014 code (Cold Formed)	All	0.34	0.34
	prior codes (Hot Finished)	$f_y = 460$ MPa Other	0.13 0.21	0.13 0.21
Channels			0.49	0.49
WT and LL			0.49	0.49
Single Angles	2014 code		0.34	0.34
	prior		0.49	0.49
Solid Bar or Rect			0.49	0.49
Tapered WF	$t_f \leq 40$ mm (Hot Finished)		0.49	0.34
	$t_f > 40$ mm (Hot Finished)		0.76	0.49

* The EuroCode does not give guidance on which curve to use in these situations.

Buckling Curve	a ₀	a	b	c	d
Imperfection Factor	0.13	0.21	0.34	0.49	0.76

EuroCode Design Codes - Limitations

Tapered Members - Tapered member design per the Eurocode is not supported at this time.

Torsional Warping Effects - Combined bending and warping torsional stresses in WF and Channel shapes are handled per the AISC publication "*Design Guide #9- Torsional Analysis of Steel Members*".

WT and Double Angle Limitations - The EuroCode does not address the rare case where Lateral Torsional (or Flexural Torsional) Buckling occurs for WT's and double angles bent about their weak axis. Therefore, the calculation of M_{cr} is based on AISC LRFD equation and used in the code checks for Lateral Torsional (or Flexural Torsional) Buckling.

Lateral Torsional Buckling - The value M_{cr} used in the lateral-torsional buckling capacity of beams relies on a factor C1. When the C1 field is left blank it is automatically calculated per the explicit equation presented in the widely accepted article "[Lateral-Torsional Buckling of Steel Beams: A General Expression for the Moment Gradient Factor](#)" by López, Yong, and Serna (2006), as there is no suitable generic formula presented in the EuroCode. C2 and C3 are taken as zero because RISA relies on the "general case" lateral torsional buckling equations (see section 6.3.2.2) rather than the more specialized section for rolled and welded I shaped sections (6.3.2.3).

Single Angles - Single angles are checked for axial and shear forces only for EuroCodes prior to 2014 Edition. No bending is considered for Eurocodes prior to 2014 Edition.

EuroCode Design Codes - Special Messages

"Rho >= 1.0, No code check calculated"

In beams with high shear the code implements a moment strength reduction factor (ρ), but does not place an upper limit on it. If this value exceeds 1.0 the beam has a negative moment capacity, which is irrational. The program therefore prevents a code check for these circumstances.

Indian Design Codes - Member Design Parameters

Parameters controlling the steel design are entered on the **Member Design Parameters** spreadsheet. These parameters are entered on a per member basis, and control the code checking on a per member basis.

Cm Coefficients (Interactive Bending Coefficients)

If these entries are left blank, RISA will calculate them. The m value is influenced by the sway condition of the member and is dependent on the member's end moments, which will change from one Load Comb to the next. It's a good idea to leave these entries blank and let RISA calculate them.

Indian Buckling Curve Factors

This factor is discussed in Section 7.1.2.2 of the 2007 Indian Design code and is used in the calculation of the axial compression. The following illustrates what RISA uses for the buckling curve from Table 7:

Table 10 Buckling Class of Cross-Sections (in RISA)

Cross Section	Limits	Imperfection Factor (Weak Axis)	Imperfection Factor (Strong Axis)
Wide Flange $h/b > 1.2$	$tf \leq 40\text{mm}$	0.34	0.21
	$40\text{mm} < tf \leq 100\text{mm}$	0.49	0.34
	$tf > 100\text{mm}$	0.76*	0.76*
Wide Flange $h/b \leq 1.2$	$tf \leq 100\text{mm}$	0.49	0.34
	$100\text{mm} < tf$	0.76	0.76
Tubes & Pipes		0.34	0.34
Channels		0.49	0.49
WT and LL		0.49	0.49
Single Angles	2014 code	0.49	0.49
Solid Bar or Rect		0.49	0.49
Tapered WF	$tf \leq 40\text{mm}$ (Hot Finished)	0.49	0.34
	$40\text{mm} < tf$ (Hot Finished)	0.76	0.49

* The Indian Code does not give guidance on which curve to use in these situations.

Buckling Curve		a	b	c	d
Imperfection Factor		0.21	0.34	0.49	0.76

Indian Design Codes - Limitations

Tapered Members - Tapered WF shapes are done per the AISC ASD 9th (for the 1998 code) and LRFD 2nd (for the 2007 code) specifications at this time. The appropriate sections of the IS:800 specification will be used in a later release.

Torsional Warping Effects- Combined bending and warping torsional stresses in WF and Channel shapes are handled per the AISC publication "Torsional Analysis of Steel Members".

WT and Double Angle Limitations - The Indian code does not address the case where Lateral Torsional (or Flexural Torsional) Buckling occurs for WT's and double angles bent about their weak axis. For the 2007 code, RISA will use the AISC 360-05 (aka AISC 13th edition) formulas for calculating member capacity for these failure states.

Shear Stress - For all shapes, the average shear stress is not checked per section 6.4.2 at this time.

Class 4 (Slender) Sections - No code checking is performed for class 4 sections for the IS 800: 2007 code.

Single Angles - Single angles are checked for axial and shear forces only. No bending is considered at this time.

Australian & New Zealand Design Codes - Member Design Parameters

Parameters controlling the steel design are entered on the **Member Design Parameters** spreadsheet. These parameters are entered on a per member basis, and control the code checking on a per member basis.

Alpha_m Factor (Moment Modification Factor)

1. If this entry is left blank, RISA will calculate it based on the full length of the member.
2. When unbraced lengths ($L_{b_comp_top}$ and $L_{b_comp_bot}$) are explicitly defined (enter a number), the program does not have the segmental information of the member for α_m calculation.

It will assume the α_m used for this particular member to be 1.0.

3. When unbraced lengths ($L_{b_comp_top}$ and $L_{b_comp_bot}$) are defined by physical nodes along the member with the entry 'Segment' typed in, α_m will be calculated automatically using equation 5.6.1.1(2) based on segments defined by nodes along the member.

The α_m value is influenced by the sway condition of the member and is dependent on the member's end moments, which will change from one Load Combination to the next.

Australian & New Zealand Design Codes - Limitations

Tapered Members - Tapered WF shapes are done per the AISC LRFD 3rd specification at this time. The appropriate sections of the ENV 1993-1-1 specification will be used in a later release.

Torsional Warping Effects- Combined bending and warping torsional stresses in WF and Channel shapes are handled per the AISC publication "Torsional Analysis of Steel Members".

WT and Double Angle Limitations - The NZ / AS codes do not address the rare case where Lateral Torsional (or Flexural Torsional) Buckling occurs for WT's and double angles bent about their weak axis.

Torsional Unbraced Length - At present the program assumes 'Lcomp' as 'Le' in case of lateral torsional buckling. Section 5.6.3 provides a procedure for calculating 'Le' which is not being addressed at this time.

Special Provisions for Cantilevers - At present the program does not address section 5.6.2 for cantilever elements.

General Member Design Limitations

Composite Steel Design - This is not done in RISA-2D. RISAFloor has this capability.

Welded Sections - There is a basic assumption in the program that the steel sections are hot rolled not welded. Therefore, any code provisions that assume additional stresses due to welding a built-up cross section are not specifically accounted for. For the AISC-LRFD codes this generally means that the flange residual stress (F_r) is always taken as 10ksi, as for a rolled shape. The only exception is for Tapered WF shapes where it is always taken as 16.5 ksi, as for a welded shape.

Load Location - For all shape types, it is assumed that the transverse load on the member is occurring through the member's shear center. This means secondary torsional moments that may occur if the load is not applied through the shear center are not considered.

Single Angles - In all codes other than AISC 360-05 and 360-10, single angles are only checked for axial loading. Flexural effects are not considered in the code check calculation. Under AISC 360-05 and 360-10 single angles are checked for combined bending and axial about either their principal or geometric axes depending on how their [unbraced length](#) has been defined.

- Lateral-Torsional buckling does not apply to Geometric bending angles, and is therefore not checked for them.
- Lateral-Torsional buckling does not apply to minor-axis bending on Principal bending angles, and is therefore not checked for them.
- The provisions of Section E5 of the specification are not considered. The angle is considered to be loaded concentrically, and on both legs.
- Interaction equation H2-1 is used for all the code check on all angles (equal and unequal leg).

Double Angles - For y axis buckling (where stitch connections would be experiencing shear), the program only considers KL/r of the overall built up shape and does NOT attempt to reduce the KL/r value based on the spacing between connectors. Therefore the program assumes that there are pre-tensioned bolts or welds spaced closely enough to allow the double-angles to act as one unit per AISC 360-10 Eqn E6-2a.

Net Section for Tension Capacity - The tension capacity is calculated using the Gross area. A later release will include a "net area factor" that the user can enter to indicate what the effective area should be for the tension capacity calculation.

Solid Rectangles - Solid rectangular members will not be checked for lateral torsional buckling. This limitation is only important for tall, slender shapes as LTB should not be a realistic limit state for short and thick or square shapes.

Torsional and Flexural Torsional Buckling of Doubly Symmetric Shapes - Flexural Torsional Buckling and Torsional Buckling are checked for the following shape types for AISC 360-10 (14th Edition) and AISC 360-16 (15th Edition) steel codes:

- Non Slender WF
- Non Slender Channels
- Non Slender WTs
- Non Slender Double Angles
- Non Slender Single Angles

Flexural Torsional Buckling and Torsional Buckling are also checked for Non Slender WTs and Double Angles for the AISC 360-05 (13th Edition Steel Code).

For WTs $(KL/r)_m$ per section E4 (a) is calculated per equation E6-1 with 'a' always assumed to be 0. This results in $(KL/r)_m = (KL/r)_o$.

P-Little Delta Analysis - An incremental P-Delta re-iterative approach is used in RISA 3D. This method does NOT automatically account for P-Little Delta effects. If these effects are expected to be significant please refer to the [P-Little Delta](#) section.

Tapered Members

The analysis for tapered wide flange members is handled internally by breaking the member into a series of 14 piecewise prismatic members. Then the program will condense out the extra degrees of freedom when assembling the stiffness matrix.

This does a very good job for member stiffness and basic analysis. However, because the extra degrees of freedom are eliminated before the analysis, it does not currently account for the P-Little Delta effect. If this effect is desired, please refer to the [P-Little Delta](#) topic for techniques to add this effect into your frame analysis.

AISC 13th, 14th, and 15th Editions - Design Guide 25

These design specifications do not actually include any design provisions for tapered members. However, the AISC and MBMA jointly released *Design Guide 25 - Frame Design Using Web-Tapered Members*, which provides a design procedure consistent with the AISC design specifications.

RISA follows the recommendations of the *Design Guide* for tapered member codes checks whenever the AISC 13th, 14th, or 15th edition steel codes are selected.

Design Checks:

The member detail reports will display not only the governing capacity values, but also the governing equations/limit state that provided the reported capacity. These limit states (and any design assumptions) are listed below:

In-Plane Flexural Buckling (z-z): The RISA implementation uses the Equivalent Moment of Inertia method described in Appendix A of Design Guide 25.

Out-of-Plane Flexural Buckling (y-y): This calculation uses the weak axis properties from the mid-section of the unbraced length.

TB (Torsional Buckling): Columns with equal flanges will only be checked for Torsional Buckling when the torsional unbraced length ($K \cdot L_{\text{torque}}$) is greater than the weak axis buckling unbraced length ($K \cdot L_y$).

FTB (Torsional Buckling): RISA currently only checks flexural torsional buckling when the tapered member has unequal flange widths and (for cases when flange widths are equal) when the ratio of the flange thickness is greater than 1.5. This calculation uses the weak axis properties from the mid-section of the unbraced length.

LTB (Lateral Torsional Buckling): The RISA implementation uses the procedure for Single Linear Tapered Members for most members. In cases where both the thickness and depth of the way change, however, the program will use the more generalized procedure.

CAT (Constrained Axis Torsional Buckling): This is only checked when $L_{\text{comp-bottom}}$ is greater than $L_{\text{comp-top}}$. The assumption is that the top flange is the outside flange and may be more restrained due to the presence of purlins or girts. The calculation of a_s and a_c assume a girt or purlin depth of zero.

Combined Stress Equations: The RISA implementation uses the force based combined strength equations from chapter H1 of the AISC specification. The program does not consider the alternate stress based combined stress equations based on chapter H2 of the AISC specification.

Shear Strength: The shear check equations are based on section G2 of the AISC specification and do not consider the effects of stiffeners or tension field action.

Please see the Tapered Member [results](#) topic for more information about the results reporting.

Unbraced Length and Section Properties: When the user manually enters an unbraced length the program doesn't explicitly know where the brace points are and must make an assumption. This is done in order to determine the section properties at the middle of the unbraced length which are used in the calculation of member capacities. RISA assumes the brace points are equally spaced along the length of the member at the distance given by the user.

For example if the user entered in an unbraced length of 4 ft for a tapered member that is 10 ft long, the program will assume that there is bracing at 0ft, 4ft, 8ft and 10ft.

Limitations:

In general, this *Design Guide* allows for design of a wider range of members than permitted over the older AISC Appendix F provisions. However, there are still a number of limitations that will prevent RISA from reporting a code check. These are listed below:

Cb Calculation: Currently, RISA does not calculate C_b per Design Guide 25. Instead it is always calculated per the AISC 360 section F1 equation.

Tension Rupture: The tension rupture limit state is not considered.

Flange Q_s Calculations: RISA will calculate a Q_s value for both flanges and conservatively use the lower value in design calculations.

Direct Analysis Method: Currently, the τ_b stiffness adjustments for the Direct Analysis Method is based on the worst case section in the tapered member. This worst case stiffness adjustment is applied to the whole member.

55 ksi Limit: The *Design Guide* includes a 55 ksi limit on maximum yield strength. If this is violated a code check will still be calculated, but a warning log message will be given.

ASD 9th, LRFD 2nd, LRFD 3rd

For these design specifications, AISC included an Appendix F covering the design of tapered wide flange members. When calculating code checks per these provisions, the design parameters used in RISA are subject to the following additions / restrictions:

AutoCalc of K values: The **K-out** factor for Tapered WF shapes can be approximated by RISA-2D, and is the same as for a regular prismatic member. The **K-in** value cannot be approximated by RISA-2D and should be entered by the user. The default value for **K-in** will be '1.0' if not entered by the user. See the ASD or LRFD Commentary on Appendix F for an explanation of how to calculate the **K-in** factor for Tapered members.

Cb value: For Tapered WF members, the Cb field is actually used to enter the "B" value. B is described in Appendix F7.4 of the ASD (9th Edition) and LRFD (2nd & 3rd Edition) codes. This value is not calculated automatically and if it is left blank, a value of '1.0' will be used per the commentary for Appendix F7. The Cb term used in the Chapter F equations is calculated internally for Tapered WF members and will be shown on the Member Detail report and in the Code Check Spreadsheet.

Cm values: For Tapered WF members, the Cm values will be used for C'm. The C'm values are described in Appendix F7.6 of the ASD and LRFD codes. These terms are used in the interaction equations in Appendix F. If these entries are left blank they will be calculated automatically.

Foreign Codes

Canadian - w1: For Tapered WF members, the LRFD code will be used and the Cmyy(w1yy) value will be used for C'myy, and the Cmzz(w1zz) value will be used for C'mzz. The C'm values are described in Appendix F7.6 of the LRFD codes. These terms are used in the interaction equations in Appendix F for the LRFD code. If these entries are left blank RISA will calculate them.

Canadian - w2: For Tapered WF members the LRFD code will be used and the w2 field is used for the "B" value. B is described in Appendix F7.4 of the LRFD codes. The Cb term used in the Chapter F equations in the LRFD code is always calculated internally for Tapered WF members and will be shown on the Member Detail report and in the Unity check spreadsheet. If the w2 entry is left blank a value of 1.0 will be used for B, per the commentary for Appendix F7. (The value of "B" is not calculated at this time.)

British - m: For Tapered WF members, the LRFD code will be used and the Cmyy(m_yy) value will be used for C'myy, and the Cmzz(m_zz) value will be used for C'mzz. The C'm values are described in Appendix F7.6 of the LRFD codes. These terms are used in the interaction equations in Appendix F for the LRFD code. If these entries are left blank RISA will calculate them.

British - m_LT - For Tapered WF members the LRFD code will be used and the m-LT field is used for the "B" value. B is described in Appendix F7.4 of the LRFD codes. The Cb term used in the Chapter F equations in the LRFD code is always calculated internally for Tapered WF members and will be shown on the Member Detail report and in the Unity check spreadsheet. If the m-LT entry is left blank a value of 1.0 will be used for B, per the commentary for Appendix F7. (The value of "B" is not calculated at this time.)

Euro Code - Cm/Bm: For Tapered WF members, the AISC LRFD 2nd Edition code is used and the Cmyy(m_yy) value will be used for C'myy, and the Cmzz(m_zz) value will be used for C'mzz. The C'm values are described in Appendix F7.6 of the LRFD codes. These terms are used in the interaction equations in Appendix F for the LRFD code. If these entries are left blank RISA will calculate them.

Euro Codes - Cm_LT / Bm_LT: For Tapered WF members the AISC LRFD 2nd Edition code is used and the m-LT field is used for the "B" value. B is described in Appendix F7.4 of the LRFD codes. The Cb term used in the Chapter F equations in the LRFD code is always calculated internally for Tapered WF members and will be shown on the Member Detail report and in the Unity check spreadsheet. If the m-LT entry is left blank a value of 1.0 will be used for B, per the commentary for Appendix F7. (The value of "B" is not calculated at this time.)

Indian Codes - Cm: For Tapered WF members, the LRFD code will be used and the $C_{myy}(m_{yy})$ value will be used for C'_{myy} , and the $C_{mzz}(m_{zz})$ value will be used for C'_{mzz} . The C'_m values are described in Appendix F7.6 of the LRFD codes. These terms are used in the interaction equations in Appendix F for the LRFD code. If these entries are left blank RISA will calculate them.

Hot Rolled Steel - Design Results

AISC Code Check Results

Access the **Steel Code Check** spreadsheet by selecting the **Results** menu and then selecting **Members ▶ Steel Code Checks**.

LC	Member	Shape	UC Max	Loc	Shear	Loc	Fa	Ft	Fb	Cb	Cm	Eqn
1	M14	W12X19	.196	26.25	.004	26.25	1.016	30	4.391	1	.85	H1-1
2	M15	W12X19	.196	0	.004	0	1.016	30	4.391	1	.85	H1-1
3	M16	W12X53	.049	0	.002	0	12.305	30	37.5	1.75	.6	H1-2
4	M17	W12X53	.038	0	.000	0	12.305	30	37.5	1	.6	H1-1
5	M18	W12X53	.049	0	.002	0	12.305	30	37.5	1.75	.6	H1-2
6	M14	W12X19	.470	0	.004	0	1.016	30	4.391	1	.85	H1-1
7	M15	W12X19	.470	26.25	.004	26.25	1.016	30	4.391	1	.85	H1-1
8	M16	W12X53	.176	13.982	.009	10.19	12.305	30	37.5	1.75	.6	H1-2

Note:

- The [Member Detail Report](#) gives more values used to perform the code check.
- See [Spreadsheet Operations](#) to learn how to use **Find**, **Sort** and other options.
- See [Model Display Options – Members](#) to learn how to plot member results.
- See the code specific topics on the [Hot Rolled Steel - Design](#) page for additional restrictions / limitations.

Unity Check (UC) Results

The **UC Max** value represents the maximum Unity Check value produced by the interaction of the axial and bending stresses. This would be a factored ratio of actual to allowable stress, or demand vs capacity. The governing code equation that resulted in this value is displayed in the far right column for reference as well.

The **Shear UC** represents a similar ratio based on the shear provisions of the design code. The location for the shear check is followed by "y" or "z" to indicate the direction of the shear.

Generally, if UC Checks are less than 1.0, the member is considered passing. If either of them is greater than 1.0, the member is considered failing. If the value is greater than 9.999 it will be listed as "9.999".

The remaining columns, discussed below, provide some of the values used in the code check with the equation number itself given in the last column. The [Member Detail Report](#) gives more values used to perform the code check.

Location of the Governing Unity Check

The **Loc** field tells at what location the maximum code check occurs measured from the I-joint location (starting end) of the member. See [Model Display Options – Members](#) to learn how to view the code check results graphically.

The moving load results are enveloped and the governing load combination and step location is shown for each result value under the "LC" column. The first number is the load combination, the second is the step number: (load combination - step number). See [Moving Loads](#) to learn more.

Design Capacities

For ASD 13th, 14th, and 15th Edition code checking, **Pnc/Om**, **Pnt/Om**, **Mnyy/Om** and **Mnzz/Om** are the design capacities divided by the Omega safety factors. Whereas the LRFD code checks will display the capacities multiplied by the Phi factor: **Phi*Pnc**, **Phi*Pnt**, **Phi*Mnyy**, and **Phi*Mnzz**.

For **Pnc** is calculated according to the provisions of Chapter E in the AISC 13th, 14th, or 15th Editions. **Pnt** is based on Chapter D. The **Mn** values are calculated based on Chapter F. Note that for RISA-2D, "zz" corresponds to "xx" in the AISC code, i.e. RISA-2D substitutes Mnzz for Mnx, to maintain consistency with the member local axis system.

Note:

- AISC code checking requires a P-Delta analysis to satisfy the requirements of Chapter C, so if P-Delta analysis is NOT turned on (via the P-Delta flag) code checks won't be performed.

Cb Coefficient

The Cb coefficient is calculated based on the description presented in Chapter F, section F1. Refer to the section on [Cb input](#) for more information about this calculation.

Tapered Wide Flanges (ASD) - For Tapered WF shapes, the Cb value shown will be the Cb value that RISA-2D calculated internally, NOT the value that was entered and used for the "B" value. The values shown in the Cm fields will be the C'm values that were used for the Appendix F calculations. The controlling equation from Appendix F will be listed.

Tapered Wide Flanges (LRFD) - For Tapered WF shapes, the Cb value shown will be the Cb value that RISA-2D calculated, NOT the Cb value that was entered and used for the "B" value. The controlling equation from Chapter H will be listed.

Governing Equation

The final field lists the controlling equation for the code check. This will be one of the equations from Chapter H (for ASD and LRFD) or section 7 for the HSS code. If there is no moment demand in the member being checked, then the program will calculate the unity ratio using Chapter D where it compares the axial demand to the axial capacity of the member using $P_u/(\Phi \cdot P_c)$.

Note:

- The requirements of Section H3 of the LRFD code are satisfied since RISA-2D calculates and includes torsional warping effects.
- When the governing equation is flagged with an asterisk (*) that means the equation was modified slightly. Example AISC equation H1-1b was used, but the code check was not allowed to be less than $P_u/(\Phi \cdot P_c)$.

Load Combination

For enveloped results the combination that produced the listed code and shear checks is given in the "LC" column. The other values are the corresponding values and are not necessarily the maximums across all the combinations.

Canadian Code Check Results

Access the **Steel Code Check** spreadsheet by selecting the **Results** menu and then selecting **Members ▶ Steel Code Checks**.

Member CAN/CSA-S16 Steel Code Checks (By Combination)													
Hot Rolled Steel Cold Formed Steel Wood Concrete Beams Concrete Columns													
	LC	Member	Shape	UC Max	Loc[m]	Shear...	Loc[m]	Cr[k]	Tr[k]	Mr[k-m]	w2	w1	Eqn
1	1	M14	W12x19	.118	26.25	.003	26.25	9.668	250.65	12.761	1.058	1	13_8_2c
2	1	M15	W12x19	.118	0	.003	0	9.668	250.65	12.761	1.058	1	13_8_2c
3	1	M16	W12x53	.022	0	.002	0	262.457	702	109.125	1.75	.6	13_8_2
4	1	M17	W12x53	.028	0	.000	0	262.457	702	109.125	1.75	.6	13_3
5	1	M18	W12x53	.022	0	.002	0	262.457	702	109.125	1.75	.6	13_8_2
6	2	M14	W12x19	.282	0	.003	0	9.668	250.65	12.185	1.01	1	13_8_2c
7	2	M15	W12x19	.282	26.25	.003	26.25	9.668	250.65	12.185	1.01	1	13_8_2c
8	2	M16	W12x53	.084	13.982	.006	10.19	262.457	702	109.125	1.75	.6	13_8_2

Note:

- The [Member Detail Report](#) gives more values used to perform the code check.
- See [Spreadsheet Operations](#) to learn how to use **Find**, **Sort** and other options.
- See [Model Display Options – Members](#) to learn how to plot member results.
- See the code specific topics on the [Hot Rolled Steel - Design](#) page for additional restrictions / limitations.

Unity Check (UC) Results

The **UC Max** value represents the maximum Unity Check value produced by the interaction of the axial and bending stresses. This would be a factored ratio of actual to allowable stress, or demand vs capacity. The governing code equation that resulted in this value is displayed in the far right column for reference as well.

The **Shear UC** represents a similar ratio based on the shear provisions of the design code. The location for the shear check is followed by "y" or "z" to indicate the direction of the shear.

Generally, if UC Checks are less than 1.0, the member is considered passing. If either of them is greater than 1.0, the member is considered failing. If the value is greater than 9.999 it will be listed as "9.999".

The remaining columns, discussed below, provide some of the values used in the code check with the equation number itself given in the last column. The [Member Detail Report](#) gives more values used to perform the code check.

Location of the Governing Unity Check

The **Loc** field tells at what location the maximum code check occurs measured from the I-joint location (starting end) of the member. See [Model Display Options – Members](#) to learn how to view the code check results graphically.

Design Capacities

Cr, **Mr_{yy}** and **Mr_{zz}** are the factored resistances calculated for the member. **Cr** is the compressive resistance, calculated according to the provisions of the design code. The **Mr** values are the moment resistances, calculated based on provisions of the design code. Note that for RISA-2D, "zz" corresponds to "xx" in the Canadian code, i.e. RISA-2D substitutes Mr_{zz} for Mr_x, to maintain consistency with the member local axis system.

Note:

- Canadian code checking requires a P-Delta analysis to satisfy the requirements of Section 8.6, so if P-Delta analysis is NOT turned on (via the P-Delta flag) Canadian code checks won't be done.

W2 Coefficient

The w2 coefficient is calculated based on the description presented in Section 13.6. Whether or not the member is subject to sidesway is determined from the setting for the strong axis sway flag on the **Member Design**

spreadsheet. The w_1 coefficients, described in Section 13.8.4 are also listed. These are also influenced by the sway flag settings.

Tapered Wide Flanges - For Tapered WF shapes, the provisions of the AISC LRFD 2nd code are used. The w_2 value shown will be the w_2/C_b value that RISA-2D calculated, NOT the w_2 value that was entered and used for the "B" value. The controlling equation from Appendix F in the LRFD code will be listed. The values shown under the headers for C_r and M_r will instead be the P_n and M_n values calculated for the LRFD code. These are the unfactored member strengths. (Similar to C_r and M_r , but without the "phi" reduction factor.)

Governing Equation

The final field lists the controlling equation for the code check. This will be one of the equations from Section 13.8.1, 13.8.2, or 13.9.

Note:

- The requirements of Section 15.11 are satisfied since RISA-2D calculates and includes torsional warping effects.

Load Combination

For enveloped results the combination that produced the listed code and shear checks is given in the "LC" column. The other values are the corresponding values and are not necessarily the maximums across all the combinations.

British Code Check Results

Access the **Steel Code Check** spreadsheet by selecting the **Results** menu and then selecting **Members** ▶ **Steel Code Checks**.

LC	Member	Shape	UC Max	Loc [ft]	Shear	Loc [ft]	Pc [k]	Pz [k]	Mc [k-ft]	m LT	m	Eqn
47	10	M15	.965	0	.023	0	10.309	278.5	11.483	.44	.43	4.8.3.3.1b
48	10	M16	.207	9.953	.006	0	293.914	780	79.873	1	.8	4.8.3.3.1a
49	10	M17	.295	9.953	.012	0	293.914	780	79.873	1	.8	4.8.3.3.1a
50	10	M18	.172	9.953	.006	14.219	293.914	780	79.873	1	.8	4.8.3.3.1a
51	11	M14	1.064	0	.023	0	10.309	278.5	11.483	.44	.4	4.8.3.3.1b
52	11	M15	.969	0	.023	0	10.309	278.5	11.483	.44	.432	4.8.3.3.1b
53	11	M16	.208	9.953	.006	0	293.914	780	79.873	1	.8	4.8.3.3.1a
54	11	M17	.297	9.953	.012	0	293.914	780	79.873	1	.8	4.8.3.3.1a
55	11	M18	.175	9.953	.006	0	293.914	780	79.873	1	.8	4.8.3.3.1a

Note:

- The [Member Detail Report](#) gives more values used to perform the code check.
- See [Spreadsheet Operations](#) to learn how to use **Find**, **Sort** and other options.
- See [Model Display Options – Members](#) to learn how to plot member results.
- See the code specific topics on the [Hot Rolled Steel - Design](#) page for additional restrictions / limitations.

Unity Check (UC) Results

The **UC Max** value represents the maximum Unity Check value produced by the interaction of the axial and bending stresses. This would be a factored ratio of actual to allowable stress, or demand vs capacity. The governing code equation that resulted in this value is displayed in the far right column for reference as well.

The **Shear UC** represents a similar ratio based on the shear provisions of the design code. The location for the shear check is followed by "y" or "z" to indicate the direction of the shear.

Generally, if UC Checks are less than 1.0, the member is considered passing. If either of them is greater than 1.0, the member is considered failing. If the value is greater than 9.999 it will be listed as "9.999".

The remaining columns, discussed below, provide some of the values used in the code check with the equation number itself given in the last column. The [Member Detail Report](#) gives more values used to perform the code check.

Location of the Governing Unity Check

The **Loc** field tells at what location the maximum code check occurs measured from the I-joint location (starting end) of the member. See [Model Display Options - Members](#) to learn how to view the code check results graphically.

Shear Capacity

The shear capacity, **Pv**, is calculated per section 4.2.3 using the listed equations for the shear area of each section type. Shear buckling per section 4.4.5 is also considered.

The reduction in design strength, "py", per table 9 in section 3.1.1 is automatically considered by the program. The reduction is based on the yield stress of the steel material used for the member and the maximum thickness of the cross section.

Compression Capacity

The compression capacity, **Pc** is calculated based on section 4.7. The effective lengths shown in table 22 are shown as "K" factors in the program (K*length is the effective length) and these can be approximated by the program based on the sway flags and the end release conditions of the member (the connection type is NOT considered.) The user can also specify the effective length by entering the appropriate [K factor](#).

For the case of a sway member having pinned ends, a value of 2.1 for K is used as table 22 does not address this condition. The program considers all H sections as I sections for purposes of picking the proper strut curve in table 23 in section 4.7.5. For the same table and section, the program does not do interpolation for shapes that have maximum thicknesses between 40 and 50 mm, per footnote 1.

Tension Capacity

The tension capacity, **Pt**, is calculated based on section 4.6 and currently done using the gross section.

Slenderness checks

Width to thickness checks are done for all shapes based on Tables 11 and 12 in section 3.5. Complete Effective section properties for the Area, Plastic Modulus, and Section Modulus, are done per section 3.5.6 and 3.6.

Moment Capacity

The moment capacity, **Mc**, is calculated per section 4.2.5, including consideration for the amount of shear at the section. The limit states of lateral torsional buckling, per section 4.3.6 and web buckling per section 4.4.4.2 are also considered.

Equivalent Uniform Moment Factors

The equivalent uniform moment factors (my, mz, mL_T) used in section 4.8.3 and shown in table 26 of section 4 are calculated automatically by the program based on the sway flag and member moment diagram. The user can also enter their own values.

Governing Equation

The final field lists the controlling equation for the code check. Combined axial and bending stresses are computed based on the equation shown in section 4.8, with the governing equation reported. Combined bending and warping is calculated per the AISC specification and design guide.

Biaxial bending and biaxial shears on Pipes and solid circular bars are done using the square root sum of the squares of the forces applied in or about the local y and local z directions.

Load Combination

For enveloped results the combination that produced the listed code and shear checks is given in the "LC" column. The other values are the corresponding values and are not necessarily the maximums across all the combinations.

EuroCode Code Check Results

Access the **Steel Code Check** spreadsheet by selecting the **Results** menu and then selecting **Members** ▶ **Steel Code Checks**.

LC	Member	Shape	UC Max	Loc [m]	Shear	Loc [m]	Nt.Rd [k]	Nl.Rd [k]	Mc.Rd [k]	Bm	Bm	EC3 Eqn
48	10	M16	.283	9.953	.006	0	254.497	709.091	72.612	1.3	1.8	EN5_5_4_3
49	10	M17	.406	9.953	.012	0	254.497	709.091	72.612	1.3	1.8	EN5_5_4_3
50	10	M18	.238	9.953	.006	14.219	254.497	709.091	72.612	1.3	1.344	EN5_5_4_3
51	11	M14	2.071	0	.025	0	9.242	253.182	11.284	1.255	1.255	EN5_5_4_2
52	11	M15	1.980	0	.025	0	9.242	253.182	11.284	1.204	1.204	EN5_5_4_2
53	11	M16	.285	9.953	.006	0	254.497	709.091	72.612	1.3	1.8	EN5_5_4_3
54	11	M17	.409	9.953	.012	0	254.497	709.091	72.612	1.3	1.8	EN5_5_4_3
55	11	M18	.241	9.953	.006	0	254.497	709.091	72.612	1.3	1.351	EN5_5_4_4

Note:

- The [Member Detail Report](#) gives more values used to perform the code check.
- See [Spreadsheet Operations](#) to learn how to use **Find**, **Sort** and other options.
- See [Model Display Options - Members](#) to learn how to plot member results.
- See the code specific topics on the [Hot Rolled Steel - Design](#) page for additional restrictions / limitations.

Unity Check (UC) Results

The **UC Max** value represents the maximum Unity Check value produced by the interaction of the axial and bending stresses. This would be a factored ratio of actual to allowable stress, or demand vs capacity. The governing code equation that resulted in this value is displayed in the far right column for reference as well.

The **Shear UC** represents a similar ratio based on the shear provisions of the design code. The location for the shear check is followed by "y" or "z" to indicate the direction of the shear.

Generally, if UC Checks are less than 1.0, the member is considered passing. If either of them is greater than 1.0, the member is considered failing. If the value is greater than 9.999 it will be listed as "9.999".

The remaining columns, discussed below, provide some of the values used in the code check with the equation number itself given in the last column. The [Member Detail Report](#) gives more values used to perform the code check.

Important Notes:

- The bending axes in the member local coordinate system are reversed between RISA and the Eurocode. All input and results are shown in the member local coordinate system used by RISA. For a wide flange shape, the “z-z” axis is parallel to the flanges and the “y-y” axis is parallel to the web.
- The reduction in yield strength, “fy”, per table 3.1 in section 3.2.2.1 is automatically considered by the program. The reduction is based only on the maximum thickness of the cross section. Yield strengths for sections with a maximum thickness of 40mm or less are not reduced. Yield strengths for sections with a maximum thickness greater than 40mm are reduced by 20 N/mm²

Location of the Governing Unity Check

The **Loc** field tells at what location the maximum code check occurs measured from the I-joint location (starting end) of the member. See [Model Display Options – Members](#) to learn how to view the code check results graphically.

Compressive Capacity

The compression capacity, **Nc.Rd** is calculated based on section 6.2.4 and 6.3.1. The effective lengths shown in tables E.2.1 and E.2.2 of the 1992 Eurocode are shown as “K” factors in the program (K*length is the effective length.) These can be approximated by the program based on the sway flags and the end release conditions of the member (the connection type is NOT considered.) The approximate K factor values for reasonable “pinned” and “fixed” conditions are taken from the British BS 5950-1:2000 code. The user can also specify the effective length by entering the appropriate [K factor](#). For the case of a sway member having pinned ends, a value of 2.1 for K is used as a reasonable limit.

Tension Capacity

The tension capacity, **Nt.Rd**, is calculated based on section 6.2.3 and currently done using the gross section.

Slenderness checks

Width to thickness checks are done for all shapes based on table 5.2 from the 2005 EuroCode.

Shear Capacity

The shear capacity, **Vpl.Rd**, is calculated per section 6.2.6 using the listed equations for the shear area of each section type. Shear buckling per section 5.6.3 of the 1992 Eurocode is also considered.

Moment Capacities

The moment capacity, **Mc.Rd**, is calculated per section 6.2.5, including consideration for the lateral-torsional buckling.

Equivalent Uniform Moment Factors

The equivalent uniform moment factors (Cm & CmLT per the 2005 code) are calculated per Table B.3 of Annex B unless they are manually input by the user in the [Member Design Properties](#) spreadsheet.

The equivalent uniform moment factors (β_m & β_{mLT} per the 1992 code) used in section 5.5.4 and shown in figure 5.5.3 of section 5.5.4 are calculated automatically by the program based on the sway flag and member moment diagram unless they are manually input by the user in the [Member Design Properties](#) spreadsheet.

Governing Equation

The final field lists the controlling equation for the code check. Combined axial and moment is checked for the limit state of stress and high shear, The limit states of flexural buckling and lateral torsional buckling as well as web buckling are also considered. The governing section is also reported. Combined bending and warping is calculated per the AISC specification and increases the moment about the y-y axis.

Biaxial bending and biaxial shears on Pipes and solid circular bars are done using the square root sum of the squares of the forces applied in or about the local axes.

Load Combination

For enveloped results the combination that produced the listed code and shear checks is given in the "LC" column. The other values are the corresponding values and are not necessarily the maximums across all the combinations.

Indian Code Check Results

Access the **Steel Code Check** spreadsheet by selecting the **Results** menu and then selecting **Members** ▶ **Steel Code Checks**.

	LC	Member	Shape	UC Max	Loc(ft)	Shear ...	Loc(ft)	Fa(ksi)	Ft(ksi)	Fb(ksi)	Cm	IN Eqn
35	7	M18	W12X53	.209	9.953	.006	0	11.425	30	33	1	IN7.1.1a
36	8	M14	W12X19	1.672	26.25	.021	26.25	1.16	30	5.213	.85	IN6.2
37	8	M15	W12X19	1.787	26.25	.021	26.25	1.16	30	5.213	.85	IN6.2
38	8	M16	W12X53	.227	9.953	.004	4.74	11.425	30	33	.6	IN7.1.1a
39	8	M17	W12X53	.365	9.953	.011	0	11.425	30	33	.6	IN7.1.1a
40	8	M18	W12X53	.233	9.953	.009	0	11.425	30	33	1	IN7.1.1a

Note:

- The [Member Detail Report](#) gives more values used to perform the code check.
- See [Spreadsheet Operations](#) to learn how to use **Find**, **Sort** and other options.
- See [Model Display Options - Members](#) to learn how to plot member results.
- See the code specific topics on the [Hot Rolled Steel - Design](#) page for additional restrictions / limitations.

Unity Check (UC) Results

The **UC Max** value represents the maximum Unity Check value produced by the interaction of the axial and bending stresses. This would be a factored ratio of actual to allowable stress, or demand vs capacity. The governing code equation that resulted in this value is displayed in the far right column for reference as well.

The **Shear UC** represents a similar ratio based on the shear provisions of the design code. The location for the shear check is followed by "y" or "z" to indicate the direction of the shear.

Generally, if UC Checks are less than 1.0, the member is considered passing. If either of them is greater than 1.0, the member is considered failing. If the value is greater than 9.999 it will be listed as "9.999".

The remaining columns, discussed below, provide some of the values used in the code check with the equation number itself given in the last column. The [Member Detail Report](#) gives more values used to perform the code check.

Location of the Governing Unity Check

The **Loc** field tells at what location the maximum code check occurs measured from the I-joint location (starting end) of the member. See [Model Display Options – Members](#) to learn how to view the code check results graphically.

Compressive Capacity

The allowable compressive stress, **F_a**, is calculated based on section 5.1. The effective lengths shown in table 5.2 are shown as “K” factors in the program ($K \times \text{length}$ is the effective length) and these can be approximated by the program based on the sway flags and the end release conditions of the member (the connection type is NOT considered.) The user can also specify the effective length by entering the appropriate [K factor](#). For the case of a sway member having pinned ends, a value of 2.1 for K is used as table 5.2 does not address this condition.

Tension Capacity

The allowable tensile stress, **F_t**, is calculated based on section 4.1 and is currently done using the gross section.

Slenderness Checks

The maximum slenderness ratios shown in table 3.1 are reported in the warning log when they are exceeded. The program still calculates capacities for the members and reports a code check.

Width to thickness checks are done for all shapes based on section 3.5.2.1. Complete effective section properties for the Area and Section Modulus are calculated.

Shear Capacity

The allowable shear stress, **F_v**, is used per section 6.4.1. This value is checked per the maximum shear stress in the section based on elastic theory.

Moment Capacity

The strong axis allowable bending stress, **F_b**, is calculated per section 6.2. The limit state of lateral torsional buckling, per sections 6.2.4 and 6.2.6, is considered. The allowable bending stress is increased per section 6.2.4.1 as appropriate. The weak axis bending stress is assigned per section 6.2.5.

Equivalent Uniform Moment Factor, C_m

The equivalent uniform moment factor, **C_m**, used in section 7.1 are calculated automatically by the program based on the sway flag per section 7.1.3. The user can also enter their own values in the [Member Design Parameters](#) spreadsheet.

Governing Equation

The final field lists the controlling equation for the code check. Combined axial and bending stresses are computed based on the equations shown in section 7.1, with the governing equation reported. Combined bending and warping is calculated per the AISC ASD specification.

Biaxial bending and biaxial shears on Pipes and solid circular bars are done using the square root sum of the squares of the forces applied in or about the local y and local z directions.

Load Combination

For enveloped results the combination that produced the listed code and shear checks is given in the "LC" column. The other values are the corresponding values and are not necessarily the maximums across all the combinations.

Australian Code Check Results

Access the **Steel Code Check** spreadsheet by selecting the **Results** menu and then selecting **Members** ▶ **Steel Code Checks**.

	L...	Member	Shape	UC Max	Loc [ft]	Shear UC	Loc [ft]	Phi*N [k]	Phi*N [k]	Phi*Mn [k-ft]	alpha_m	AS Eqn
1	1	M11	W12x19	.056	0	.004	0	9.425	250.65	25.913	2.5	AS8_4_4_1
2	1	M12	W12x19	.048	0	.004	0	9.425	250.65	25.99	2.5	AS8_4_4_1
3	1	M13	W12x53	.032	0	.003	0	262.915	702	104.322	1	AS8_4_2_2Y
4	1	M14	W12x53	.044	0	.004	0	262.915	702	102.98	1	AS8_4_2_2Y
5	1	M15	W12x53	.011	13.982	.001	0	262.915	702	104.75	1	AS8_4_2_2Y

Note:

- The [Member Detail Report](#) gives more values used to perform the code check.
- See [Spreadsheet Operations](#) to learn how to use **Find**, **Sort** and other options.
- See [Model Display Options - Members](#) to learn how to plot member results.
- See the code specific topics on the [Hot Rolled Steel - Design](#) page for additional restrictions / limitations.

Unity Check (UC) Results

The **UC Max** value represents the maximum Unity Check value produced by the interaction of the axial and bending stresses. This would be a factored ratio of actual to allowable stress, or demand vs capacity. The governing code equation that resulted in this value is displayed in the far right column for reference as well.

The **Shear UC** represents a similar ratio based on the shear provisions of the design code. The location for the shear check is followed by "y" or "z" to indicate the direction of the shear.

Generally, if UC Checks are less than 1.0, the member is considered passing. If either of them is greater than 1.0, the member is considered failing. If the value is greater than 9.999 it will be listed as "9.999".

The remaining columns, discussed below, provide some of the values used in the code check with the equation number itself given in the last column. The [Member Detail Report](#) gives more values used to perform the code check.

Location of the Governing Unity Check

The **Loc** field tells at what location the maximum code check occurs measured from the I-joint location (starting end) of the member. See [Model Display Options - Members](#) to learn how to view the code check results graphically.

Compressive Capacity

The allowable compressive stress, **Phi*N**, is calculated based on clause 6.3. The effective lengths shown in Figure 4.6.3.2 are shown as "K" factors in the program (K*length is the effective length) and these can be approximated by the program based on the sway flags and the end release conditions of the member (the

connection type is NOT considered.) The user can also specify the effective length by entering the appropriate [K factor](#).

Tension Capacity

The allowable tensile stress, $\Phi * N_t$, is calculated based on clause 7.2 and is currently done using the gross section.

Slenderness Checks

Width to thickness checks are done for all shapes based on Table 5.2. Complete effective section properties for the Area and Section Modulus are calculated.

Shear Capacity

The allowable shear stress, $\Phi * V_v$, is used per clause 5.11. This value is checked per the maximum shear stress in the section based on elastic theory.

Moment Capacity

The strong axis allowable bending stress, $\Phi * M_n$, is calculated per section 5. The limit state of lateral torsional buckling, per clause 5.6 is considered.

Moment Modification Factor, α_m

The moment modification factor, α_m , is calculated automatically by the program based on clause 5.6.1.1. When explicit unbraced lengths are used, the program does not have the member segment information to calculate α_m . It will conservatively assume α_m to be 1.0. The user can also enter their own values in the [Member Design Parameters](#) spreadsheet.

Governing Equation

The final field lists the controlling equation for the code check. Combined axial and bending stresses are computed based on the equations shown in clause 8.4, with the governing equation reported. Combined bending and warping is calculated per the AISC ASD specification.

Biaxial bending and biaxial shears on Pipes and solid circular bars are done using the square root sum of the squares of the forces applied in or about the local y and local z directions.

Load Combination

For enveloped results the combination that produced the listed code and shear checks is given in the "LC" column. The other values are the corresponding values and are not necessarily the maximums across all the combinations.

New Zealand Code Check Results

Access the **Steel Code Check** spreadsheet by selecting the **Results** menu and then selecting **Members ▶ Steel Code Checks**.

Hot Rolled Steel Cold Formed Steel Wood Concrete Beams Concrete Columns Aluminum												
	LC	Member	Shape	UC Max	Loc[ft]	Shear UC	Loc[ft]	Phi*N[k]	Phi*Nt[k]	Phi*Mn...	alpha_m	NZS Eqn
1	1	M11	W12x19	.056	0	.004	0	9.425	250.65	25.913	2.5	NZ8_4_4_1
2	1	M12	W12x19	.048	0	.004	0	9.425	250.65	25.99	2.5	NZ8_4_4_1
3	1	M13	W12x53	.032	0	.003	0	262.915	702	104.322	1	NZ8_4_2_2Y
4	1	M14	W12x53	.044	0	.004	0	262.915	702	102.98	1	NZ8_4_2_2Y
5	1	M15	W12x53	.011	13.982	.001	0	262.915	702	104.75	1	NZ8_4_2_2Y

Note:

- The [Member Detail Report](#) gives more values used to perform the code check.
- See [Spreadsheet Operations](#) to learn how to use **Find**, **Sort** and other options.
- See [Model Display Options - Members](#) to learn how to plot member results.
- See the code specific topics on the [Hot Rolled Steel - Design](#) page for additional restrictions / limitations.

Unity Check (UC) Results

The **UC Max** value represents the maximum Unity Check value produced by the interaction of the axial and bending stresses. This would be a factored ratio of actual to allowable stress, or demand vs capacity. The governing code equation that resulted in this value is displayed in the far right column for reference as well.

The **Shear UC** represents a similar ratio based on the shear provisions of the design code. The location for the shear check is followed by "y" or "z" to indicate the direction of the shear.

Generally, if UC Checks are less than 1.0, the member is considered passing. If either of them is greater than 1.0, the member is considered failing. If the value is greater than 9.999 it will be listed as "9.999".

The remaining columns, discussed below, provide some of the values used in the code check with the equation number itself given in the last column. The [Member Detail Report](#) gives more values used to perform the code check.

Location of the Governing Unity Check

The **Loc** field tells at what location the maximum code check occurs measured from the I-joint location (starting end) of the member. See [Model Display Options - Members](#) to learn how to view the code check results graphically.

Compressive Capacity

The allowable compressive stress, **Phi*N**, is calculated based on clause 6.3. The effective lengths shown in Figure 4.6.3.2 are shown as "K" factors in the program (K*length is the effective length) and these can be approximated by the program based on the sway flags and the end release conditions of the member (the connection type is NOT considered.) The user can also specify the effective length by entering the appropriate [K factor](#).

Tension Capacity

The allowable tensile stress, **Phi*Nt**, is calculated based on clause 7.2 and is currently done using the gross section.

Slenderness Checks

Width to thickness checks are done for all shapes based on Table 5.2. Complete effective section properties for the Area and Section Modulus are calculated.

Shear Capacity

The allowable shear stress, $\Phi \cdot V_v$, is used per clause 5.11. This value is checked per the maximum shear stress in the section based on elastic theory.

Moment Capacity

The strong axis allowable bending stress, $\Phi \cdot M_n$, is calculated per section 5. The limit state of lateral torsional buckling, per clause 5.6 is considered.

Moment Modification Factor, α_m

The moment modification factor, α_m , is calculated automatically by the program based on clause 5.6.1.1. The user can also enter their own values in the [Member Design Parameters](#) spreadsheet.

Governing Equation

The final field lists the controlling equation for the code check. Combined axial and bending stresses are computed based on the equations shown in clause 8.4, with the governing equation reported. Combined bending and warping is calculated per the AISC ASD specification.

Biaxial bending and biaxial shears on Pipes and solid circular bars are done using the square root sum of the squares of the forces applied in or about the local y and local z directions.

Load Combination

For enveloped results the combination that produced the listed code and shear checks is given in the "LC" column. The other values are the corresponding values and are not necessarily the maximums across all the combinations.

Tapered Member Results

The spreadsheet results for tapered members gives the same information as other [AISC Code Checks](#). However, the Detail Reports for tapered members designed to *AISC Design Guide 25* give some additional information.

As shown in the image below, the code checks list the member capacity calculated for axial, flexure, and shear. In addition to the capacity values, the table reports the equation number used to arrive at that capacity and the failure mode which caused it (please see the example below). The table also gives the slenderness parameters that apply for that failure state.

	Elastic Limit	Plastic Limit	Slender Ratio	Gov Eqn
Pnc/om 66.99 k	2.25	na	1.02	E7-2 (CAT)
Mny/om 7.98 k-ft	15.43	8.73	13.7	F6-2
Mnz/om 59.14 k-ft	15.43	8.73	13.7	F4-12 (FLB)
Rpc 1	130.89	62.13	145.32	F4-9
Rpg .99	130.89		145.32	F5-6
Vny/om 13.37 k	56.48	70.34	96	G2-5
Fy 55 ksi				
Pnt/om 172.42 k				
Vnz/om 63.08 k				

The following failure modes are listed for axial and strong axis bending:

- **(z-z)** : In-Plane or Strong Axis flexural buckling of the member due to axial force.
- **(z-z)** : Out-of-Plane or Weak Axis flexural buckling of the member due to axial force.
- **TB** : Torsional buckling of the member due to axial force.
- **FTB** : Flexural Torsional Buckling of the member due to axial force.
- **CAT** : Constrained Axis Torsional Buckling of the member due to axial force.
- **FLB** : Flange Local Buckling due to flexure.
- **WLB** : Web Local Buckling.
- **TFY** : Tension Flange Yielding due to flexure.
- **CFY** : Compression Flange Yielding due to flexure.
- **LTB** : Lateral Torsional Buckling of the member due to flexure.

Please see the Tapered Member [design](#) topic for more information about these limit states.

Joints

Joints are used to define the ends of members and plate corners. Joints are also used to specify boundary conditions, story drift locations, and joint loads. Each joint is a point in space defined by coordinates in the global X and Y directions and temperature that may be used in conjunction with thermal loads.

Note

- The terms "node" and "joint" are interchangeable and are both used in this manual and in the program.

Joints may be input manually, or they may be created automatically as you draw new members and plates on the drawing grid. Once defined, the joints may be edited in three ways: graphically, in the **Joint Information Dialog**, or in the **Joint Coordinates Spreadsheet**.

To Define Joints

- Select the **Joint Coordinates Spreadsheet** from the **Spreadsheets Menu** and define the joint coordinates and temperature.

Note

- You may use cut and paste, block fill, and block math to enter and edit joints.
- You may choose the prefix that is used to label the joints.
- To modify one joint you may double click that joint to view and edit its properties.

To Relabel Joints

- After sorting the **Joints Spreadsheet** into the desired order select the **Tools Menu** and choose **Relabel Joints**.

Rounding Off Joint Coordinates

- Select the **Tools Menu** and choose **Round Off Joint Coordinates**.

Note

- This utility will round off all the joint coordinates to 1, 2, or 3 decimal places (user selected). This sometimes is useful for models that have been generated or created via DXF import and have joint coordinates with a large number of decimal places that aren't significant. Rounding off those coordinates makes the data more consistent and can help avoid problems such as non-coplanar plate/wall joints. Also, the default member orientations can change based on whether the member is exactly parallel to a global axis and slight unintended coordinate differences can have an impact here as well.

Joint Coordinates Spreadsheet

The **Joint Coordinates Spreadsheet** records the joint coordinates and ambient temperatures for the joints and may be accessed by selecting **Joint Coordinates** on the **Spreadsheets Menu**.

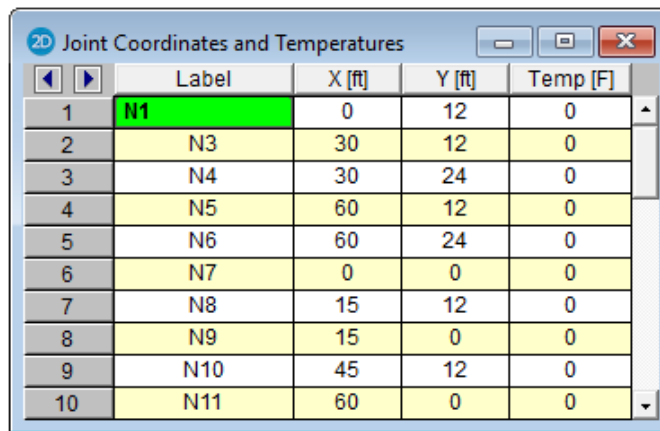

	Label	X [ft]	Y [ft]	Temp [F]
1	N1	0	12	0
2	N3	30	12	0
3	N4	30	24	0
4	N5	60	12	0
5	N6	60	24	0
6	N7	0	0	0
7	N8	15	12	0
8	N9	15	0	0
9	N10	45	12	0
10	N11	60	0	0

The first column is used to assign a unique **Label** to every joint. You can then refer to the joint by its label. Each label has to be unique, so if you try to enter the same label more than once you will receive an error message. As you create new lines, the program will automatically create a new, unique label for each joint.

The next two columns contain the coordinates of the joint in each of the global directions. These represent the relative offsets of the joints from the origin of the coordinate system (0, 0). The appropriate units are listed at the top of each column.

The next column is used to define the ambient, no-stress, temperature at the joint. Temperature loads are then calculated based on the differential between the ambient temperature interpolated across the member, and the applied thermal load. See [Loads - Thermal Loads](#) for more information.

Two options on the **Tools Menu** help you work with joints. Selecting **Relabel Joints** will let you define a prefix to be used for the joint labels before creating a new label for each joint by using this prefix with a sequential number. For example, if you were to enter a prefix of "FLR", the first joint would get label FLR1, the second one would get FLR2, etc.

The second option is **Round Off Joint Coordinates**. Selecting this will round off all the joint coordinates to 1, 2, or 3 decimal places. This is useful for models that have been created using generation functions or DXF files where a high number of decimal places is present for some of the coordinates.

Joint Information Dialog

Just as with the members and plates you may double-click any joint to view its properties. All of the same information that is stored in the **Joints** spreadsheet is displayed for the joint you choose, and may be edited. This is a quick way to view and change joint properties. For large selections of joints however the spreadsheet and graphic editing tools may be the faster solution.

Label - You can view and edit the joint's label.

Temperature - Allows you to set the ambient temperature at that node for [Thermal Loading](#).

Coordinates - You can view and edit the joint coordinates.

Boundary Conditions - Here you can view and edit the joint boundary conditions. The edit boxes to the right of the boundary condition list boxes are where you would enter additional data for a boundary condition such as a spring stiffness, a Story number, or a Primary joint label for a Tethered joint.

Note

- It's generally more efficient to use the Graphic Editing features if you want to change the properties for many joints at once.

Joints - Results

When the model is solved, there are several groups of results specifically for the joints. Story Drift calculation results are discussed in [Drift Results](#), the others are discussed here.

Joint Deflections Results

Access the **Joint Deflections Spreadsheet** by selecting it from the **Results Menu**.

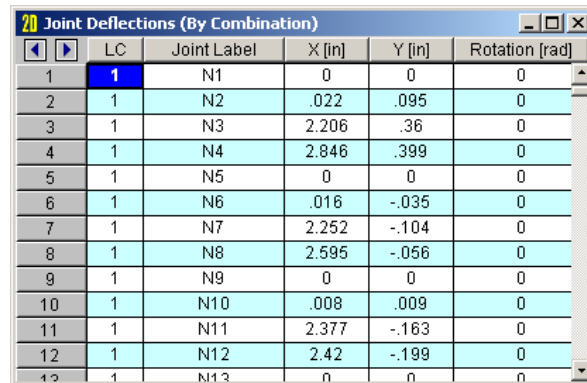

	LC	Joint Label	X [in]	Y [in]	Rotation [rad]
1	1	N1	0	0	0
2	1	N2	.022	-.095	0
3	1	N3	2.206	.36	0
4	1	N4	2.846	-.399	0
5	1	N5	0	0	0
6	1	N6	.016	-.035	0
7	1	N7	2.252	-.104	0
8	1	N8	2.595	-.056	0
9	1	N9	0	0	0
10	1	N10	.008	.009	0
11	1	N11	2.377	-.163	0
12	1	N12	2.42	-.199	0
13	1	N13	0	0	0

These are the deflections, or displacements, for every joint in the structure. Each joint has 3 values calculated, 1 for each of the 3 global degrees of freedom. Those being 2 translations and 1 rotations. The units for the displacements are shown at the top of each column. The rotations are shown in units of radians (1 radian = 57.3 degrees, approximately).

For enveloped results the maximum and minimum value for each displacement is listed. The load combination producing the maximum or minimum is also listed, in the "lc" column. To include a particular Load Combination in the envelope analysis, open the **Load Combinations Spreadsheet** and check the box in the **Solve** column.

The moving load results are enveloped and will display the Load Combinations with maximum and minimum values shown for each section location, for each active member. The governing load combination and step location is shown for each result value under the "LC" column. The first number is the load combination, the second is the step number: (load combination - step number). See [Moving Loads](#) to learn more.

Note

- See [Spreadsheet Operations](#) to learn how to use **Find**, **Sort**, and other options.
- See [Model Display Options - Joints](#) to learn how to plot joint results. You will NOT be able to plot the deflected shape for an envelope analysis. This is because the various maximum and minimum displacements probably correspond to different load combinations, so a deflected shape based on these values would be meaningless.
- You can see the deflection results for a joint in any model view by moving your mouse near the joint and then reading the deflection results from the right hand section of the status bar. The joint displacement reported will coincide with the joint nearest to the tip of the mouse pointer.

Joint Reaction Results

Access the **Joint Reactions Spreadsheet** by selecting it from the **Results Menu**.

	L...	Joint Label	X [k]	Y [k]	MZ [k-ft]
1	1	N1	0	-.334	0
2	1	N3	0	3.552	0
3	1	N5	0	2.32	0
4	1	Totals:	0	5.538	
5	1	COG (ft):	X: 15.63	Y: 7.891	

These are the reactive forces **applied to the structure** at its points of support. A positive reaction is applied in the direction of the global axis and a negative reaction is applied in the direction opposite the global axis. A positive moment is given according to the right hand rule assuming the thumb is pointing in the positive global axis direction. Assuming a reaction has been calculated at all points of support, the total of the reactive forces in each direction should equal the total applied force in each direction. The units for the reactions are listed at the top of each column, and a total reaction for each direction is summed at the bottom of each translation column.

Wall Panel Reactions represent the total reactions for the wall about the bottom center of the wall. This location does not change even if the center of the wall is within an opening, or if the edge of the wall is restrained as well as the base.

The last line provides the center of gravity (COG) for the applied loads. This "COG" is based on the load components acting in the VERTICAL direction. If there are no vertical loads in the combination a "COG" will not be calculated.

For enveloped results the maximum and minimum reaction value is listed. The load combination producing the maximum or minimum is also listed, in the "LC" column.

The moving results loads are enveloped and will display the Load Combinations with maximum and minimum values shown for each section location, for each active member. The governing load combination and step location is shown for each result value under the "LC" column. The first number is the load combination, the second is the step number: (load combination - step number). See [Moving Loads](#) to learn more.

Note

- See [Spreadsheet Operations](#) to learn how to use **Find**, **Sort**, and other options.
- See [Model Display Options - Joints](#) to learn how to plot joint results.
- An 'NC' listing means "No Calculation". This occurs for boundary conditions defined with the 'Fixed' option and joints with an enforced displacement in that degree of freedom.

Joints - Tethering Joints

When a node is "tethered", it is linked in one or more directions to other nodes (the "Primary" node). Both nodes (Tethered and Primary) actually share the same degree of freedom for the direction of tethering. The tethering can be for any or all of the three global degrees of freedom. A node can be tethered to more than one node (in different directions). Any number of nodes may be tethered to the same primary node, but the primary node itself may not be tethered to another node.

Note:

- Since the advent of [rigid links](#) there are not many circumstances where nodal tethering is the best solution for modeling.

An example of the use of nodal tethering is in X bracing, where the bracing members overlay and are pinned to each other. Modeling this connection makes the analysis far more complex than simply modeling the braces as separate pieces, and is **generally not recommended**. However, if it is desired to specifically account for interaction between the braces then this pinning will force the brace midpoints to deflect together for translations, but still leave them free to rotate independently.

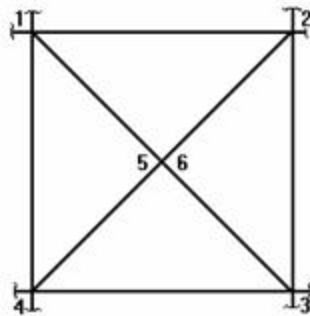

In this diagram the braces are NOT modeled as physical members. Brace 1 to 3 is modeled with non physical members from nodes 1 to 5 and 5 to 3. Brace 2 to 4 is modeled with non physical members from nodes 2 to 6 and 6 to 4. Nodes 5 and 6 are at the same location where the braces overlap and are pinned together.

We would tether node 6 to node 5 for the translation directions. To define a tethered node, use the **Boundary Conditions** spreadsheet. Enter the label of the node to be tethered as the "Node No.", and for the directions in which it is tethered, enter **TETHER nnn**, where **nnn** is the label of the primary node.

For this X brace example, we would enter the following on the **Boundary Conditions** spreadsheet:

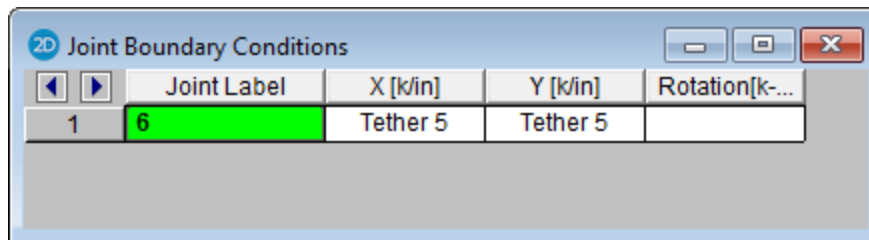

Here we have "TETHER 5" entered for the X, and Y translations. The rotation field is left blank because node 6 is free to rotate independently. We don't have to enter anything for node 5.

Loads

As you input loads they are grouped into separate sets of [Basic Load Cases](#). These are the basic building blocks of the loads applied to the structure, consisting of discrete loads and self-weight of the structure. The basic load cases may also be grouped into load categories such as dead load and live load. In the end, the model will be solved against load combinations that are built with the basic load cases and categories.

You may view the loads on your model. This is an excellent way to verify the loads that are on the model. You may plot them by load case, load category or load combination. See [Model Display Options – Loads](#) to learn how to do this.

Each of the discrete load types is described in it's own section:

- [Distributed Loads](#)
- [Joint Loads/Forced Displacements](#)
- [Moving Loads](#)
- [Point Loads](#)
- [Thermal Loads](#)

Self Weight (Gravity Load)

The structure's self-weight may be automatically calculated and included in a solution. The inclusion of self-weight may be specified within a Basic Load Case or as part of a Load Combination.

The self-weight is calculated as a full-length uniform load across each member of the model. The magnitude of the load is the area times the material weight density.

Note

- If a member has offsets defined, the offset distances are not included in the self-weight calculation.

Adding Self Weight to a Basic Load Case

- Select the **Basic Load Case** spreadsheet from the **Spreadsheets** menu. On the line of the load case you wish to contain self-weight, enter a load factor in the appropriate direction column. For example, if you wish to apply 90% of the self-weight in the negative Y direction (down), you would put -0.9 as the factor in the **Y Gravity** column.

Adding Gravity Load to a Load Combination

- To include the self-weight in a Load Combination, put "X" or "Y" in the BLC field. The letter used indicates which global direction the self-weight is applied in. Also put a factor in the Factor field. For example, if you wish to apply 90% of the self-weight in the negative Y direction (down), you would put "Y" as the BLC and "-0.9" as the BLC factor.

Note

- You may have multiple self-weight definitions, i.e. you could have self-weight applied in the "Y" and "X" directions in the same or different load cases if you wished.
- Don't inadvertently include the self-weight of the structure twice by specifying it within a combination that includes a Basic Load Case that also contains the self-weight.

Drawing Loads

You may graphically apply loads to the model. You may apply one load at a time by clicking the mouse, or apply loads to entire selections at once. All of the graphical loading tools may be found on the **Drawing Toolbar**.

Modifying Loads

Modifying loads may be done within the spreadsheets. Select **Loads** from the **Spreadsheets** menu and then choose the spreadsheet that you wish to modify. You may then move through different Basic Load Cases by using the drop-down list on the **Window Toolbar**.

See [Spreadsheet Operations](#) to learn how you can modify the loads. You may also copy or delete entire Basic Load Cases from the **Basic Load Case** spreadsheet. See [Copying Basic Load Cases](#) and [Deleting Basic Load Cases](#) for more information.

Deleting Loads

Deleting loads may be done within the spreadsheets. Select **Loads** from the **Spreadsheets** menu and then choose the spreadsheet that you wish to modify. You may then move through different Basic Load Cases by using the drop-down list on the **Window Toolbar**.

You may use spreadsheet operations such to help modify the loads. You may also delete entire Basic Load Cases from the **Basic Load Case** spreadsheet. See [Deleting Basic Load Cases](#).

Loads - Basic Load Cases

When loads are defined they are grouped into basic load cases (BLC's). You are allowed up to 1000 separate Basic Load Cases. These are the basic building blocks of the final load combinations applied to the structure. The basic load cases may be assigned to load categories such as dead load and live load. These basic cases and categories are then combined to define load combinations used in analysis. A BLC can be comprised of any type of load, such as joint loads, distributed loads, member point loads, etc.

Any time you are applying or viewing loads, graphically or in the spreadsheets, they are assigned to the current basic load case. The current basic load case is displayed in the **Window Toolbar** in a drop down list. To change to another BLC simply choose it from this list. If you wish to change the name the BLC's you may do this in the **Basic Load Case** spreadsheet.

To Add Loads to a Basic Load Case

- When adding loads graphically click on the toolbar button for the type of load you wish to add and specify the BLC along with the load definition.
- When adding loads with the spreadsheets, open the spreadsheet for the load type you want to add and select the BLC from the list on the Window Toolbar.

Basic Load Case Spreadsheet

The **Basic Load Cases** spreadsheet groups and summarizes the loads applied to the model and may be accessed by selecting **Basic Load Cases** on the **Spreadsheets** menu.

	BLC Description	Category	X Gravity	Y Gravity	Joint	Point	Distrib...
1	SelfWeight	DL		-1			
2	Superimposed Dead	DL					5
3	Live Load	LL					5
4	Snow Load	SL					6
5	Wind Load	WL					9
6		None					

Information about Basic Load Cases (BLC's) is recorded on the **Basic Load Case Spreadsheet** and the loads themselves are recorded in the load spreadsheets for each load type.

You may enter descriptions for each BLC in the first column. These descriptions are primarily for your own use. The descriptions will print as part of the input printout and you can also display the description when plotting the loads for the BLC or choosing them from the list.

The second column is used to assign the BLC to a load category such as Dead Load or Live Load. Simply choose the category from the drop down list. You can then build load combinations for analysis by referring to the categories rather than list each basic load case.

The next two columns may be used to specify that the self-weight of the structure be included in a load case. Simply enter a factor in the column that represents the direction of the self-weight. Typically you will enter a value of "-1" in the **Y Gravity** column assuming that Y is the vertical axis.

The remaining columns display the quantity of each type of load that is contained in the BLC. You may not edit these values **but you may click on the quantities to open the spreadsheet and view the loads that it represents**. For example, the previous figure has 5 distributed loads as part of BLC 2. Clicking on the number 5 with the mouse will open the Distributed Loads spreadsheet and display these loads.

Copying Basic Load Cases

You may copy the loads from one BLC into another BLC. This can be useful when one load case is similar to another and can be entered quickly by copying a load case and then making changes to the copy with features such as block math.

To do this, open the **Basic Load Case** spreadsheet and then click . Specify what case to copy loads from and which case the loads are to be copied into. You may further specify which types of loads are to be copied. For example, if you check **Joint Loads** and uncheck all the other load types, only the joint loads will be copied.

Any loads copied into a BLC will be added to any loads that may already be in that BLC.

Deleting Basic Load Cases

You may automatically clear all the loads in a BLC. To do this, open the **Basic Load Case** spreadsheet and then click the **Delete BLC**  button on the **Window** toolbar. Select the BLC you wish to delete.

All of the loads will be deleted including category information and any self-weight information. The BLC Description will remain in the **Description** field.

Load Categories

The basic load cases may be assigned to load categories, such as dead load and live load, which are commonly used in building codes. You may do this on the **Basic Load Cases** spreadsheet. These categories may then be combined to define load combinations used in analysis.

Categories are easy to use and are very helpful. They allow you to place your loads into groups that are commonly used in load combinations, while keeping them in separate load cases. This is especially helpful in large models where the loads might occupy many different load cases. They also allow you to define load combinations that are easily understood because they resemble the combinations as they appear in the building code.

Load Category	Description
DL	Dead Load
LL	Live Load
EL	Earthquake Load
WL	Wind Load
SL	Snow Load
RLL	Roof Live Load
LLS	Live Load Special (public assembly, garage, storage, etc.)
TL	Long Term Load (creep, shrinkage, settlement, thermal, etc.)
SLN	Snow Load Non-shedding
HL	Hydrostatic Load
FL	Fluid Pressure Load
RL	Rain Load
PL	Ponding Load
EPL	Earth Pressure Load
IL	Impact Load
OL1 - OL100	Other Load 1 - 100 (generic)
ELX, ELY, ELZ	Earthquake Load along global X-axis, Y-axis, Z-axis
WLX, WLY, WLZ	Wind Load along global X-axis, Y-axis, Z-axis
WL+X, WL+Y, WL+Z	Wind Load along positive global X-axis, Y-axis, Z-axis
WL-X, WL-Y, WL-Z	Wind Load along negative global X-axis, Y-axis, Z-axis
WLXP1, WLYP1, WLZP1	Partial Wind Load 1 along global X-axis, Y-axis, Z-axis
WLXP2, WLYP2, WLZP2	Partial Wind Load 2 along global X-axis, Y-axis, Z-axis
ELX+Z, ELX+Y	Eccentric Earthquake Load along global X-axis shifted along positive global Z-axis, Y-axis
ELX-Z, ELX-Y	Eccentric Earthquake Load along global X-axis shifted along negative global Z-axis, Y-axis
ELZ+X, ELZ+Y	Eccentric Earthquake Load along global Z-axis shifted along positive global X-axis, Y-axis
ELZ-X, ELZ-Y	Eccentric Earthquake Load along global Z-axis shifted along negative global X-axis, Y-axis
ELY+X, ELY+Z	Eccentric Earthquake Load along global Y-axis shifted along positive global X-axis, Z-axis
ELY-X, ELY-Z	Eccentric Earthquake Load along global Y-axis shifted along negative global X-axis, Z-axis
NL, NLX, NLY, NLZ	General notional load and along global X-axis, Y-axis, Z-axis
WLX+R, WLY+R, WLZ+R, WLX-R, WLY-R, WLZ-R,	Roof wind loads in the positive and negative X-axis, Y-axis, Z-axis

Using categories is optional. Remember though that if you define combinations of categories you must define these categories in the **Basic Load Case** spreadsheet. If you don't, the combinations will have no loads.

Loads - Load Combinations

During solution the model is loaded with a combination of factored Load Categories and/or Basic Load Cases, both of which are defined on the **Basic Load Cases Spreadsheet**. These combinations, load factors, and other parameters are defined on the **Load Combinations Spreadsheet**. Most standard load combinations are included in the program. See [Solution](#) to learn how to solve load combinations.

To Add Load Combinations Manually

1. From the **Spreadsheets Menu** select **Load Combinations**.
2. Enter load combinations by pairing loads in the **BLC** fields with factors in the **Factor** fields.



To Add Auto-Generated Building Code Combinations

1. From the **Spreadsheets Menu** select **Load Combinations**.
2. Select the **LC Generator** button from the **Window Toolbar**.
3. Select the Load Combination **Region** and **Code** from the drop down lists provided in the Gravity tab.
4. Modify the generated combinations and options in the spreadsheet as necessary.

Note

- The generated building code combinations are made up of Load Categories and Factors. Loads that are not assigned to these categories will not be included in the combinations upon solution.
- All generated combinations are added and marked for the envelope solution. You may remove combinations from the envelope after adding them.
- You may specify P-Delta options and SRSS combinations for each combination after you have added them.
- Verify the Wind/Seismic ASIF (allowable stress increase factor), the Footing ABIF (allowable bearing increase factor), and the Timber CD settings on the **Design** tab for combinations after you add them.
- You may save any preferred load combinations as the default by clicking the **Save As Defaults**  button on the **Window Toolbar**.

To Solve Load Combinations

- To solve a single load combination, click the **Solve**  button on the **RISA Toolbar**. Select the load combination from the drop down list and click the **Solve** button.
- To solve multiple load combinations, first mark the combinations to be solved by checking the **Solve** box on the **Load Combinations** spreadsheet. Click the **Solve**  button on the **RISA Toolbar**, and choose the **Envelope** or **Batch** option before clicking **Solve**.

Note

- The **Envelope** solution is where all combinations with a checkmark in the **Solve** field are solved simultaneously. The **Maximum and Minimum** results of these solutions are listed, along with the number of the controlling load combination for each solution result.
- The **Batch** solution is where all combinations with a checkmark in the **Solve** field are solved simultaneously. **All** results of these solutions are listed.

Load Combinations Spreadsheet

The **Load Combinations Spreadsheet** records the combinations of loads for solution and may be accessed by selecting **Load Combinations** on the **Spreadsheets Menu**.

	Description	Solve	PDelta	SRSS	BLC	Factor	BLC	Factor	BLC	Factor	BLC	Factor	BLC	Factor	BLC	Factor
7	ASCE 1	<input checked="" type="checkbox"/>			DL	1.4										
8	ASCE 2 (a)	<input checked="" type="checkbox"/>			DL	1.2	LL	1.6	LLS	1.6	RLL	.5				
9	ASCE 2 (b)	<input checked="" type="checkbox"/>			DL	1.2	LL	1.6	LLS	1.6	SL	.5				
10	ASCE 2 (c)	<input checked="" type="checkbox"/>			DL	1.2	LL	1.6	LLS	1.6	RL	.5				
11	ASCE 3 (a)	<input checked="" type="checkbox"/>			DL	1.2	RLL	1.6	LL	.5	LLS	1				
12	ASCE 3 (b)	<input checked="" type="checkbox"/>			DL	1.2	RLL	1.6	WL	.8						
13	ASCE 3 (c)	<input checked="" type="checkbox"/>			DL	1.2	RLL	1.6	WL	-.8						
14	ASCE 3 (d)	<input checked="" type="checkbox"/>			DL	1.2	SL	1.6	LL	.5	LLS	1				
15	ASCE 3 (e)	<input checked="" type="checkbox"/>			DL	1.2	SL	1.6	WL	.8						
16	ASCE 3 (f)	<input checked="" type="checkbox"/>			DL	1.2	SL	1.6	WL	-.8						
17	ASCE 3 (g)	<input checked="" type="checkbox"/>			DL	1.2	RL	1.6	LL	.5	LLS	1				

Combinations Tab

The first field, the **Description**, is strictly for the user's reference. Enter any descriptive label you wish and it may be displayed with the results when the combination is solved.

The next three fields are for options that apply to each load combination.

The **Solve** box is used to indicate which combinations should be included in batch or envelope solutions. See [Solution](#) for more information.

The **P-Delta** entry is used to enable an analysis of member secondary effects. See [P-Delta Analysis](#) for more information.

Note

- Per Section C1 of Chapter C (Design for Stability) of the AISC 15th Edition steel code, a factor of 1.6 will be applied to all load combinations for which a P-Delta analysis is to be performed (and for which the Hot Rolled box is checked on the Design tab) whenever 'AISC 15th: ASD' is selected on the Codes tab of the Model Settings Dialog. This factor is applied prior to conducting the P-Delta analysis and the results are subsequently divided by a factor of 1.6.

The **SRSS** entry is used to combine response spectra results by the Square Root of Sum of Squares. See [SRSS Combination of RSA Results](#) for more information.

The next eight pairs of fields (**BLC, Factor**) are for defining what loads are to be part of the combination, along with factors for each. Select load categories from the drop down lists in the **Category** columns of the spreadsheet. The following are the entries you can use in the **BLC** field:

Entry	Description
Number	Entering a number includes that particular Basic Load Case, I.e. enter "3" for BLC 3
Category	Enter a category code such as DL, LL, etc to include all loads in that category
Lnn	Enter "Lnn" to nest the loads from another combination, where "nn" is the number of the other combination, i.e. "L3" means include all loads from load combination 3.
Mnn	Use this entry to include a moving load where "Mnn" is the moving load tag from the moving load spreadsheet
Sn	Includes response spectra results for the global direction "n", I.e. enter "SX" to include response spectra results calculated in the global X direction, "SY" for global Y, etc.
Tn	Use this entry to include a time history load where "Tn" is the time history load tag from the Time History Loads spreadsheet

Enter in the **Factor** field a multiplier to be applied to the loads being included.

You may also use the  button in the BLC cell to help you specify the loads. Choose from load categories, basic load cases, or spectral results or moving loads from the drop-down lists.

Design Tab

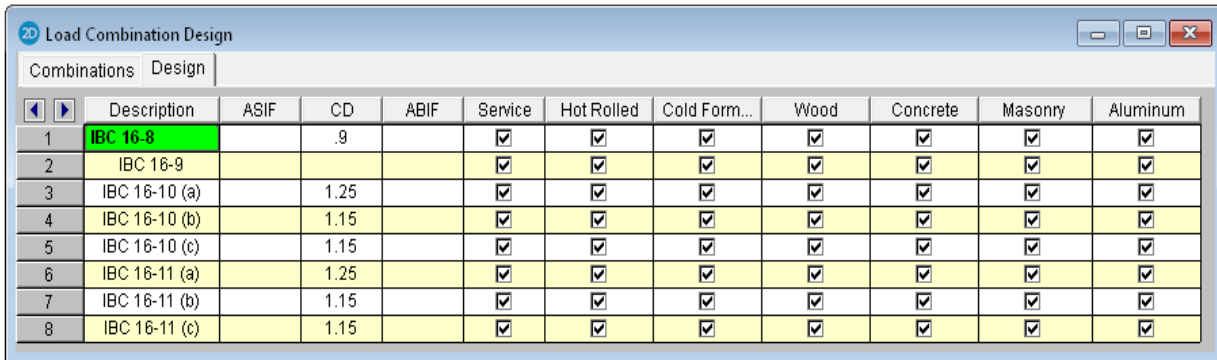

	Description	ASIF	CD	ABIF	Service	Hot Rolled	Cold Form...	Wood	Concrete	Masonry	Aluminum
1	IBC 16-8		.9		<input checked="" type="checkbox"/>	<input checked="" type="checkbox"/>	<input checked="" type="checkbox"/>	<input checked="" type="checkbox"/>	<input checked="" type="checkbox"/>	<input checked="" type="checkbox"/>	<input checked="" type="checkbox"/>
2	IBC 16-9				<input checked="" type="checkbox"/>	<input checked="" type="checkbox"/>	<input checked="" type="checkbox"/>	<input checked="" type="checkbox"/>	<input checked="" type="checkbox"/>	<input checked="" type="checkbox"/>	<input checked="" type="checkbox"/>
3	IBC 16-10 (a)		1.25		<input checked="" type="checkbox"/>	<input checked="" type="checkbox"/>	<input checked="" type="checkbox"/>	<input checked="" type="checkbox"/>	<input checked="" type="checkbox"/>	<input checked="" type="checkbox"/>	<input checked="" type="checkbox"/>
4	IBC 16-10 (b)		1.15		<input checked="" type="checkbox"/>	<input checked="" type="checkbox"/>	<input checked="" type="checkbox"/>	<input checked="" type="checkbox"/>	<input checked="" type="checkbox"/>	<input checked="" type="checkbox"/>	<input checked="" type="checkbox"/>
5	IBC 16-10 (c)		1.15		<input checked="" type="checkbox"/>	<input checked="" type="checkbox"/>	<input checked="" type="checkbox"/>	<input checked="" type="checkbox"/>	<input checked="" type="checkbox"/>	<input checked="" type="checkbox"/>	<input checked="" type="checkbox"/>
6	IBC 16-11 (a)		1.25		<input checked="" type="checkbox"/>	<input checked="" type="checkbox"/>	<input checked="" type="checkbox"/>	<input checked="" type="checkbox"/>	<input checked="" type="checkbox"/>	<input checked="" type="checkbox"/>	<input checked="" type="checkbox"/>
7	IBC 16-11 (b)		1.15		<input checked="" type="checkbox"/>	<input checked="" type="checkbox"/>	<input checked="" type="checkbox"/>	<input checked="" type="checkbox"/>	<input checked="" type="checkbox"/>	<input checked="" type="checkbox"/>	<input checked="" type="checkbox"/>
8	IBC 16-11 (c)		1.15		<input checked="" type="checkbox"/>	<input checked="" type="checkbox"/>	<input checked="" type="checkbox"/>	<input checked="" type="checkbox"/>	<input checked="" type="checkbox"/>	<input checked="" type="checkbox"/>	<input checked="" type="checkbox"/>

The first field, the **Description**, is strictly for the user's reference. Enter any descriptive label you wish and it may be displayed with the results when the combination is solved.

The **ASIF** column is used to set the allowable stress increase factor used for both the AISC: ASD code checking and ACI 530 ASD (masonry allowable stress design). See [Allowable Stress Increase](#) regarding its usage for Hot Rolled Steel.

The **CD** factor is the load duration factor and is only necessary for NDS timber design using ASD (see [Load Duration Factor](#)). **Note:** this is **KD** for Canadian (*CSA 086*) wood design.

The **lambda** factor is the time effect factor and is only necessary for NDS timber design using LRFD (see [Time Effect Factor](#)).

The **Service** check box is used in the following applications:

- **Cracked Concrete Section Properties:** Per the provisions of ACI 318-14 Section 6.6.3.2.2 (ACI 318-11 Section R10.10.4.1) the cracked section properties of beams, columns and walls may be multiplied by a factor of 1.43 for service level loads ($\leq 1.0 \cdot I_g$). All concrete members and walls apply this factor when the Service box is checked. Note that this 1.43 factor does not apply to masonry walls. Masonry wall stiffness is NOT dependent on this check box.
- **Story Drift:** The story drift results are broken up by each lateral direction into Service and Strength load combinations. These tabs can be seen in the Story Drift results spreadsheet.
- **Member Deflections:** The first two tabs of the Member Deflections spreadsheet provide deflection and deflection ratio results for Service and Strength load combinations.

The next check boxes designate which load combinations should be used for the code checking of each material type. The example shown uses one set of Load Combinations for the NDS wood design, and another for the ACI concrete design. Member results (Forces, Stresses, Torsion) will only be reported for a members if it's material type has been checked for that load combination. Member results for general material will be shown for all load combinations. For example when using steel and wood in your model, you may design your steel for one set of load combinations and your wood for another.

Load Combinations with RSA Results

The results from response spectra analyses in the X and Y direction may also be included in the load combinations. Remember, when you perform a response spectra analysis (RSA), you specify in which global

direction the spectrum is applied. RISA-2D will retain the three RSA solutions (one for each direction) simultaneously.

Load Combinations															
Combinations		Design													
	Description	Solve	PDelta	SRSS	BLC	Factor	BLC	Factor	BLC	Factor	BLC	Factor	BLC	Factor	
1	Dynamic Mass	<input checked="" type="checkbox"/>			DL	1	LL	.2							
2		<input checked="" type="checkbox"/>													
3	DL+LL+ $SX+0.3SZ$	<input checked="" type="checkbox"/>			DL	1	LL	1	SX	.15	SZ	.05			
4	DL+LL+ $8X-0.3SZ$	<input checked="" type="checkbox"/>			DL	1	LL	1	SX	.15	SZ	-.05			
5	DL+LL+ $0.3SX+SZ$	<input checked="" type="checkbox"/>			DL	1	LL	1	SX	.05	SZ	.15			
6	DL+LL+ $0.3SX+SZ$	<input checked="" type="checkbox"/>			DL	1	LL	1	SX	-.05	SZ	.15			

To include the RSA results for a particular direction in a load combination, enter "Sn" in the BLC field, where n is the global direction. Suppose you wanted to include X direction RSA results, you would enter SX in the BLC field. You would enter SY for Y direction RSA results. Also be sure to put the RSA Scaling Factor for the RSA results in the Factor field. You can have more than one RSA entry in a load combination.

Note

- Remember that RSA results are typically unsigned (all positive) and you should provide some means of accounting for this. The figure above uses two combinations for each RSA result, one with a positive factor and the other with a negative factor to capture the maximum deflections, stresses and forces. See [Unsigned \(All Positive\) Results](#) for more information.
- If you have to combine 2 or 3 different spectra results with many static load combinations, it is convenient to put all the spectra results (SX, SY, and SZ) and factors in one load combination and nest that combination in other combinations. You must set the RSA SRSS flag on each load combination for it to be performed.

SRSS Combination of RSA Results

This is used to cause orthogonal RSA results in the combination to be summed together using an SRSS (Square Root of Sum of Squares) summation. This gives a good approximation of MAXIMUM responses but it also causes all the RSA results to be positive.

You may choose from the options by clicking on the button. The entry is "+" or "-" to indicate whether the combined RSA results are to be added (+) or subtracted (-) from the other loads in the combination.

Note

- This flag is used to combine different spectra that are acting in different directions. This is different than the modal combination method that combines results for one direction and is specified in the **Response Spectra** settings.
- This method was only approved for use in the 1997 UBC and is no longer noted as an appropriate method in the current codes.

Load Combinations with Moving Loads

Moving loads are included in your analysis by referencing them on the Load Combinations spreadsheet. For example, to reference moving load number "n" you would enter "Mn" in one of the BLC fields, and then also enter the corresponding BLC factor. The moving load numbers are shown for each moving load on the **Moving Loads** spreadsheet.

	Description	Solve	PDelta	SRSS	BLC	Factor	BLC	Factor	BLC	Factor	BLC	Factor	BLC	Factor
1	DL	<input checked="" type="checkbox"/>			DL	1								
2	DL+LL	<input checked="" type="checkbox"/>			DL	1	LL							
3		<input checked="" type="checkbox"/>												
4	DL+LL+M1	<input checked="" type="checkbox"/>			DL	1	LL	1	M1	1				
5	DL+LL+M2	<input checked="" type="checkbox"/>			DL	1	LL	1	M2	1				
6	DL+LL+M3	<input checked="" type="checkbox"/>			DL	1	LL	1	M3	1				

Nesting Load Combinations

You are allowed only 10 BLC's per load combination, which may not be enough. For this reason you can define "combinations of load combinations". This means if you need more than 8 BLC entries in a single combination, you can define the needed BLC's and self-weights over several load combinations and then pull these combinations together into another load combination.

	Description	Solve	PDelta	SRSS	BLC	Factor	BLC	Factor	BLC	Factor	BLC	Factor	BLC	Factor
1	Spectra Results	<input checked="" type="checkbox"/>			SX	.13	SZ	.25						
2	DL	<input checked="" type="checkbox"/>			DL	1								
3	DL+LL	<input checked="" type="checkbox"/>			DL	1	LL	1						
4	DL+LL+EL	<input checked="" type="checkbox"/>			DL	1	LL	1	L1	1				

Entering "Lnn" in the BLC field means include all the BLC entries (with their factors) from Load Combination "nn". For example, say Load Combination 4 has "L1" entered for one of its BLC's. This specifies to include all the BLC's (with their factors) entered in Load Combination 1 as part of Load Combination 4 (this includes self-weight and RSA entries as well). The flags for Load Combination 1 (i.e. Solve, PDelta, and SRSS entries) apply only to Load Combination 1 and will not be used when Load Combination 4 is solved.

Also, the factor we enter with the "Lnn" entry will be applied to the BLC factors entered for LC nn. Thus, if we enter "L1" with a factor of "0.9", we're including 90% of the BLC entries of Load Combination 1.

Note

- These "combinations of load combinations" can only be nested to one level; i.e. the load combs referenced with the Lnn entries may not themselves have Lnn entries.

ASIF Factors for Wind / Seismic Load Combinations

Entering a value/factor in the field labeled ASIF (Allowable Stress Increase Factor) indicates that the load combination should be treated as a wind/seismic load combination.

	Description	ASIF	CD	ABIF	Service	Hot Rolled	Cold Form...	Wood	Concrete	Masonry	Footings	Aluminum	Seismic
1	ASCE 1 (a)		.9		<input checked="" type="checkbox"/>	<input checked="" type="checkbox"/>	<input checked="" type="checkbox"/>	<input checked="" type="checkbox"/>	<input type="checkbox"/>	<input checked="" type="checkbox"/>	<input type="checkbox"/>	<input checked="" type="checkbox"/>	<input type="checkbox"/>
2	ASCE 2 (a)				<input checked="" type="checkbox"/>	<input checked="" type="checkbox"/>	<input checked="" type="checkbox"/>	<input checked="" type="checkbox"/>	<input type="checkbox"/>	<input checked="" type="checkbox"/>	<input type="checkbox"/>	<input checked="" type="checkbox"/>	<input type="checkbox"/>
3	ASCE 3 (a) (a)		1.25		<input checked="" type="checkbox"/>	<input checked="" type="checkbox"/>	<input checked="" type="checkbox"/>	<input checked="" type="checkbox"/>	<input type="checkbox"/>	<input checked="" type="checkbox"/>	<input type="checkbox"/>	<input checked="" type="checkbox"/>	<input type="checkbox"/>
4	ASCE 3 (c) (a)		1.15		<input checked="" type="checkbox"/>	<input checked="" type="checkbox"/>	<input checked="" type="checkbox"/>	<input checked="" type="checkbox"/>	<input type="checkbox"/>	<input checked="" type="checkbox"/>	<input type="checkbox"/>	<input checked="" type="checkbox"/>	<input type="checkbox"/>
5	ASCE 4 (a) (a)		1.25		<input checked="" type="checkbox"/>	<input checked="" type="checkbox"/>	<input checked="" type="checkbox"/>	<input checked="" type="checkbox"/>	<input type="checkbox"/>	<input checked="" type="checkbox"/>	<input type="checkbox"/>	<input checked="" type="checkbox"/>	<input type="checkbox"/>
6	ASCE 4 (c) (a)		1.15		<input checked="" type="checkbox"/>	<input checked="" type="checkbox"/>	<input checked="" type="checkbox"/>	<input checked="" type="checkbox"/>	<input type="checkbox"/>	<input checked="" type="checkbox"/>	<input type="checkbox"/>	<input checked="" type="checkbox"/>	<input type="checkbox"/>
7	ASCE 5 (a)		1.6		<input checked="" type="checkbox"/>	<input checked="" type="checkbox"/>	<input checked="" type="checkbox"/>	<input checked="" type="checkbox"/>	<input type="checkbox"/>	<input checked="" type="checkbox"/>	<input type="checkbox"/>	<input checked="" type="checkbox"/>	<input type="checkbox"/>
8	ASCE 6 (a)		1.6		<input checked="" type="checkbox"/>	<input checked="" type="checkbox"/>	<input checked="" type="checkbox"/>	<input checked="" type="checkbox"/>	<input type="checkbox"/>	<input checked="" type="checkbox"/>	<input type="checkbox"/>	<input checked="" type="checkbox"/>	<input type="checkbox"/>
9	ASCE 6 (c)		1.6		<input checked="" type="checkbox"/>	<input checked="" type="checkbox"/>	<input checked="" type="checkbox"/>	<input checked="" type="checkbox"/>	<input type="checkbox"/>	<input checked="" type="checkbox"/>	<input type="checkbox"/>	<input checked="" type="checkbox"/>	<input type="checkbox"/>
10	ASCE 6 (e)		1.6		<input checked="" type="checkbox"/>	<input checked="" type="checkbox"/>	<input checked="" type="checkbox"/>	<input checked="" type="checkbox"/>	<input type="checkbox"/>	<input checked="" type="checkbox"/>	<input type="checkbox"/>	<input checked="" type="checkbox"/>	<input type="checkbox"/>
11	ASCE 7		1.6		<input checked="" type="checkbox"/>	<input checked="" type="checkbox"/>	<input checked="" type="checkbox"/>	<input checked="" type="checkbox"/>	<input type="checkbox"/>	<input checked="" type="checkbox"/>	<input type="checkbox"/>	<input checked="" type="checkbox"/>	<input type="checkbox"/>
12	ASCE 5 (b)		1.6		<input checked="" type="checkbox"/>	<input checked="" type="checkbox"/>	<input checked="" type="checkbox"/>	<input checked="" type="checkbox"/>	<input type="checkbox"/>	<input checked="" type="checkbox"/>	<input type="checkbox"/>	<input checked="" type="checkbox"/>	<input type="checkbox"/>
13	ASCE 6 (b)		1.6		<input checked="" type="checkbox"/>	<input checked="" type="checkbox"/>	<input checked="" type="checkbox"/>	<input checked="" type="checkbox"/>	<input type="checkbox"/>	<input checked="" type="checkbox"/>	<input type="checkbox"/>	<input checked="" type="checkbox"/>	<input type="checkbox"/>
14	ASCE 6 (d)		1.6		<input checked="" type="checkbox"/>	<input checked="" type="checkbox"/>	<input checked="" type="checkbox"/>	<input checked="" type="checkbox"/>	<input type="checkbox"/>	<input checked="" type="checkbox"/>	<input type="checkbox"/>	<input checked="" type="checkbox"/>	<input type="checkbox"/>
15	ASCE 6 (f)	1.33	1.6	1.33	<input checked="" type="checkbox"/>	<input checked="" type="checkbox"/>	<input checked="" type="checkbox"/>	<input checked="" type="checkbox"/>	<input type="checkbox"/>	<input checked="" type="checkbox"/>	<input type="checkbox"/>	<input checked="" type="checkbox"/>	<input type="checkbox"/>
16	ASCE 8	1.33	1.6	1.33	<input checked="" type="checkbox"/>	<input checked="" type="checkbox"/>	<input checked="" type="checkbox"/>	<input checked="" type="checkbox"/>	<input type="checkbox"/>	<input checked="" type="checkbox"/>	<input type="checkbox"/>	<input checked="" type="checkbox"/>	<input type="checkbox"/>

If AISC 9th Edition ASD code checking is selected, the allowable stress increase factor entered in this field is applied to this load combination.

P-Delta Load Combinations

The **P Delta** field is used to perform a P-Delta calculation for that load combination. You may choose from the options by clicking on the  button. A blank field indicates no P-Delta analysis, **Y** indicates that a P-Delta analysis is to be performed for the combination.

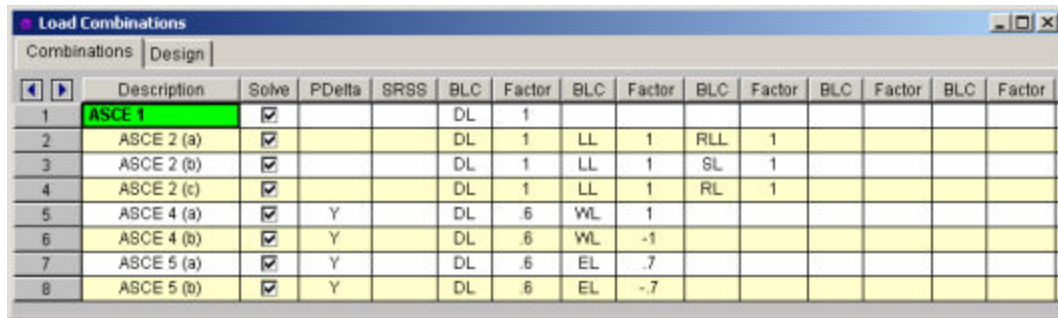

	Description	Solve	PDelta	SRSS	BLC	Factor	BLC	Factor	BLC	Factor	BLC	Factor	BLC	Factor
1	ASCE 1	<input checked="" type="checkbox"/>			DL	1								
2	ASCE 2 (a)	<input checked="" type="checkbox"/>			DL	1	LL	1	RLL	1				
3	ASCE 2 (b)	<input checked="" type="checkbox"/>			DL	1	LL	1	SL	1				
4	ASCE 2 (c)	<input checked="" type="checkbox"/>			DL	1	LL	1	RL	1				
5	ASCE 4 (a)	<input checked="" type="checkbox"/>	Y		DL	.6	WL	1						
6	ASCE 4 (b)	<input checked="" type="checkbox"/>	Y		DL	.6	WL	-1						
7	ASCE 5 (a)	<input checked="" type="checkbox"/>	Y		DL	.6	EL	.7						
8	ASCE 5 (b)	<input checked="" type="checkbox"/>	Y		DL	.6	EL	-.7						

You may also perform a compression only P-Delta analysis. Invoke this option by putting a **C** in the **P Delta** field. See [P-Delta Analysis](#) for more information.

Note

- P-Delta analysis is normally required for LRFD based code checks. If this is not desired, the user may change the setting by selecting Application Settings on the Tools menu and clicking the Solution and Results tab.
- P-Delta analysis is not performed on plates.

Timber Design Load Duration Factor

For Wood design, the load duration factor (CD) is entered in the **CD** field on the row that the particular CD factor applies to. Different load combinations would have different CD factors. For example, per the NDS code, a load combination that had only dead load, would have a CD factor of "0.9", while another combination that was comprised of dead load plus wind load would have a CD factor of "1.6".

The CD factor will only be applied to wood code checks on wood members. "Wood" members are those members whose material properties are defined on the **Wood** tab of the **Material Properties Spreadsheet**.

Note

- See Table 2.3.2 in the NDS 2018 code for the CD factors to be applied for typical loads. Note that the CD factor used for a load combination should be for the load with the *shortest* load duration in that load combination.
- When the Canadian CSA O86 Wood design code is selected, these entries will all change to "KD". See Table 5.3.2.2 of the CSA O86-14 code for direction on what factors to enter.

Generating Building Code Combinations

Major portions of the load combinations that are specified by building codes are included and may be applied to the model for solution. These combinations may be inserted by selecting the  button from the **Window Toolbar** once the **Load Combinations Spreadsheet** is open and active. This will activate the **Load Combination Generator Dialog** shown below:

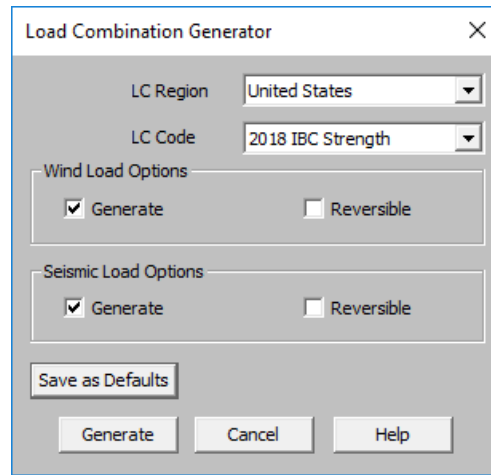

The **LC Region** refers to the various regions supported by the program (U.S., Canada, India, British, et cetera).

The **LC Code** refers to the actual code used to build the load combinations. For the United States, there are a number of different codes that could be used to build load combinations. If the only option is *Sample*, that means that no load combinations have been input for that region. See [Customizing the Load Combination Generator](#) for more information on how to add or edit combinations for that region.

The **Wind Load Options** specify how detailed the generated wind load combinations should be.

The **Reversible** option generates two combinations for each wind load, one with positive load factors and one with negative load factors.

The **Seismic Load Options** specify how complex the generated seismic load combinations should be.

The **X and Z RSA** option will use the spectral seismic loads (SX, SY, SZ) instead of the regular earthquake loading (ELX, ELY, ELZ).

When the **Reversible** box is checked, the program will generate every seismic load combination twice. Once with a positive load factor, once with a negative load factor.

The **Save as Defaults** button may be used to establish the current load combination generator settings as the defaults for future use. Clicking the **Generate** button will generate load combinations in the **Load Combinations Spreadsheet** based on the selected options.

General Notes on the Load Combination Generator

The following loads are not generally included in the standard combinations but may be added by editing the combinations in the spreadsheet or by modifying the source document itself. For more information, see [Customizing the Load Combination Generator](#) below:

Category Code	Description
SX, SY, SZ	Response Spectra Results
TL	Long Term Load
HL	Hydrostatic Load
FL	Fluid Pressure Load
PL	Ponding Load Category
EPL	Earth Pressure Load
OL#	Other Load Categories

Note

- The standard combinations are made up of Load Categories and Factors. Loads that are not assigned to these categories will not be included in the combinations upon solution.
- Some load categories do not occur in all of the design codes. Loads placed in categories that are not part of the standard combinations will not be included in the solution of these combinations.
- All combinations added from the drop down list are added to the envelope solution. You may remove combinations from the envelope after adding them.
- Verify the Wind/Seismic ASIF settings for combinations after you add them.
- After you add the combinations, verify the settings for the wood design Load Duration factor, CD/KD.
- You may specify P-Delta options and SRSS combinations for each combination after you have added them.
- See Editing Spreadsheets - [Inserting, Deleting and Clearing Cells](#) for quick ways to edit or add combinations.
- When a new installation is performed the program will back-up any existing XML files that contain load combination data rather than overwriting them. The back up copies will be given the extension BAK.

Customizing the Load Combination Generator

The Load Combinations for each region are contained in an XML file which can be opened and edited using a standard spreadsheet program. An example of one of these XML files is shown below:

1	A	B	C	D	E	F	G	H	I	J	K	L	M	N	O	P	Q	R	S	T	U	V
1	Label	Solve	pDelta	SRSS	ASIF	CD	ABIF	Service	Hot Rolled	Cold Formed	Wood	Concrete	Masonry	Footings	Aluminum	Stainless	BLC	Factor	BLC	Factor	BLC	Factor
2	IBC 16-1	1	Y						1	1		1	1	1	1	1	DL	1.4				
3	IBC 16-2 (a)	1	Y						1	1		1	1	1	1	1	DL	1.2	LL	1.6	LLS	1.6
4	IBC 16-2 (b)	1	Y						1	1		1	1	1	1	1	DL	1.2	LL	1.6	LLS	1.6
5	IBC 16-2 (c)	1	Y						1	1		1	1	1	1	1	DL	1.2	LL	1.6	LLS	1.6
6	IBC 16-3 (a)	1	Y						1	1		1	1	1	1	1	DL	1.2	RLL	1.6	LL	0.5
7	IBC 16-3 (b)	1	Y						1	1		1	1	1	1	1	DL	1.2	RLL	1.6	WL	0.5
8	IBC 16-3 (c)	1	Y						1	1		1	1	1	1	1	DL	1.2	SL	1.6	SLN	1.6
9	IBC 16-3 (d)	1	Y						1	1		1	1	1	1	1	DL	1.2	SL	1.6	SLN	1.6
10	IBC 16-3 (e)	1	Y						1	1		1	1	1	1	1	DL	1.2	RL	1.6	LL	0.5

The name of the file itself becomes the name of the Load Combination Region that appears in the Load Combination Generator. Each XML file has a series of "worksheets" and the name of each worksheet will be the name of the Load Combination Code that appears in the Load Combination Generator. The user may add, edit or modify these documents to completely customize the available load combinations.

Note

- When the program is updated for new versions, the existing XML files will be "backed up" and saved with a '.bak' extension while the new XML files in the update will replace them. If any customizations were made to the XML files, they can be retrieved from the back ups.

The first row of each sheet is reserved for the column headers. The recognized column headers are as follows: Label, Solve, pDelta, SRSS, ASIF, CD, ABIF, Service, Hot Rolled, Cold Formed, Wood, Concrete, Masonry, Footings, Aluminum, and Stainless,. In addition, there will be multiple pairs of BLC & Factor headers.

Other than Label and the BLC / Factor pairs, the user may omit columns. If a column is omitted, the default values will be used for those entries. The order of the column labels is optional except for pairs of BLC and Factor. For the program to correspond the Factor with correct BLC, the user should always provide BLC label PRIOR to the corresponding Factor. The user may insert blank columns or columns with other labels than described above. In those cases, the program omits those undefined columns.

Note

- As shown in the above example, the wind and seismic loads should be entered as WL and EL in order for them to be "expanded" using the Wind Load Options and Seismic Load Options.

- The program will read these files from the directory specified in Tool - Application Settings - File Locations. See [Customizing RISA](#) for more information.
- SX, SY, and SZ are not valid BLC that can be used within the Load Combination Generator spreadsheet. A response spectra analysis must be done first within RISA-3D.

Loads - Joint Load / Displacement



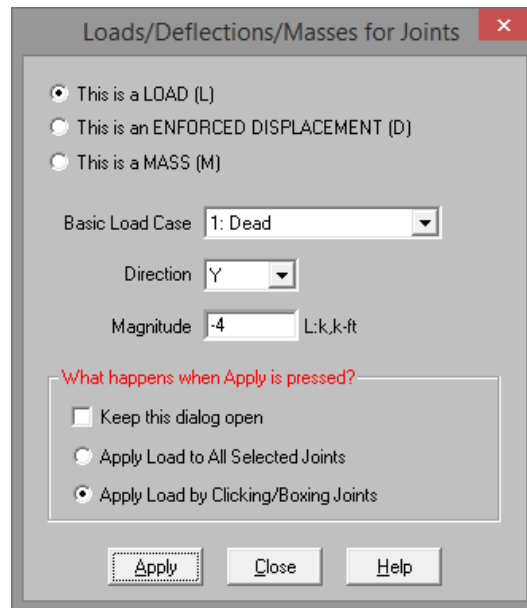

You may specify joint loads, and enforced joint displacements and joint mass in any of the global degrees of freedom. Loads and displacements may be applied in any non-global direction by defining components of the load in the global directions. This may be accomplished graphically or in the spreadsheets. See Drawing Joint Loads below to learn how to apply joint loads/displacements/masses graphically.

Drawing Joint Loads

You can apply joint loads to joints. You must enter the load direction, magnitude and type. Make sure that you are careful to enter the correct BLC number that you want the loads assigned to. See Joint Load/Displacement above for more information on joint loads.



To Apply Joint Loads, Mass and Enforced Displacements

1. If there is not a model view already open then click  on the **RISA Toolbar** to open a new view and click  to turn on the **Drawing Toolbar** if it is not already displayed.
2. Click the **Apply Joint Loads**  button and define the load. For help on an item, click  and then click the item.
3. You may apply the load by choosing joints on the fly or apply it to a selection of joints.

To choose joints on the fly choose **Apply by Clicking/Boxing Joints** and click/box on the joints with the left mouse button.

To apply the load to a selection, choose **Apply Entries to All Selected Items**.

Note

- To apply more loads with different parameters, press CTRL-D to recall the **Joint Loads** settings.
- You may also specify or edit joint loads/displacements in the **Joint Loads Spreadsheet**.
- You may undo any mistakes by clicking the Undo  button.

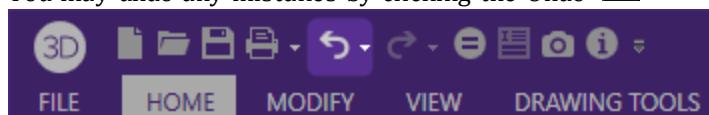

button.

Joint Load Spreadsheet

The **Joint Load Spreadsheet** records the loads for the joints and may be accessed by selecting **Loads** ▶ **Joint Loads** on the **Spreadsheets** menu.

	Joint Label	L,D,M	Directi...	Magnitude[(k,k-ft), (in,rad),...]
1	N1	L	Y	3
2	N2	L	X	5
3	N3	L	MX	50
4	N22	D	X	.5
5	N35	L	MZ	120
6	N1	L	X	12
7	N1	L	Z	5

When you open this spreadsheet you may view only one basic load case at a time. Use the drop down list on the toolbar to specify a different load case. The current load case is also displayed in the title bar at the top of the spreadsheet.

The Joint Label specifies the joint that receives the load or displacement. The same joint may be listed any number of times.

The next column indicates the value is a load or an enforced displacement. Enter "L" if it's a load, "D" if it's a displacement and "M" if it is a mass.

The direction code indicates in which of the global directions the value is applied. Valid entries are X or Y for the translational directions, or MZ for the rotational direction.

The Magnitude column holds the value of the load, displacement or mass. The appropriate units for the magnitudes are displayed at the top of the column. Which units apply depends upon whether the value is a load, displacement or mass, and whether the direction is translational or rotational.

Note

- If you have a "Reaction" or a "Spring" boundary condition for the same degree of freedom that you have an enforced displacement assigned, NO reaction will be calculated. See [Reactions at Joints with Enforced Displacements](#) to learn how work around this limitation.

Joint Mass

For more sophisticated dynamics modeling, you can enter your mass directly as a mass rather than have the program convert it from a load. Using joint masses offers several advantages such as being able to define directional mass and also the ability to specify mass moment of inertia's to account for rotational inertial effects.

The units used for Joint Mass are derived from the current **Force** and **Length** units as specified on the **Units** settings. For example, if the current force units are Kips and the current length units are Feet, you will need to specify your mass as kips / g and mass moments of inertia as kip-ft² / g where g is the acceleration of gravity given in those units (feet per seconds squared).

When specifying a joint mass on the **Joint Loads** spreadsheet, enter an "M" for the load type. The directions are defined relative to the global axes. Enter translational mass using the global **X**, **Y**, or **Z** codes and mass moments of inertia by specifying the global **MX**, **MY** or **MZ**.

Joint masses only allow dynamic response in the direction that they've been applied. This can be a very effective way to prevent local modes. A good example is a floor diaphragm modeled with plate/shell finite

elements. If the mass is only specified for the two lateral directions, you will prevent any unwanted vertical modes. Care must be taken in limiting dynamic response using directional mass for complicated structures. A structure that has “coupled modes” will not give the “real” dynamic response when mass is only specified in one or two directions. A coupled mode is a mode that has mass participate in two or three directions at one time.

Joint masses also allow you to account for rotational inertia effects by specifying a mass moment of inertia. These are particularly important when you’re using a rigid diaphragm and you’ve also lumped all your mass at one point (typically the center of mass). The rotational inertia effects contribute to the torsion on the diaphragm and should not be neglected. The following table shows some typical diaphragm shapes and the formulas to calculate their mass moment of inertias. Note that you can use the axis transformation equation to calculate the mass moment of inertia for diaphragms that are combinations of these basic shapes. For very irregular diaphragms, a more general equation is given based on the in-plane moment of inertia and the area of the diaphragm.

Mass Moment of Inertia About an Axis Through the Center of Mass

In the table below C.M. is the center of mass point. M is the total Mass of the area (typically including self weight, dead load, and a percentage of the live load) and is assumed to be uniformly distributed throughout. I_{xx} is the moment of inertia about the X-X axis. I_{zz} is the moment of inertia about the Z-Z axis. A is the area. MMI_o is the mass moment of inertia about some other point.

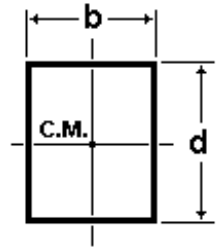
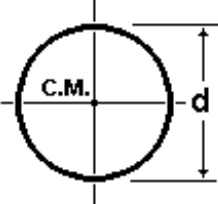
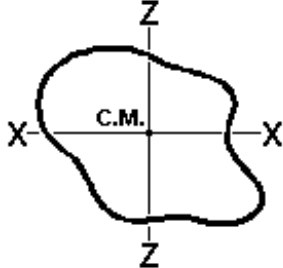
Area Plan View	Formula
	$M (b^2 + d^2) / 12$
	$M d^2 / 8$
	$M (I_{xx} + I_{zz}) / A$

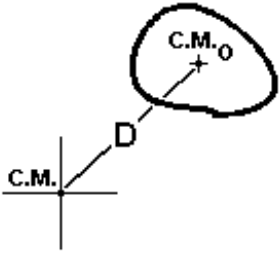
Area Plan View	Formula
	$MMI_o + M D^2$

Loads - Point Loads

Point loads are concentrated loads applied along the span of a member or the edge of a wall panel. Defining point loads may be accomplished graphically or in the spreadsheets. See [Drawing Point Loads](#) below to learn how to draw joint loads graphically.

Drawing Point Loads



To apply point loads, enter the load direction, magnitude, and location. Make sure that you are careful to enter the correct BLC number that you want the loads assigned to.

Note:

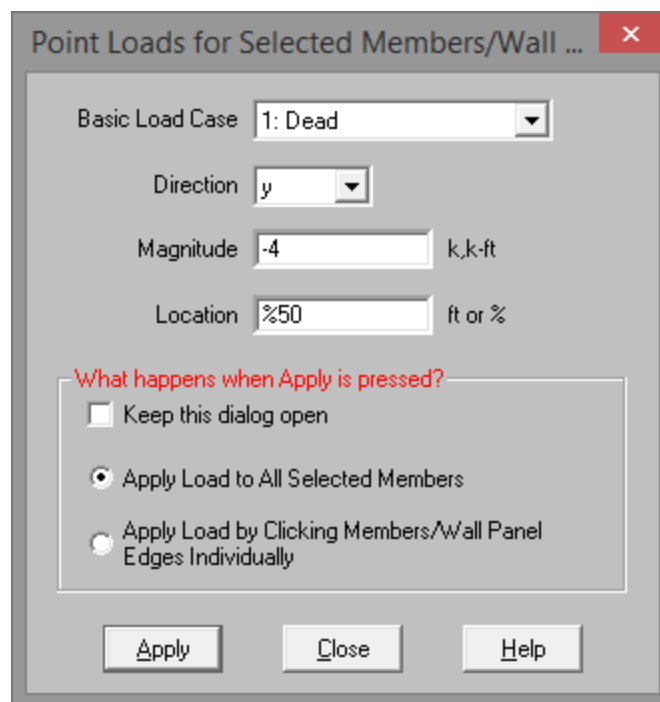
- In the event that a member end offset exists and the load lies on the offset the load will be applied at the end of the offset.



To Apply Point Loads

1. If there is not a model view already open then click  on the **RISA Toolbar** to open a new view and click  to turn on the **Drawing Toolbar** if it is not already displayed.
2. Click the **Apply Point Loads**  button and define the load.
3. You may choose to apply the load to a single member/wall panel at a time or to an entire selection of members/wall panels.

To apply the load to just a few elements choose **Apply Entry by Clicking Items Individually** and click **Apply**. Click on the members or wall panels with the left mouse button.

To apply the load to a selection, choose **Apply Entries to All Selected Items** and click **Apply**.

Note:

- To apply more loads with different parameters, press CTRL-D to recall the **Point Loads** settings.
- You may also specify or edit point loads in the **Point Load Spreadsheet**.
- You may undo any mistakes by clicking the **Undo**  button.

Point Loads from a Moving Load

Please see the [Moving Loads](#) topic for more information on how to create static point loads from a specific moving load step location.

Point Load Spreadsheet

The **Point Load Spreadsheet** records the point loads for the member elements and may be directly accessed by selecting **Loads** ▶ **Point Loads** on the **Spreadsheets** menu

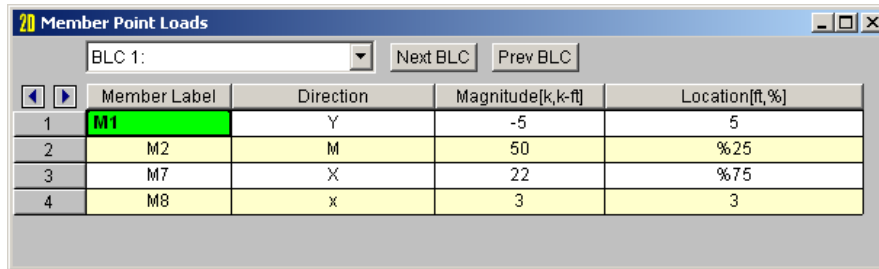

	Member Label	Direction	Magnitude[k,k-ft]	Location[ft,%]
1	M1	Y	-5	5
2	M2	M	50	%25
3	M7	X	22	%75
4	M8	x	3	3

The first column contains the label of the member or wall panel to receive the load.

The direction in the second column represents the direction of the load as one of the options mentioned above.

The load magnitude is recorded in the third column. The units for the magnitude are listed at the top of the column, depending upon whether the load is a force or a moment.

The fourth column contains the location of the load. The location is the distance from the I-joint of the member and is unaffected by any member offsets. The location of the load may be defined as a percentage of member length. To define the distance from the I-joint as a percentage of member length, enter the percentage value (0 to 100), preceded by the symbol "%". For example, a load in the center of the member would be defined with a location of "%50". Using a percentage value is handy if the member's length will be changing due to editing of the model coordinates and you wish to have the load some proportional distance from the I end.

The **Wall Panel Point Loads Spreadsheet** records the point loads on your wall panels. Note that the loads are specific to the BLC's and that you can use the drop-down list to scroll between your various load cases. The columns in the spreadsheet are the same as the member point loads spreadsheet.

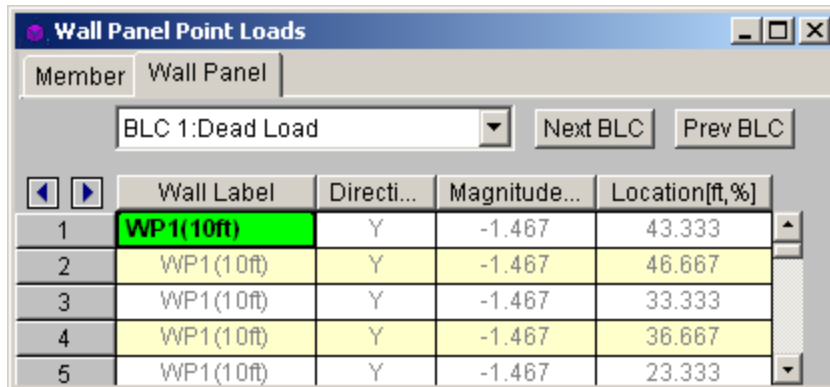

	Wall Label	Directi...	Magnitude...	Location[ft,%]
1	WP1(10ft)	Y	-1.467	43.333
2	WP1(10ft)	Y	-1.467	46.667
3	WP1(10ft)	Y	-1.467	33.333
4	WP1(10ft)	Y	-1.467	36.667
5	WP1(10ft)	Y	-1.467	23.333

Point Load Directions

x, y - Load applied in local x and y direction

X, Y - Load applied in global X, and Y direction

M - Moment about global axis

Loads - Distributed Loads

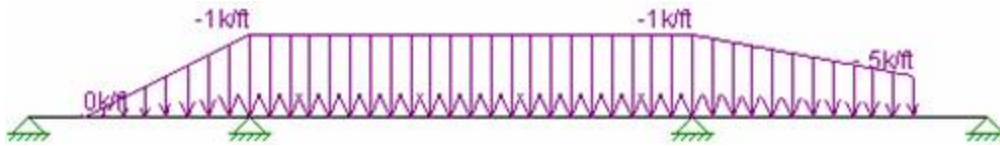

Distributed loads are loads that are spread across all or part of a member or wall panel and can be of uniform, stepped, or varying magnitude such as triangular or trapezoidal. You may define distributed loads graphically or by using the spreadsheets. See Drawing Distributed Loads below to learn how to draw distributed loads graphically.

Note

- If a member has offsets defined, the offset distances will NOT be loaded. The locations are still relative to the I joint, but if the start location is less than the I End Offset, the part of the load applied along the offset distance will be ignored. The same is true for the end location and the J End Offset. So a full-length load is actually applied to a length equal to the full I to J joint distance minus the I-End and J-End offset distances.



Drawing Distributed Loads

You can apply distributed loads to members or wall panels. The direction of the load may either be defined in the global axes or the local axes of the member and may also be projected. For full length loads leave the Start and End Locations as zero.

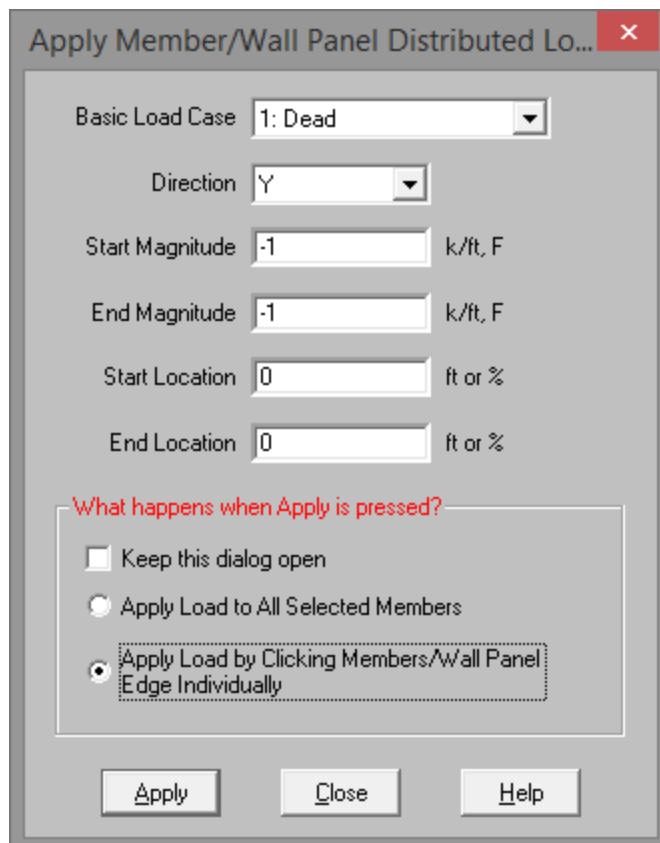
Make sure that you are careful to enter the correct Basic Load Case number that you want the loads assigned to.



To Apply Distributed Loads

1. If there is not a model view already open, then click  on the **RISA Toolbar** to open a new view and click  to turn on the **Drawing Toolbar** if it is not already displayed.
2. Click the **Apply Distributed Load**  button and define the load.
 - For full member length loads leave the Start and End Locations as zero.
3. You may choose to apply the load to a single element at a time or to an entire selection of members and/or wall panels.
 - To apply the load to only a few members/wall panels, choose **Apply Entry by Clicking Items Individually** and click **Apply**. Click on the members/wall panels with the left mouse button to apply the load.
 - To apply the load to a selection of members/wall panels, choose **Apply Entries to All Selected Items** and click **Apply**. The load will then be applied to all the selected elements in the model.

Note

- To apply more loads with different parameters, press **CTRL + D** to recall the **Distributed Loads** settings.
- You may also specify or edit distributed loads in the **Distributed Load Spreadsheet**.

Distributed Loads Spreadsheet

The **Member Distributed Load Spreadsheet** records the distributed loads for the member elements and may be accessed by selecting **Loads** ▶ **Distributed Loads** on the **Spreadsheets** menu, or by clicking **Distributed Loads** on the **Data Entry** toolbar.

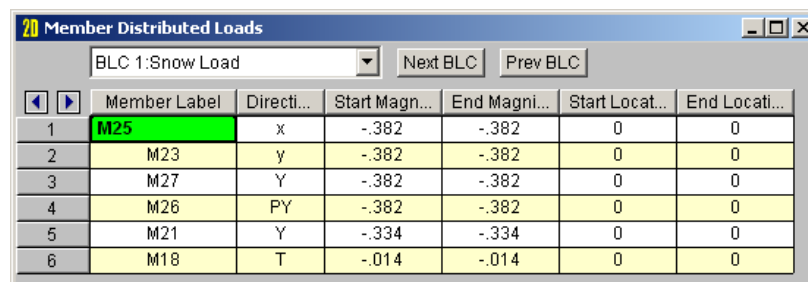

	Member Label	Directi...	Start Magn...	End Magni...	Start Locat...	End Locati...
1	M25	x	-382	-382	0	0
2	M23	y	-382	-382	0	0
3	M27	Y	-382	-382	0	0
4	M26	PY	-382	-382	0	0
5	M21	Y	-334	-334	0	0
6	M18	T	-014	-014	0	0

The first column contains the Label of the element being loaded.

The Direction specified in the second column indicates which axes are to be used to define the load directions and whether or not the load is to be projected. Directions are discussed in the next section.

Start and End Magnitudes of the load must be specified. Start and End locations for the load need only be specified if the load is not across the full member length. If both locations are left as zero then the load will be applied across the full member length.

The Location columns contains the location of the load. The location is the distance from the I-joint of the member and is unaffected by any member offsets. The location of the load may be defined as a percentage of member length. To define the distance from the I-joint as a percentage of member length, enter the percentage value (0 to 100), preceded by the symbol "%". For example, a load starting or ending in the center of the member would be defined with a start or end location of "%50". Using a percentage value is handy if the member's length will be changing due to editing of the model coordinates and you wish to have the load some proportional distance from the I end.

The **Wall Panel Distributed Loads Spreadsheet** records the distributed loads on your wall panels. Note that the loads are specific to the BLCs and that you can use the drop-down list to choose a different one. The columns in the spreadsheet are the same as the member distributed load spreadsheet.

	Wall Label	Directi...	Start Magn...	End Magni...	Start Locat...	End Locati...
1	WP1(10ft)	Y	-0.085	-0.085	0	3.333
2	WP1(10ft)	Y	-0.085	-0.085	3.333	6.667
3	WP1(10ft)	Y	-0.085	-0.085	6.667	10
4	WP1(10ft)	Y	-0.085	-0.085	10	13.333
5	WP1(10ft)	Y	-0.085	-0.085	13.333	16.667
6	WP1(10ft)	Y	-0.085	-0.085	16.667	20

	Wall Label	Direction	Start Magnitude [k/ft, F]	End Magnitude [k/ft, F]	Start Location [(ft, %)]	End Location [(ft, %)]	Inactive
1	REV_W2(24ft)	Y	-0.368	-0.368	15	30	
2	REV_W2(24ft)	Y	-0.368	-0.368	15	30	
3	REV_W2(24ft)	Y	-0.368	-0.368	15	30	
4	REV_W2(24ft)	Y	-0.368	-0.368	15	30	
5	REV_W2(24ft)	Y	-0.368	-0.368	15	30	
6	REV_W2(24ft)	Y	-0.368	-0.368	15	30	
7	REV_W2(24ft)	Y	-0.368	-0.368	30	60	

Distributed Load Directions

The direction code indicates how the distributed load is to be applied. Following are the valid entries:

Entry	Load Direction
x or y	Applied in the member's local x or y-axis
X or Y	Applied in the global X or Y-axis
T (or t)	Thermal (temperature differential) load
PX	Projected load in the global X-axis direction
PY	Projected load in the global Y-axis direction
SX	Pressure load applied to projected surface of member in the global X-axis direction
SY	Pressure load applied to projected surface of member in the global Y-axis direction
Sy	Pressure load applied to projected surface of member in the local y-axis direction

This diagram illustrates the difference between local (x, y, z) and global (X, Y, Z) direction loads:

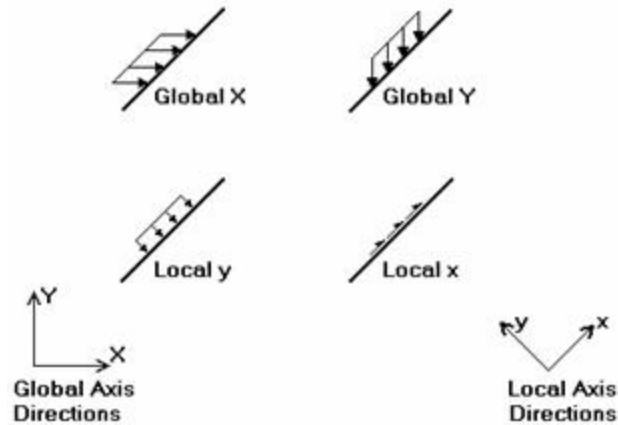

In this diagram, the local y and global Y loads shown are both negative, while the local x and global X loads are positive. As can be seen, local direction loads line up with the element's local axis directions, so their direction relative to the rest of the model changes if the member/wall panel orientation changes. Global loads have the same direction regardless of the element's orientation.

A distributed load in the Mx direction will be applied to the member/wall panel according to the right hand rule. Remember that the positive local x-axis extends from the I joint of a member towards the J joint.

Projected Loads

Keep in mind that global loads are applied without being modified for projection. For example, a full length Y direction load of 1 kip/foot applied to a 10 foot member inclined at 45 degrees generates a total force of 10 kips. Projected loads, on the other hand, are applied in the global directions but their actual magnitude is influenced by the member's orientation. The load is applied to the "projection" of the member perpendicular to the direction of the load. For example, a "PY" direction load is a projected load applied in the global Y direction. The actual magnitude of the load is the entered magnitudes reduced by the ratio L/L_x , where L is the member's full length and L_x is the member's projected length on the global X-axis. See the following figure:

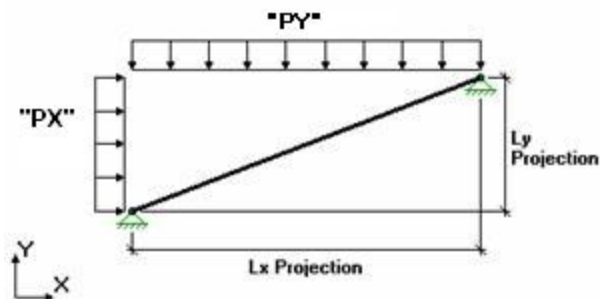

So the total load generated is equal to the input magnitudes applied along the projected length. This generated force is distributed along the full member length, so the applied magnitudes are reduced accordingly.

For additional advice on this topic, please see the RISA Tips & Tricks webpage at risa.com/post/support. Type in Search keywords: **Projected Loads**.

Surface Loads

This is a load type that applies a pressure load to the face of the member in the direction specified. If a local axis direction is specified then the load will be applied to the strong/weak direction of the member regardless of the member orientation. If using the global coordinates then the program will take the projected face of the element in the direction in question and calculate the pressure area accordingly.

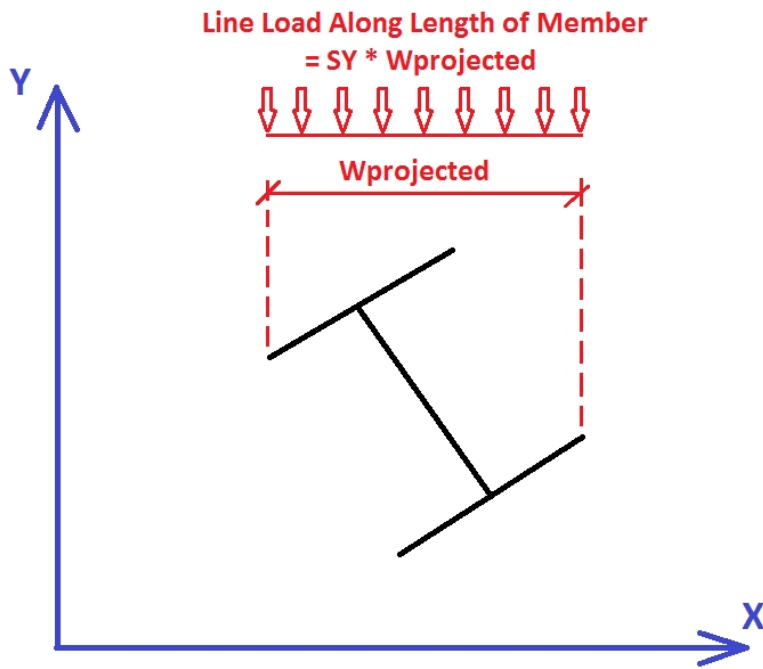

The program then takes this pressure multiplied by the width of the pressure area and creates a line load that is then applied to the member.

Note:

- Distributed pressure loads can not be applied to tapered members or wall panels.

Loads - Moving Loads

The standard AASHTO loads are built into the moving loads database, however you can add and save custom moving loads as well. The moving loads can be applied in any direction, so they can be used to model crane loadings (which are typically applied in 2 or 3 directions at the same location). You can have up to 5,000 moving loads in each model.

To Apply a Moving Load

1. From the **Spreadsheets** menu, select the **Loads - Moving Loads** spreadsheet.
2. Specify a pattern in the **Pattern** field by selecting it from the drop down list.
3. In the **Increment** field specify the distance for the load pattern to be stepped through the path.
4. Specify the path by defining the **Joints** in the remaining fields and indicate if you wish the pattern to be moved **Both Ways** through the path.

	Tag	Pattern	Increment(ft)	Both Ways	1st Joint	2nd Joint	3rd Joint	4th Joint	5th Joint	6th Joint
1	M1	HS20-26	1	<input checked="" type="checkbox"/>	N1	N11	N15	N17		
2	M2	HS20-30	1	<input checked="" type="checkbox"/>	N1	N11	N25	N35		
3	M3	HS20-30	2	<input type="checkbox"/>	N1	N11	N30	N40		

Note

- You may skip joints when specifying the path. The moving load feature is “smart” in the sense that it will try to find a way to get from one joint to the next joint in the load path sequence. The load path taken will usually be the most direct route between the joints and may be verified by animating the moving load.
- For example, in the image below, if you want the moving load to move left to right along the beam member (M4), there is no need to specify the intermediate joint (N4) in the moving load path.

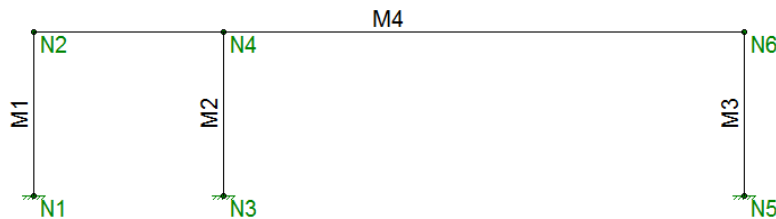

	Tag	Pattern	Increment(ft)	Both Ways	1st Joint	2nd Joint	3rd Joint	4th Joint	5th Joint	6th Joint
1	M1	HS20-26	1	<input type="checkbox"/>	N2	N6				

To Animate a Moving Load

1. If there is not a model view already open, click on the **RISA Toolbar** to open a new view and make any adjustments you wish to appear in the animation.
2. On the **Window Toolbar** click the **Model Display Options** button.
3. Select the moving load or load combination from the drop-down list at the bottom of the options and then click on the **Animate** button.

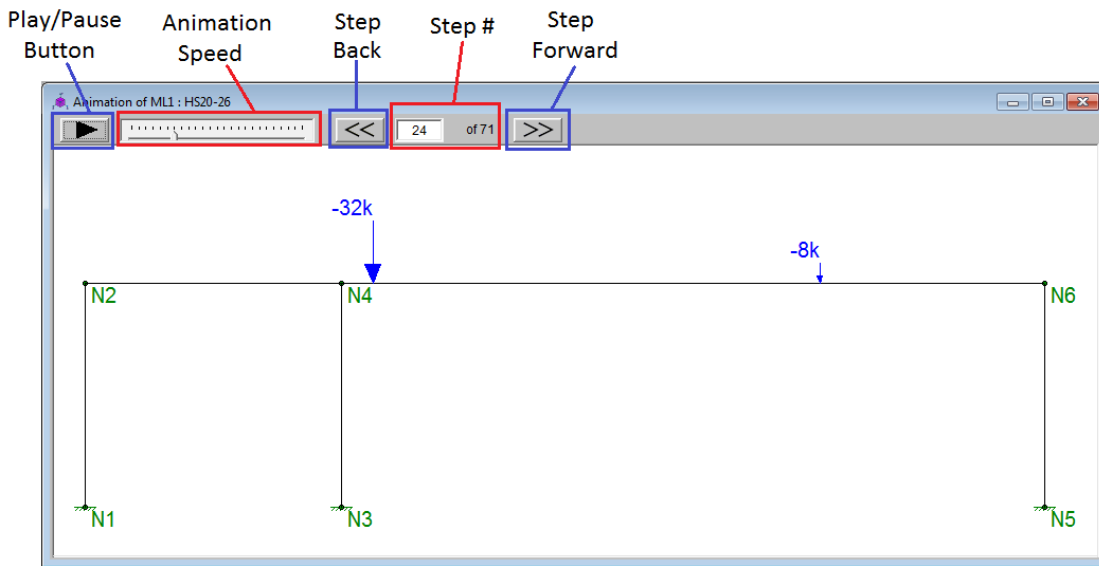

To Include a Moving Load in a Load Combination

1. To include a moving load in your analysis, specify it in the **Load Combinations** spreadsheet in one of the **BLC** fields and enter a corresponding BLC Factor.
2. You may either type in the moving load tag (i.e. **M1**, **M2**, etc.) directly or you may select it by clicking the red arrow to open the **Set BLC Entry** dialog. Choose the appropriate moving load from the drop down list.

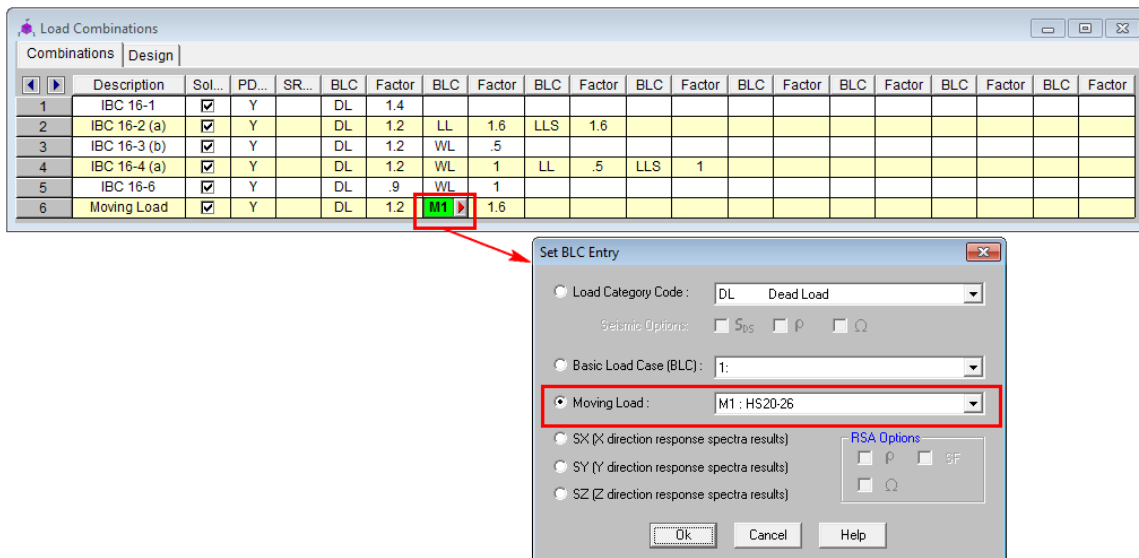



Moving Loads Spreadsheet

The **Moving Loads Spreadsheet** records the moving loads for the member elements and may be accessed by selecting **Loads** > **Moving Loads** on the **Spreadsheets** menu.

	Tag	Pattern	Increment(f)	Both Ways	1st Joint	2nd Joint	3rd Joint	4th Joint	5th Joint	6th Joint
1	M1	HS20-26	1	<input checked="" type="checkbox"/>	N1	N11	N15	N17		
2	M2	HS20-30	1	<input checked="" type="checkbox"/>	N1	N11	N25	N35		
3	M3	HS20-30	2	<input type="checkbox"/>	N1	N11	N30	N40		

Each moving load definition is automatically assigned a **Tag** on the left side of the spreadsheet. These labels may not be edited. Moving loads are included in your analysis by referencing this label on the **Load Combinations** spreadsheet.

The **Pattern** field is the name of the moving load pattern used for that particular moving load definition. You can access the drop-down list of valid pattern names by clicking the down  arrow in this cell. You may access the [Moving Load Patterns](#) and add or edit your own patterns by clicking on the **Moving Load Patterns**  button on the **RISA Toolbar**.

The **Increment** field is the distance that the moving load will be moved for each step in the moving load analysis.

The **Both Ways** field is a check box that indicates whether the moving load pattern is to be applied in both directions of the load path or just one way along the load path. If the box is checked the load is first run from the start joint all the way to the last joint of the load path. The load is then turned around and the last joint is now treated as the first joint in the load path. The load is then run back to the first joint in the load path.

The last 10 fields are the joint numbers that are used to define the load path for the moving load. The moving load feature is smart in the sense that it will try to always find a way to get from one joint to the next joint in the load path sequence. The load path taken will usually be the most direct route between the joints. If you have a long series of co-linear members, or if there is only one valid path between your start and end joints, you usually will only need to specify the first joint and the last joint in the series. If there are several members that branch from a joint that are all part of valid paths to the next joint in the sequence, the member with the lowest member number will be the one chosen. To control exactly which route is taken in this situation, use joints at each intersection point. See the figure below:

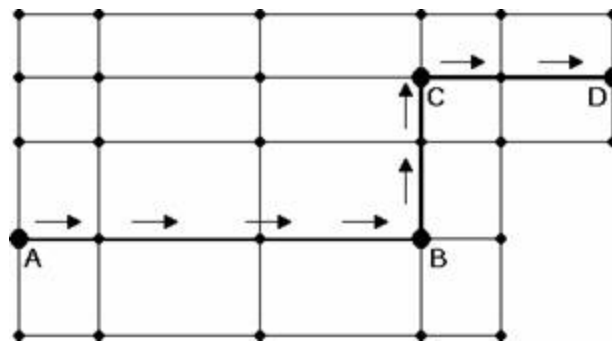

In the example moving load path shown, you would need to specify joints A, B, C, and D as the load path joints. You would not have to specify the joints that were in between the points where the load path changed direction; i.e., the moving load would automatically go in a straight line from joint A to B, etc.

Moving Load Patterns

You may access the Moving Load Patterns and add or edit your own patterns by clicking on the **Moving Load Patterns**  button on the **RISA Toolbar** and then clicking on **Add Pattern** or **Edit Pattern**.

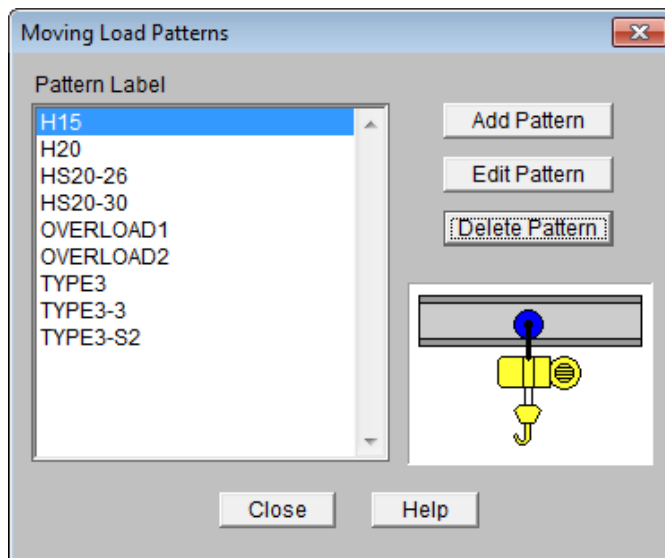

The file that the moving load pattern database is stored in is **ML_LIB32.FIL**. The path to this file is specified in the **Application Settings** on the **Tools** menu. You can add up to 500 different moving load patterns in the pattern database.

When you add a new pattern, the new pattern must have a unique name and can consist of up to 50 different loads. The sign of the load **Magnitude** will control which way the load is pointing in the direction specified in the **Direction** field. The direction field can be any of the 3 global directions or the 3 local directions for the members that the load will travel over. Note that if your load travels over multiple members, a local direction load will be applied based on the local axes of each member it crosses over. There is also a special code, "V", which causes the load to be applied in the direction of the current vertical axis, whatever it is (X, Y, or Z). The **Distance** is the distance between the loads.

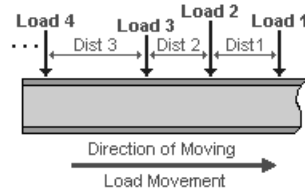

Note: If you have two loads at the same location but in different directions, you may input them one after the other with a Distance between them of 0 ft/m, as shown in the image below:

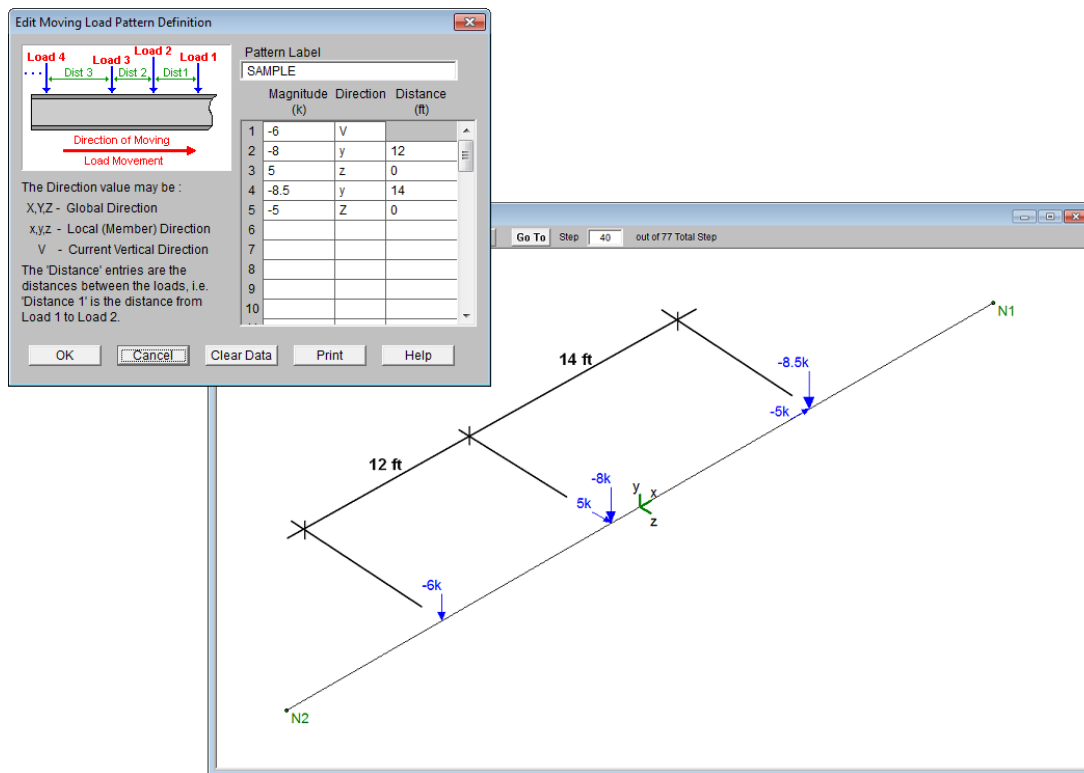

Moving Loads Solution Procedure

Moving loads are handled internally by applying the loads at discrete locations that are then moved through the model. A static solution is performed for the model at each load location. Typically, once the first solution is solved, the remaining loads are just solved against the existing stiffness matrix, so the stiffness matrix would not be rebuilt for each load position.

Note:

- Models that contain tension/compression only items will have their stiffness matrix rebuilt at least once at each load position. This can make the model solution take much longer than usual.
- Multiple moving loads may be assigned to a single load combination. However, they cannot be assigned different "start times". If a delay between moving loads is required, it must be accomplished by adjusting the moving load pattern.
- The load increment may be adjusted to "slow down" a moving load when multiple moving loads are applied.

Moving Loads Results

Load combinations that contain a moving load, will step the moving load through the load path and perform a solution for each position. The results are enveloped, giving maximum and minimum results of these solutions.

For these result spreadsheets, the maximum and minimum values are shown for each section location, for each active member. The governing load combination and step location is also shown for each result value under the "LC" column. The first number is the load combination, the second is the step number: (load combination - step number).

	Joint		X [k]	LC	Y [k]	LC	Z [k]	LC	MX [k-ft]	LC	MY [k-ft]	LC	MZ [k-ft]	LC
1	N1	max	1.398	5-5	10.729	7-74	0	1-1	0	1-1	0	1-1	2.541	5-14
2		min	-9	7-62	-2.443	7-61	0	1-1	0	1-1	0	1-1	-5.538	7-50
3	N3	max	5.035	7-57	14.016	7-64	0	1-1	0	1-1	0	1-1	3.503	5-5
4		min	-1.497	5-6	0	2-1	0	1-1	0	1-1	0	1-1	-13.591	5-23
5	N5	max	.21	5-8	12.789	5-31	0	1-1	0	1-1	0	1-1	9.603	5-23
6		min	-5.596	5-24	-.14	5-7	0	1-1	0	1-1	0	1-1	-.671	5-8
7	N7	max	1.398	6-5	10.729	8-74	0	1-1	0	1-1	0	1-1	2.541	6-14
8		min	-9	8-62	-2.443	8-61	0	1-1	0	1-1	0	1-1	-5.538	8-50
9	N9	max	5.035	8-57	14.016	8-64	0	1-1	0	1-1	0	1-1	3.503	6-5
10		min	-1.497	6-6	0	1-1	0	1-1	0	1-1	0	1-1	-13.591	6-23
11	N11	max	.21	6-8	12.789	6-31	0	1-1	0	1-1	0	1-1	9.603	6-23

Step Location

The step location tells you where the moving load was located along the moving load path when the maximum or minimum result value was obtained. This can help you recreate the static model to verify results.

The total number of steps is calculated as follows:

$$\text{Total Number of Steps} = \frac{\text{Total Path Length} + \text{Distance Between Loads} + \text{Increment}}{\text{Increment}}$$

Note

- The results for every load position are not stored; just the maximums and minimums. Therefore the program is unable at this time to give a detail report solution for the moving load results. However this is an enhancement that we do plan on adding in the future.

Moving Load Step Point Load Generation

Because solving moving loads produces so much output (full model design at each moving load step increment), the output is limited to Enveloped results. This means that the moving load results only show the maximum and minimum values for each output result value.

However there are times when you may want to investigate the full model design (all member results, detail reports, deflected shape, etc.) at a specific step. You can easily create a static load case of the moving loads at a specific load step using the **Point Loads from a Moving Load** feature.

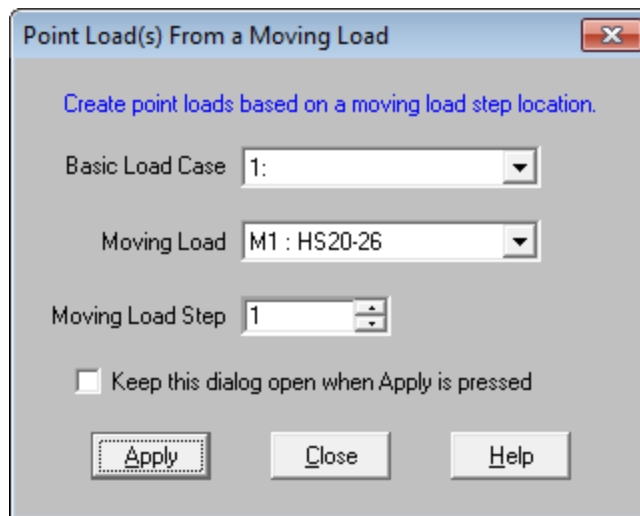

Instructions to use this feature:

1. Determine which moving load step you want to investigate.

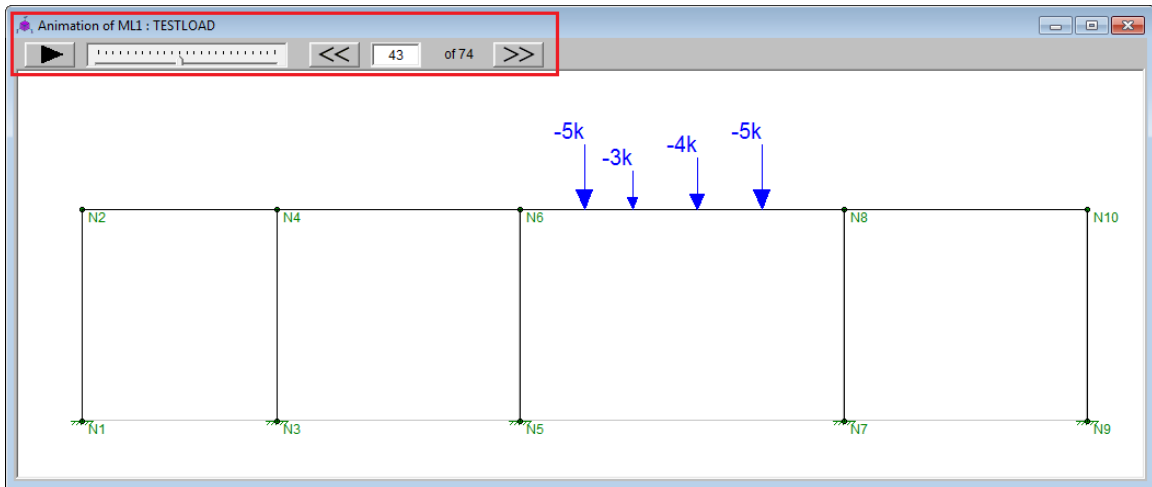

2. Access this feature from the Drawing toolbar button , or from the **Insert - Point Load from a Moving Load** menu.
 - a. Select which **Basic Load Case** you want the static point loads to be added to.
 - b. Select which **Moving Load** or Load Combination with a moving load you want the point loads generated from.
 - c. Select the **Moving Load Step** you want the static point loads generated from.

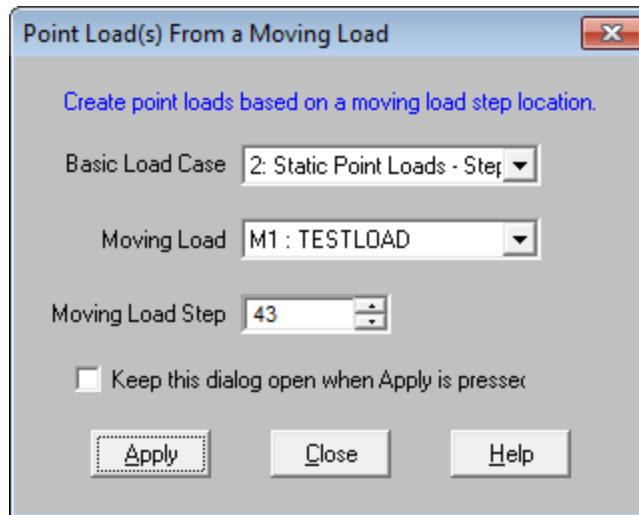

3. Click **Apply**.

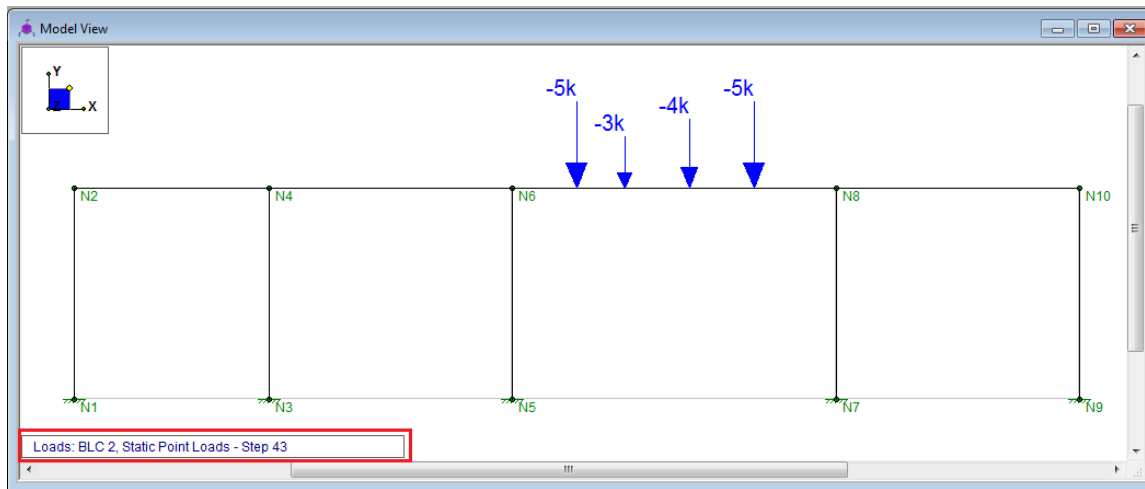

4. Create a Load Combination that includes the Basic Load Case selected in step #2a above and solve to see the full results.



Loads - Thermal Loads

You can model the effects of temperature differentials in members and plates. For members, these loads cause the axial expansion or contraction of the member along its length, i.e. axial stress only. The temperature is assumed constant across the member's depth. For plates, these loads cause an in-plane expansion or contraction of the plate. The temperature is assumed constant through the thickness of the plate.

Note

- The internal axial deflections for beam members are the average of the end deflections for thermal loads.

To Apply a Thermal Load

1. Select the members you wish to assign a thermal load.
2. Click  to turn on the **Drawing Toolbar** if it is not already displayed and click the **Apply Distributed Load**  button.
3. Define a distributed load with a direction of T and a magnitude, in temperature.

Note

- You may also specify or edit thermal loads in the **Distributed Loads Spreadsheet** or the **Plate Surface Loads Spreadsheet**.
- An easy way to do thermal loadings is to define the joint temperatures (on the Joint Coordinates Spreadsheet) as all zero, so any defined thermal loads are the full stress inducing temperatures.

Recording Thermal Loads for Members

The Coefficient of Thermal Expansion (α) is entered on the **Materials** spreadsheet. Note that this value is entered per 100,000 degrees (it is sometimes listed per 1,000 degrees).

The joint temperatures recorded on the **Joint Coordinates** spreadsheet define the ambient thermal state of the structure. Thermal loads, entered as distributed loads on the **Distributed Loads** spreadsheet, induce axial stress in the member.

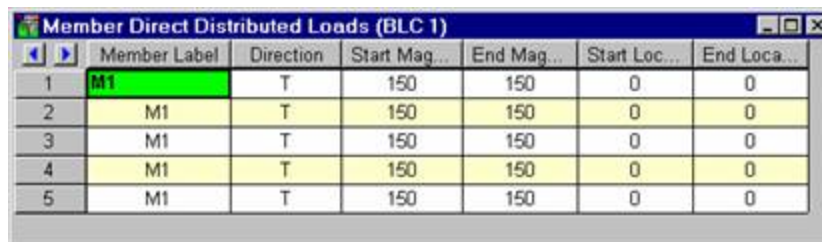

	Member Label	Direction	Start Mag...	End Mag...	Start Loc...	End Loca...
1	M1	T	150	150	0	0
2	M1	T	150	150	0	0
3	M1	T	150	150	0	0
4	M1	T	150	150	0	0
5	M1	T	150	150	0	0

The difference between the applied thermal load and the ambient temperature is the stress inducing temperature.

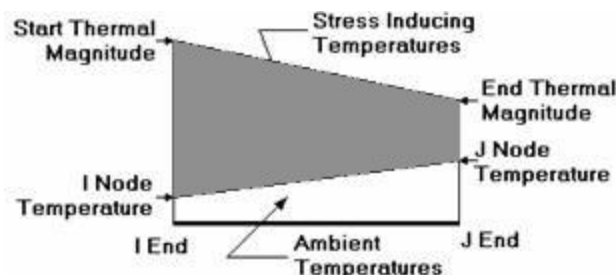

Since you can define start and end locations for the thermal load, you can define up to three separate thermal regions. Interpolating from the I-end temperature to the start thermal load for the first region, from the start thermal load to the end thermal load for the second region and from the end thermal load to the J end temperature for the third region.

Thermal Force Calculation

The joint temperatures recorded on the **Joint Coordinates** Spreadsheet define the ambient thermal state of the structure. The joint temperature at the I-end of the member is interpolated across to the J end temperature to define the ambient state of the member. Thermal loads, entered as distributed loads on the **Distributed Loads** Spreadsheet, induce axial stress in the member. The difference between the applied thermal load and the ambient temperature is the stress inducing temperature.

Thermal forces are calculated thusly:

$$F_t = A * E * \alpha * \Delta T$$

Where,

F_t = Calculated Thermal Force

A = Member Cross Sectional Area

E = Elastic Modulus

α = Coefficient of Thermal Expansion

ΔT = Stress Inducing Temperature

Prestressing with Thermal Loads

Thermal loads provide a way to introduce pre-stressing in a model. Given a desired prestress force, just back-solve the thermal force equation for the needed ΔT . Remember, as the model expands (or contracts), the prestress force may be altered.

Material Properties

Material properties are defined on the **Material Properties Spreadsheet** and then are referred to as you build section sets, members, and plates. You may perform analysis using any type of material; simply define the properties for the material here. You may use up to 500 materials in a single model although most models will only have one or two. For example, your model might be made up of members of various grades of steel along with different concrete materials, timber or aluminum.

Material Properties Spreadsheet

The **Material Properties Spreadsheet** records the material properties to be used in the model and may be accessed by selecting **Materials** on the **Spreadsheets Menu**. The entries are explained below.

	Label	E [ksi]	G [ksi]	Nu	Therm ...	Densit...	Yield[k...
1	A992	29000	11154	0.3	0.65	0.49	50
2	A36 Gr.36	29000	11154	0.3	0.65	0.49	36
3	A572 Gr.50	29000	11154	0.3	0.65	0.49	50
4	A500 Gr.B RND	29000	11154	0.3	0.65	0.527	42
5	A500 Gr.B RECT	29000	11154	0.3	0.65	0.527	46
6	A500 Gr.C RND	29000	11154	0.3	0.65	0.527	46
7	A500 Gr.C RECT	29000	11154	0.3	0.65	0.527	50
8	A53 Gr.B	29000	11154	0.3	0.65	0.49	35
9	A1085	29000	11154	0.3	0.65	0.49	50
10	A913 Gr.65	29000	11154	0.3	0.65	0.49	65

The values for A36 steel are the default material set. You of course don't have to use the A36 properties; you can change these and also add as many other materials as you need. You may then save your preferred materials as the default materials by clicking the **Save as Defaults**  button on the **Window Toolbar**.

Label is the material label you wish to use to describe the entered material properties. This label is how you will reference the set of properties later when defining section sets, members, and plates.

E is Young's modulus that describes the material stiffness.

G is the shear modulus and may be left blank if you would like it calculated automatically. The equation for "G" is:

$$G = \frac{E}{2.0 * (1.0 + Poisson's Ratio)}$$

Note

- If you enter a value for Shear Modulus that does not match the value calculated using the above equation you will be given a warning.
- The default Plywood material has a much lower G value than the formula above would suggest. This is because plywood is NOT an isotropic material. Also, the generic value (from the NDS or APA's Plywood Design Specification) has been reduced somewhat to account for assumed nail slip.

Nu is Poisson's ratio. Besides being used for the "G" calculation, this value is also used for shear deformation calculations. The value of Poisson's ratio may not exceed '0.5'.

Therm is the coefficient of thermal expansion and is entered per 10^5 (100,000) degrees. This coefficient is used in the calculation of thermal loads.

Density is the material density and is used in the calculation of the member and plate self weight. This density times the area gives the self weight per unit length for the members; density times plate volume gives the total weight of a given plate.

Yield is the yield stress and is used only for Hot Rolled and Cold Formed steel design.

Cold Formed Specific Material Data

The **Cold Formed** tab records a cold formed material property that may not exist for the other materials. This entry is described below:

	Hot Rolled	Cold Formed	Wood	Concrete	Masonry	Aluminum	Stainless	General																										
	<table border="1"> <thead> <tr> <th>Label</th> <th>E [ksi]</th> <th>G [ksi]</th> <th>Nu</th> <th>Therm ...</th> <th>Densit...</th> <th>Yield[k...</th> <th>Fu[ksi]</th> </tr> </thead> <tbody> <tr> <td>1</td> <td>A653 SS Gr33</td> <td>29500</td> <td>11346</td> <td>.3</td> <td>.65</td> <td>.49</td> <td>33</td> <td>45</td> </tr> <tr> <td>2</td> <td>A653 SS Gr50/1</td> <td>29500</td> <td>11346</td> <td>.3</td> <td>.65</td> <td>.49</td> <td>50</td> <td>65</td> </tr> </tbody> </table>								Label	E [ksi]	G [ksi]	Nu	Therm ...	Densit...	Yield[k...	Fu[ksi]	1	A653 SS Gr33	29500	11346	.3	.65	.49	33	45	2	A653 SS Gr50/1	29500	11346	.3	.65	.49	50	65
Label	E [ksi]	G [ksi]	Nu	Therm ...	Densit...	Yield[k...	Fu[ksi]																											
1	A653 SS Gr33	29500	11346	.3	.65	.49	33	45																										
2	A653 SS Gr50/1	29500	11346	.3	.65	.49	50	65																										

Fu (Ultimate) is the ultimate tensile stress.

Wood Specific Material Data

The **Wood** tab records a number of wood specific material properties that do not exist for the other materials. These entries are described below:

	Hot Rolled	Cold Formed	Wood	Concrete	Masonry	Aluminum	Stainless	General																																																																																																		
	<table border="1"> <thead> <tr> <th>Label</th> <th>Type</th> <th>Database</th> <th>Species</th> <th>Grade</th> <th>Cm</th> <th>Emod</th> <th>Nu</th> <th>Ther...</th> <th>Dens[k...</th> </tr> </thead> <tbody> <tr> <td>1</td> <td>DF</td> <td>Solid Sawn</td> <td>Visually Graded</td> <td>Douglas Fir-Larch</td> <td>No.1</td> <td><input type="checkbox"/></td> <td>1</td> <td>.3</td> <td>.3</td> <td>.035</td> </tr> <tr> <td>2</td> <td>SP</td> <td>Solid Sawn</td> <td>Visually Graded</td> <td>Southern Pine</td> <td>No.1</td> <td><input type="checkbox"/></td> <td>1</td> <td>.3</td> <td>.3</td> <td>.035</td> </tr> <tr> <td>3</td> <td>HF</td> <td>Solid Sawn</td> <td>Visually Graded</td> <td>Hem-Fir</td> <td>No.1</td> <td><input type="checkbox"/></td> <td>1</td> <td>.3</td> <td>.3</td> <td>.035</td> </tr> <tr> <td>4</td> <td>SPF</td> <td>Solid Sawn</td> <td>Visually Graded</td> <td>Spruce-Pine-fir</td> <td>No.1</td> <td><input type="checkbox"/></td> <td>1</td> <td>.3</td> <td>.3</td> <td>.035</td> </tr> <tr> <td>5</td> <td>24F-1.8E DF Balanced</td> <td>Glulam</td> <td>Table 5A</td> <td>24F-1.8E_DF_BAL</td> <td>na</td> <td><input type="checkbox"/></td> <td>1</td> <td>.3</td> <td>.3</td> <td>.035</td> </tr> <tr> <td>6</td> <td>24F-1.8E DF Unbalanced</td> <td>Glulam</td> <td>Table 5A</td> <td>24F-1.8E_DF_UNBAL</td> <td>na</td> <td><input type="checkbox"/></td> <td>1</td> <td>.3</td> <td>.3</td> <td>.035</td> </tr> <tr> <td>7</td> <td>24F-1.8E SP Balanced</td> <td>Glulam</td> <td>Table 5A</td> <td>24F-1.8E_SP_BAL</td> <td>na</td> <td><input type="checkbox"/></td> <td>1</td> <td>.3</td> <td>.3</td> <td>.035</td> </tr> <tr> <td>8</td> <td>24F-1.8E SP Unbalanced</td> <td>Glulam</td> <td>Table 5A</td> <td>24F-1.8E_SP_UNBAL</td> <td>na</td> <td><input type="checkbox"/></td> <td>1</td> <td>.3</td> <td>.3</td> <td>.035</td> </tr> </tbody> </table>								Label	Type	Database	Species	Grade	Cm	Emod	Nu	Ther...	Dens[k...	1	DF	Solid Sawn	Visually Graded	Douglas Fir-Larch	No.1	<input type="checkbox"/>	1	.3	.3	.035	2	SP	Solid Sawn	Visually Graded	Southern Pine	No.1	<input type="checkbox"/>	1	.3	.3	.035	3	HF	Solid Sawn	Visually Graded	Hem-Fir	No.1	<input type="checkbox"/>	1	.3	.3	.035	4	SPF	Solid Sawn	Visually Graded	Spruce-Pine-fir	No.1	<input type="checkbox"/>	1	.3	.3	.035	5	24F-1.8E DF Balanced	Glulam	Table 5A	24F-1.8E_DF_BAL	na	<input type="checkbox"/>	1	.3	.3	.035	6	24F-1.8E DF Unbalanced	Glulam	Table 5A	24F-1.8E_DF_UNBAL	na	<input type="checkbox"/>	1	.3	.3	.035	7	24F-1.8E SP Balanced	Glulam	Table 5A	24F-1.8E_SP_BAL	na	<input type="checkbox"/>	1	.3	.3	.035	8	24F-1.8E SP Unbalanced	Glulam	Table 5A	24F-1.8E_SP_UNBAL	na	<input type="checkbox"/>	1	.3	.3	.035
Label	Type	Database	Species	Grade	Cm	Emod	Nu	Ther...	Dens[k...																																																																																																	
1	DF	Solid Sawn	Visually Graded	Douglas Fir-Larch	No.1	<input type="checkbox"/>	1	.3	.3	.035																																																																																																
2	SP	Solid Sawn	Visually Graded	Southern Pine	No.1	<input type="checkbox"/>	1	.3	.3	.035																																																																																																
3	HF	Solid Sawn	Visually Graded	Hem-Fir	No.1	<input type="checkbox"/>	1	.3	.3	.035																																																																																																
4	SPF	Solid Sawn	Visually Graded	Spruce-Pine-fir	No.1	<input type="checkbox"/>	1	.3	.3	.035																																																																																																
5	24F-1.8E DF Balanced	Glulam	Table 5A	24F-1.8E_DF_BAL	na	<input type="checkbox"/>	1	.3	.3	.035																																																																																																
6	24F-1.8E DF Unbalanced	Glulam	Table 5A	24F-1.8E_DF_UNBAL	na	<input type="checkbox"/>	1	.3	.3	.035																																																																																																
7	24F-1.8E SP Balanced	Glulam	Table 5A	24F-1.8E_SP_BAL	na	<input type="checkbox"/>	1	.3	.3	.035																																																																																																
8	24F-1.8E SP Unbalanced	Glulam	Table 5A	24F-1.8E_SP_UNBAL	na	<input type="checkbox"/>	1	.3	.3	.035																																																																																																

Type - Currently there are four wood types available: Solid Sawn, Glulam, SCL (this includes LVLs), and Custom.

Database - Based on your **Type** selection, the **Database** menu will filter to the appropriate databases.

Species - Based on your **Database** selection, the **Species** menu will filter to the appropriate databases. This is the wood species designation from your selected design code.

Grade is the wood grade designation from your selected design code. This has a drop down list where you can select the appropriate grade.

The **Cm** check-box determines if the wet service / moisture content factor should be applied. If you put a check in the **Cm** field, the appropriate factors will be applied to the allowable stresses and Young's Modulus (E).

The **Ci** check-box determines if the incision factor should be applied. If you put a check in the **Ci** field, the appropriate factors will be applied to the allowable stresses and Young's Modulus (E).

Emod is a factor that is applied to the Young's modulus modifier to reflect the NDS Appendix F criteria. This is not applicable to the CSA O86 design code.

Note:

- Refer to [Custom Wood](#) to specify a custom wood material.

Commercial Species Groups:

When either the NDS 05/08, 12, 15, or 2018 wood design code is selected, the Solid Sawn Species menu lists two new species listed that are not specifically shown in the NDS code. These are the *Commercial Species Group I - DF/SP* and *Commercial Species Group II - HF/SPFe Fir*. These are meant to be simplified groupings of the most commonly used wood species. It is meant to simplify the selection procession for wood member design in the United States.

The design values for Group I take the NDS allowable stress values for two of the most widely used species (Doug Fir-Larch and Southern Pine) and uses the lower bound allowable stress value for each size and grade. To verify exactly what base allowable stress values were used, the user may review the properties in the [Member Double-Click](#) dialog.

Similarly, the design values for Group II take the allowable stress values for Hem Fir and Spruce-Pine-Fir and use the lower bound allowable stress values for each size and grade. To verify exactly what base allowable stress values were used, the user may review the properties in the [Member Double-Click](#) dialog.

Concrete Specific Material Data

The **Concrete** tab records a few concrete specific material properties that do not exist for the other materials. These entries are described below:

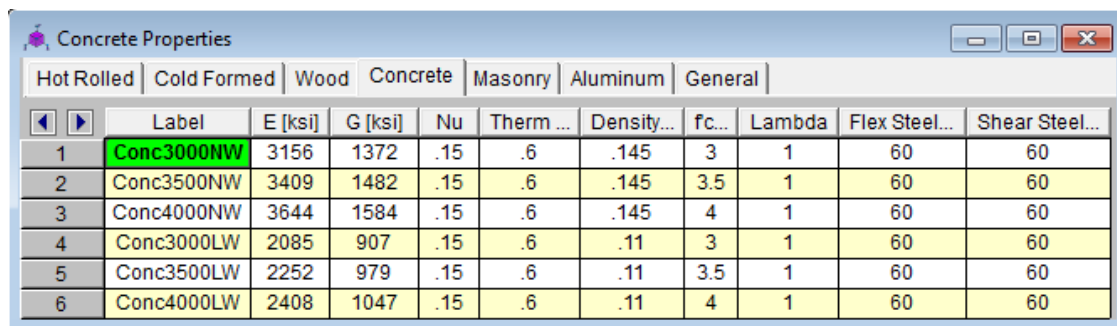

Concrete Properties										
Hot Rolled Cold Formed Wood Concrete Masonry Aluminum General										
	Label	E [ksi]	G [ksi]	Nu	Therm ...	Density...	fc...	Lambda	Flex Steel...	Shear Steel...
1	Conc3000NW	3156	1372	.15	.6	.145	3	1	60	60
2	Conc3500NW	3409	1482	.15	.6	.145	3.5	1	60	60
3	Conc4000NW	3644	1584	.15	.6	.145	4	1	60	60
4	Conc3000LW	2085	907	.15	.6	.11	3	1	60	60
5	Conc3500LW	2252	979	.15	.6	.11	3.5	1	60	60
6	Conc4000LW	2408	1047	.15	.6	.11	4	1	60	60

fc is the concrete compressive strength used for concrete design.

Lambda, λ is the lightweight concrete modification factor. This factor only applies to the *ACI 318-14*, *ACI 318-11*, *ACI 318-08* and *CSA A23.3-04* codes. For all other codes the Density value of the material determines any strength reduction. The program will automatically calculate the correct value if it is left blank. Only values between 0.75 and 1.0 will be considered.

Flex Steel is the reinforcement yield strength for flexural bars in members and vertical bars in walls. **Shear Steel** is the reinforcement yield strength for shear bars in members and horizontal bars in walls.

Masonry Specific Material Data

The **Masonry** tab records masonry specific material properties. Here we will describe items that do not exist for other materials.

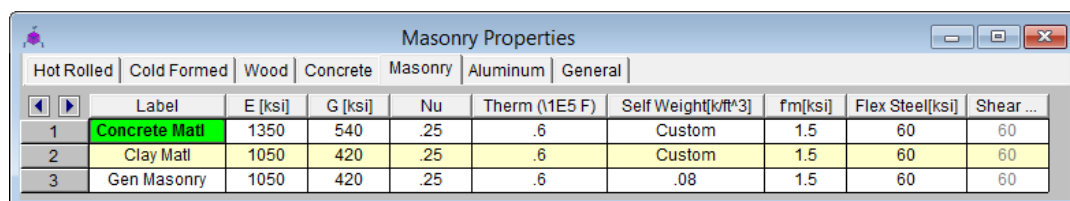

Masonry Properties									
Hot Rolled Cold Formed Wood Concrete Masonry Aluminum General									
	Label	E [ksi]	G [ksi]	Nu	Therm (1E5 F)	Self Weight[k/ft^3]	fm[ksi]	Flex Steel[ksi]	Shear ...
1	Concrete Matt	1350	540	.25	.6	Custom	1.5	60	60
2	Clay Matt	1050	420	.25	.6	Custom	1.5	60	60
3	Gen Masonry	1050	420	.25	.6	.08	1.5	60	60

Masonry **Self Weight** can be accounted for by two different methods. Entering a number for the density will result in masonry walls which have a self weight equal to that density multiplied by the wall cross-sectional area. Otherwise, click within the cell to launch the masonry self weight dialog:

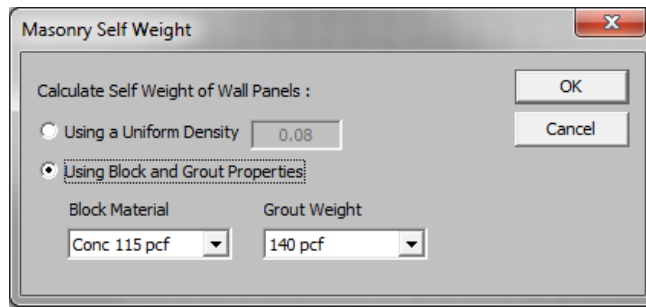

Set the Using **Block and Grout Properties** option to have the program automatically calculate the self weight of the wall using the weights from tableB3 of the Reinforced Masonry Engineering Handbook (RMEH). The self weight will be listed as **Custom**.

f_m is the masonry compressive strength used for masonry design.

Flex and **Shear Steel** are the rebar yield strengths for flexural and shear bars used to reinforce the masonry.

Note:

- Masonry Shear Steel is automatically set to the Flex steel strength.
- Masonry materials are used only for walls in wall footings. See the Wall Footing Definitions spreadsheet for more information.

Aluminum Specific Material Data

The **Aluminum** tab records a number of aluminum specific material properties that do not exist for the other materials. These entries are described below:

Aluminum Properties													
Hot Rolled Cold Formed Wood Concrete Masonry Aluminum General													
	Label	E [ksi]	G [ksi]	Nu	Therm ...	Density...	Table 3.3	kt	Ftu...	Fty...	Fcy...	Fsu...	Ct
1	3003-H14	10100	3787.5	.33	1.3	.173	Table 3.3-3	1	19	16	13	12	141
2	6061-T6	10100	3787.5	.33	1.3	.173	Table 3.3-4	1	38	35	35	24	141
3	6063-T5	10100	3787.5	.33	1.3	.173	Table 3.3-4	1	22	16	16	13	141
4	6063-T6	10100	3787.5	.33	1.3	.173	Table 3.3-4	1	30	25	25	19	141
5	5052-H34	10200	3787.5	.33	1.3	.173	Table 3.3-3	1	34	26	24	20	141
6	6061-T6 W	10100	3787.5	.33	1.3	.173	Table 3.3-3	1	24	15	15	15	141

Table B.4 is the table that refers to the Buckling Constants for a series of Temper designations. This column has a drop down list where you can pick from Table B.4.1 equations or Table B.4.2 equations.

Note: This table is named **Table 3.3** in ADM 05 and this column has a drop down list where you can pick from Table 3.3-3 equations or Table 3.3-4 equations.

k_t refers to coefficient for tension members listed in the ADM 10 Table A.3.3.

F_{tu} is the specified tensile ultimate strength.

F_{ty} is the specified tensile yield strength.

F_{cy} is the specified compressive yield strength.

F_{su} is the specified shear ultimate strength.

C_t refers to Buckling Constant Intersection for Axial Compression in Curved Elements per Table B.4.1 and Table B.4.2 ADM 10.

Stainless Steel Specific Material Data

The **Stainless** tab records stainless steel material properties. These entries are described below:

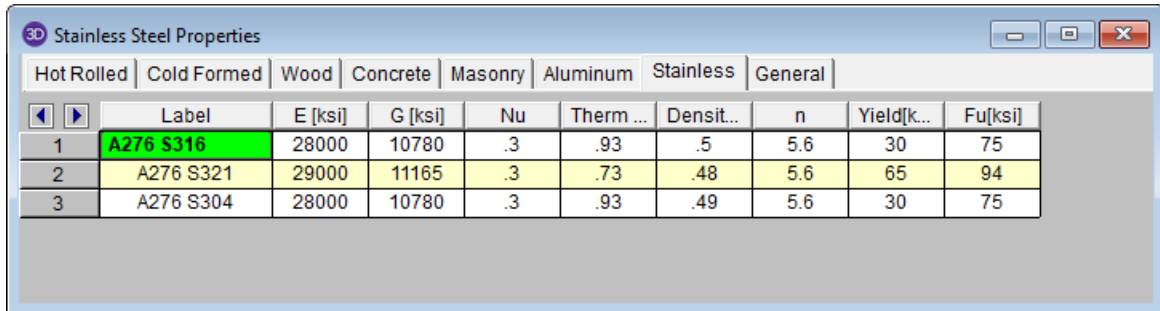

	Label	E [ksi]	G [ksi]	Nu	Therm ...	Densit...	n	Yield[k...]	Fu[ksi]
1	A276 S316	28000	10780	.3	.93	.5	5.6	30	75
2	A276 S321	29000	11165	.3	.73	.48	5.6	65	94
3	A276 S304	28000	10780	.3	.93	.49	5.6	30	75

n is the specified Ramberg Osgood parameter used for determining secant modulus. See AISC DG27 Table 6-1.

Yield is the specified yield stress.

Fu is the specified ultimate tensile stress.

Material Take-Off

Access the **Material Take-Off** spreadsheet by selecting it from the **Results** menu.

	Material	Size	Pieces	Length(ft)	Weight(K)
6	Hot Rolled Steel				
7	A36 Gr.36	LL8x8x8x3	10	168.5	9
8	A992	W10x12	15	268.5	3.2
9	A992	W10x17	6	108	1.8
10	A992	W12x40	7	84	3.3
11	Total HR Steel		38	629.1	17.4
12					
13	Cold Formed Steel				
14	A607_C1_55	4CS2x059	2	18	0
15	Total CF Steel		2	18	0
16					
17	Wood				
18	24F-1.8E SP Balance	2.5X5.5FS	1	18	0
19	DF/SPine	2-4X4	3	54	.3
20	DF/SPine	2-2X4	3	54.7	.1
21	DF/SPine	3X3	30	73.7	.1
22	DF/SPine	2X8	10	90	.2
23	Total Wood		47	290.5	.9
24					
25	Aluminum				
32	6061-T6	RT4X4X0.125	4	75.5	.2
33	6061-T6	RT6X6X0.125	4	49.9	.2
34	Total Aluminum		20	276	.2
35					
36	Concrete Members			Volume (yds*3)	
37	Conc3000NW	CRECT12X10	7	2.6	10.1
38	Conc4000NW	CRECT12X8	6	2.7	10.4
39	Conc4000NW	CRECT8X8	6	1.8	7
40	Conc4000NW	CRECT8x8	2	.6	2.3
41	Concrete Walls				
42	Conc3000NW		1	4.8	18.8
43	Total Concrete		22	12.4	48.7
44					
45	Plate Elements	Thickness (in)		Volume (yds*3)	
46	gen_Conc4LW	12	97	14.4	42.7
47	gen_Conc4NW	8	160	15.8	61.9
48	gen_Conc4NW	12	63	9.3	36.5
49	Total Plates		320	39.5	141.1

This spreadsheet shows material takeoff information for each material and shape in the model. For each material the shapes are listed with the total length and weight. The total length and weight for each material is summed beneath the listing of shapes.

The length listed is the sum of the lengths of all the members assigned to this shape. Member end offsets are deducted from the length. The weight is the sum of the self-weight for all elements assigned to section set. This weight is calculated as $\text{Area} * \text{Density} * \text{Length}$ for each member, again with offset distances deducted from the length.

For Concrete members and plates, the volume is shown rather than the length of the members.

Note:

- This material takeoff report is independent of the loads applied to the model, i.e. the applied loads do not influence this report.
- The number of pieces is reflective of the number of members of a particular size. For example, one double angle will be counted as one piece, with the length being the member length, and the weight being that of the double angle.
- Plates are also included in the Material Take-Off.

Members

RISA-2D uses a [Physical Member](#) that is automatically sub-meshed into general-purpose beam elements. With the use of the member [End Releases](#) you may define truss members or any other end condition for that matter. Member data may be viewed and edited in three ways: graphically in a model view, in the **Member Information Dialog**, or in the **Members Spreadsheet**. See [Members Spreadsheet](#) for descriptions of the member data. Design parameters for steel, wood or concrete design are recorded on the material tabs of the Members spreadsheet and are discussed in the [Hot Rolled Steel - Design](#), [Cold Formed Steel - Design](#), [Concrete - Design](#), and [Wood - Design](#) sections.

Drawing Members

To create new members you can draw them using a [Drawing Grid](#) or drawing "dot to dot" clicking existing joints. You can set all of the member properties up front or you can modify these properties after you draw the member. Graphically modifying properties is discussed in the next section.

The screenshot shows the 'Draw Members' dialog box with the following settings:

- Member Material Type and Shape:**
 - Material Type: Hot Rolled, Cold Formed, Wood, Concrete, Aluminum, Stainless, General
 - Assign a Section Set: HR1A
 - Assign Shape Directly:
 - Start Shape: W8x10
 - Type: Beam
 - Design List: Wide Flange
 - Material: A36 Gr.36
 - Design Rule: Typical
- Member Label Prefix:** M
- Joint Label Prefix:** N
- Release Codes:**
 - Fully Fixed at Both Ends
 - Pinned at Both Ends
- Both Ways:** Both Ways
- Physical Member:**
- Top of Member:**
- Orientation:** Rotate Section: 0
- Drawing Options:**
 - Draw Point to Point
 - Draw Beam to Beam
 - Draw Point to Beam
 - 1st Offset: 1 ft. %
 - 2nd Offset: 1 ft. %
 - Beam Offset: 1 ft. %
- Keep this dialog open
- Buttons: Apply, Close, Help

The Member Drawing Options are as follows:

Draw Point to Point

Use the first mouse click to select the start point of the new member. Use the second mouse click to select the end point of the new member.





Draw Point to Member

Use the first mouse click to select the start point of the new member. Use the second mouse click to select an existing member which would contain the end point of the new member. 'Beam Offset' is the offset of the end point of the new member from the start point of the existing member.

Draw Member to Member

Use the first mouse click to select an existing member which would contain the start node of the new member. Use the second mouse click to select an existing member which would contain the end point of the new member. '1st Offset' and '2nd Offset' are the location offsets of the start and end points of the new member from the start points of the existing members.

To Draw Members

1. If there is not a model view already open then click  on the **RISA Toolbar** to open a new view and click  to turn on the **Drawing Toolbar** if it is not already displayed.
2. If you are not drawing between existing joints, you will need to create a drawing grid or define joints on the **Joint Coordinates Spreadsheet**.
3. Click the  button and set the member properties. For help on an item, click  and then click the item.
4. Click **Apply** to start drawing members by clicking on joints, members or grids with the left mouse button. The coordinates of the closest joint or grid intersection to your cursor are displayed in the lower right hand corner of the status bar.

The first click will define the **I-end** of the first member. The second click, and each click thereafter, will define the **J-end** of the first member and also the **I-end** of the next member so that you may continue to draw as if your pencil is down. To "pick up" the pencil, click the right mouse button. You may then start drawing somewhere else with the left button.

The new members will be shown on screen and will be recorded in the **Members Spreadsheet**.

5. To stop drawing altogether click the right mouse button or press the Esc key.

Note





- Press CTRL-D to quickly recall the last dialog accessed and make changes.
- You may also specify or edit members in the **Members Spreadsheet**.
- You may undo any mistakes by clicking the **Undo**  button.

Modifying Member Properties

There are a number of ways to modify members. You may view and edit the member data in the [Members Spreadsheet](#). You may double-click a single member to view and edit its properties. You can use the **Modify Members** tool to graphically modify a possibly large selection of members.

The graphical **Modify Members** tool discussed here lets you modify the properties of members that already exist in your model. To use this, you will typically specify parameters you want changed, then select the members that you want to modify. You can modify members one at a time by selecting the **Apply by Clicking Individually** option and then click on the members you wish to modify. You may also modify entire selections of members by selecting the members in the model view first and then use the **Apply to All Selected** option. See the [Graphic Selection](#) topic for more on selecting.

To Modify Members

1. If there is not a model view already open then click  on the **RISA Toolbar** to open a new view and click  to turn on the **Drawing Toolbar** if it is not already displayed.
2. Click the **Draw/Modify Members**  button and select the **Modify Properties** tab.
3. Set the parameters for the new members. Check the **Use?** box for the items that are to be applied. For help on an item, click  and then click the item.
4. You may choose to modify a single member at a time or an entire selection of members.

To modify a few members, choose **Apply Entries by Clicking Items Individually**, click **Apply**, and click on the members with the left mouse button.

To modify a selection of members, choose **Apply Entries to All Selected Items** and click **Apply**.

Note

- To modify more members with different parameters, press CTRL-D to recall the **Modify Members Dialog**.
- You may also modify members in the **Members Spreadsheet**.
- To modify one member you may double click that member to view and edit its properties.
- To relabel members first sort the **Members Spreadsheet** into the desired order, select the **Tools Menu** and choose **Relabel Members**.
- You may undo any mistakes by clicking the **Undo**  button.

The parameters shown are nearly the same as those used to define new members.

The **Use?** check boxes next to the data fields indicate whether the particular parameter will be used or not when the modification is applied. If the box next to a field is checked, that parameter will be applied to any selected members, if the box is NOT checked, the parameter will NOT be applied, even if a value is entered in the field.

This lets you easily change one or two properties on members without affecting all the rest of the properties. Note that if no value is entered in a field (i.e. the field is blank) and the corresponding check box is checked, clicking **Apply** will have the effect of clearing the data for these fields. For example, to remove all member end-releases for the currently selected members, just erase any text in the I and J release fields, click their **Use?** check boxes so that they're checked, and then click on **Apply**.

Material and Cross Section Properties

Member material and cross section properties may be assigned to a member in one of two ways – either directly by specifying the shape and material explicitly, or by assigning a Section Set to the member. Section Sets allow you to control properties for a group of members that share the same properties. Combining section sets with the Member Redesign feature gives you great control over how new member sizes are picked and what members get updated. Section sets must be used when the desired shape is not in the database or when steel redesign (optimization) is desired. See [Section Sets](#) for more information.



All member properties may be assigned graphically either as you draw or later as a modification to the members.

Modifying Member Design Parameters

You can graphically specify the Hot Rolled, Cold Formed, Wood, Aluminum, or Concrete design parameters such as unbraced lengths and K factors. See [Steel Design](#), [Cold Formed Steel Design](#), [Concrete Design](#), [Aluminum Design](#), and [Wood Design](#) for information on the design parameters themselves.

To use this, you will specify the appropriate member parameters, then select the members that you want to modify, and then click on the "Apply" button. Alternately you can set the parameters and then choose the "Click to Apply" option, which allows you to then click on the members you want modified.

To Modify Member Design Parameters

1. If there is not a model view already open then click  on the **RISA Toolbar** to open a new view and click  to turn on the **Drawing Toolbar** if it is not already displayed.
2. Click the **Draw / Modify Members**  button and select the **Modify Design** tab.
3. Set the design parameters for the members. Check the **Use?** Box for the items to apply.
4. You may choose to modify a single member at a time or an entire selection of members.

To modify a few members choose **Apply Entry by Clicking Items Individually** and click **Apply**. Click on the members with the left mouse button.

To modify a selection, choose **Apply Entries to All Selected Items** and click **Apply**.

Note

- To modify more members with different parameters, press CTRL-D to recall the **Modify Members** settings.
- You may also specify or edit design parameters in the **Material** tab of the **Members Spreadsheet**.
- You may undo any mistakes by clicking the **Undo**  button.

The parameters shown are the same as those on the Hot Rolled, Cold Formed, Wood, Aluminum, or Concrete tab of the Members spreadsheet.

Design Parameters for Selected Members

Draw Members | **Modify Properties** | Modify Design | Split Members

Flexural Properties

Lb-comp/le-bend(top) [] ft Use?

Lb-comp/le-bend(bot) [] ft Use?

CH/w1-out [] Use?

Cm/w1-in [] Use?

Cb/w2/B [] Use?

R (AISI) [] Use?

C1 (Euro HR) [] Use?

Axial / Torsional Properties

Lb/le/Lu (out) [] ft Use?

Lb/le/Lu (in) [] ft Use?

Ltorque [] ft Use?

K-out [] Use?

K-in [] Use?

Concrete Properties

Icr Factor [] Use?

Eff Width Left [] in Use?

Eff Width Right [] in Use?

Slab Thick Left [] in Use?

Slab Thick Right [] in Use?

Shear Layouts Use Design [] Add Use?

Beam Layouts Use Design [] Add Use?

Column Layouts Use Design [] Add Use?

General / Misc Properties

Function (AISC) Lateral [] Use?

Design Rules Typical [] Use?

CV (NDS) [] Use?

Sway for out of plane bending Use?

Sway for in plane bending Use?

Cr (NDS) Use?

What happens when Apply is pressed?

Keep this dialog open

Apply Entries to All Selected Members

Apply Entries by Clicking Members Individually

Apply Clear Use Close Help

The **Use?** check boxes next to the data fields indicate whether the particular parameter will be used or not when the modification is applied. If the box next to a field is checked, that parameter will be applied to any selected members, if the box is NOT checked, the parameter will NOT be applied, even if a value is entered in the field. This lets you easily change one or two properties on members without affecting all the rest of the properties. Note that if no value is entered in a field (i.e. the field is blank) and the corresponding check box is checked, clicking "Apply" will have the effect of clearing the data for these fields. For example, to remove all member end-releases for the currently selected members, just erase any text in the I and J release fields, click their **Use?** check boxes so that they're checked, and then click on "Apply".

Splitting Members

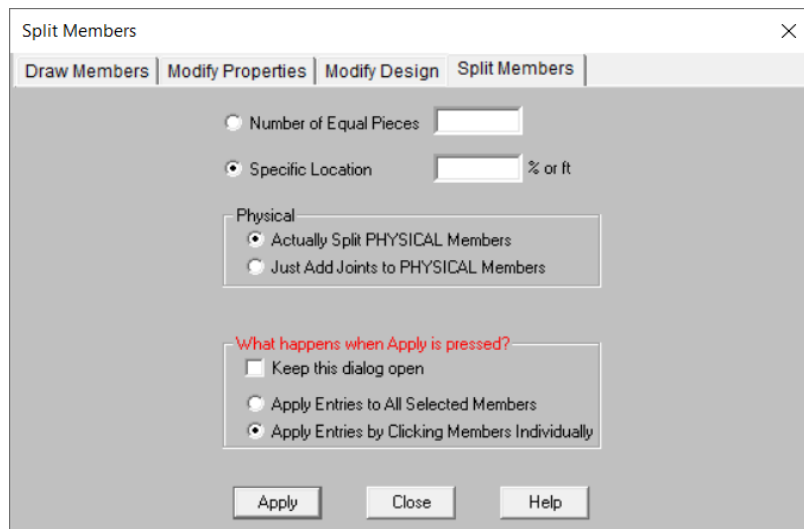

You can split members into a number of equal length pieces or you may split into two members at a specified location from the I joint. You may specify the split location as a length or a percentage of length. For example specifying %50 will split the members at the midpoints.

You may choose between **Add Joints to Physical Members** and **Actually Split Physical Members**. For Physical members it is likely that you will not want to actually split the member but prefer instead that joints be placed along the member so that you may specify other members, plates, loads or boundary conditions.



If you use both parameters at the same time, each parameter will be applied independently to the original member. For example if you specify '3' equal pieces and also specify a split at '%50', you will get a member that is broken up in 3 places. There will be 2 breaks at its third points, and also a break that would be at the middle (50% of the length) of the original member.

To Split Members

1. If there is not a model view already open then click  on the **RISA Toolbar** to open a new view and click  to turn on the **Drawing Toolbar** if it is not already displayed.
2. Click the **Draw / Modify Members**  button and select the **Split Members** tab.
3. Set the parameters for splitting the members.
4. You may choose to modify a single member at a time or an entire selection of members.

To modify a few members choose **Apply Entry by Clicking Items Individually** and click **Apply**. Click on the members with the left mouse button.

To modify a selection, choose **Apply Entries to All Selected Items** and click **Apply**.

Note

- To modify more members with different parameters, press CTRL-D to recall the **Split Members** settings.
- You may undo any mistakes by clicking the **Undo**  button.

Members Spreadsheet - Primary Data

The **Members Spreadsheet** records the properties for the member elements and may be accessed by selecting **Members** on the **Spreadsheets Menu**.

	Label	I Joint	J Joint	Rotate...	Section/Sh...	Type	Design List	Material	Design Rules
1	M1	N1	N2		HR1A	Beam	Wide Flange	A992	Typical
2	M2	N3	N4		CF1A	Beam	CU	A653 SS Gr33	Typical
3	M3	N5	N6		WOOD1A	Beam	Rectangular Double	DF	Typical
4	M4	N7	N8		CONC1A	Beam	Rectangular_MM	Conc3000NW	Typical
5	M5	N9	N10		CONC2	Column	Rectangular	Conc3000NW	Typical
6	M6	N11	N12		AL1A	Beam	C Channel	3003-H14	Typical
7	M7	N13	N14		SS1A	Beam	Wide Flange Default	A276 S316	Typical
8	M8	N15	N16		GEN1A	Beam	None	gen_Conc3NW	Typical

The following data columns hold the **Primary** data for the members:

Member Labels

You may assign a unique **Label** to any or all of the members. You can then refer to the member by its label. Each label has to be unique, so if you try to enter the same label more than once you will get an error message. You may relabel members at any time with the **Relabel Members** option on the **Tools Menu**.

Member End Joints

The **I-Joint** and **J-Joint** entries define the start (I-joint) and end (J-joint) locations of the member. The member local axes are defined based on these joints. See [Member Local Axes](#) for more information.

X-axis rotation

The **Rotate** column is used to define the orientation of the member cross-section. You may specify 0, 90, 180 or 270 degree rotations. See [Member Local Axes](#) and [Defining Member Orientation](#) for more information.

Section / Shape

If you are explicitly assigning shapes to each member, then enter the database shape you wish to use for the member. You can select this by clicking on the arrow in the cell. Alternatively, you may choose a section set to represent the section properties, material properties, and re-design parameters.

Member Type

If you are explicitly assigning shapes to each member, then you may enter the **member type** that you wish to use. The choices are *Column*, *Beam*, *Vertical Brace*, and *Horizontal Brace*.

Here are the main effects that the member type will have on your structure:

- 1) If you are using concrete, this will define the rebar layout (column vs beam) .
- 2) If you are using design lists, they specifically reference the member type.
- 3) If you are using member area loads, loads will not be attributed to members defined as Hbraces or Vbraces.
- 4) If you are using flexible diaphragms, transient loads will not be attributed to members defined as None, Columns or Vbraces.
- 5) If you are using the RISA-Revit link the link will not work properly unless you use member types.
- 6) If you are integrating with RISACONNECTION, the connection validation requires proper use of member types.
- 7) If you are using the seismic detailing provisions then you must use proper member types.

Note

- If you are using **Section Sets** to define your member, then the information in this field will be generated automatically based on the referenced section set.

Design List

If you are explicitly assigning shapes to each member, then you may enter the **design list** type that you wish to use. This entry will affect the members that are available to program when it is suggesting alternate or optimized shapes. Refer to [Design Optimization](#) for more information on the member optimization procedure. Also refer to [Appendix A - Redesign Lists](#) for information on creating or editing these lists.

Note

- If you are using **Section Sets** to define your member, then the information in this field will be generated automatically based on the referenced section set.

Material

If you are explicitly assigning shapes to each member, then you may enter the **material** that you wish to use. You can select this by clicking on the arrow in the cell.

Note

- If you are using **Section Sets** to define your member, then the information in this field will be generated automatically based on the referenced section set.

Design Rules

If you are explicitly assigning shapes to each member, then you may enter the **design rules** type that you wish to use. When the program is checking alternate or optimized shapes, it will restrict its selections to members that obey the chosen design rules. Refer to [Design Rules- Size / U.C.](#) for more information.

Note

- If you are using **Section Sets** to define your member, then the information in this field will be generated automatically based on the referenced section set.

Members Spreadsheet - Advanced Data

The **Advanced** tab records the properties for the member elements and may be accessed by selecting **Members** on the **Spreadsheets Menu**.

	Label	I Release	J Release	I Offset[in]	J Offset[in]	T/C Only	Physical	Defl R...	TOM	Inactive
1	M1	PIN	PIN				<input checked="" type="checkbox"/>		<input type="checkbox"/>	
2	M2	PIN	PIN				<input checked="" type="checkbox"/>		<input type="checkbox"/>	
3	M3						<input checked="" type="checkbox"/>		<input type="checkbox"/>	
4	M4						<input checked="" type="checkbox"/>		<input type="checkbox"/>	
5	M5						<input checked="" type="checkbox"/>	** NA **	<input type="checkbox"/>	
6	M6						<input checked="" type="checkbox"/>		<input type="checkbox"/>	
7	M7					Tension Only	<input checked="" type="checkbox"/>		<input type="checkbox"/>	
8	M8					Tension Only	<input checked="" type="checkbox"/>		<input type="checkbox"/>	

The following data columns hold the **Advanced** data for the members:

I and J Releases

Releases control the forces that may be resisted by a member. You may use these to define pinned connections, truss members, and any other end condition. See [Member End Releases](#) for more information.

I and J End Offsets

End offsets may be used to model a rigid end zone for a member. See Member [End Offsets](#) for more information.

T/C Members

The T/C field is used to indicate that a member is to be Tension or Compression only. When a member is flagged as C, any members it will only be able to take compressive loads. The member will have no stiffness to resist tensile loads. When a member is flagged as T, the member will only be able to take tension loads. When a section is flagged as E, the member will primarily take only tension loads, however it will also take some compression load, up to its Euler buckling load.

Physical

This box is checked if the member is a Physical Member. See [Physical Members](#) for more information.

Defl Ratio Options

This option is only applicable to members designated as beams. This field is used to designate the member end behavior either as supported or as a cantilever for the deflection ratio. If this field is blank, deflection ratio will be based on original member behavior. See [Deflection Ratio Options](#) to learn more.

Top of Member Offset

Members may be offset downward by half their depth for analysis. This is useful for aligning all of your beams to the same top of steel elevation. See [Top of Member Offset](#) to learn more.

Inactive Members

Members may be removed from the solution without deleting them from your model by making them inactive. See [Inactive and Excluded Elements](#) for more information.

Tension/Compression-Only Members

Members in RISA by default are allowed to take both tension and compression. However, some design or modeling practices may require you to define specific members as either *Compression Only* or *Tension Only*. Here we will define what each of the T/C Only options means.

Both Ways

This is the default behavior. In this scenario a member will be allowed to take either compression or tension and the program will base the combined bending and axial code checks on these forces.

Tension Only/Euler Buckling

Tension-only behavior is just as it sounds. When a member is defined as tension-only the program will allow these members to only resist tension forces. If the load path introduces compression forces into the member, then it will be removed from the stiffness matrix and another solution will be run.

Note

- To avoid stability issues, the program will allow the Tension Only member to resist a very small percentage of compression in the member. By allowing the member to take 1e-8 of the member's stiffness in resistance to compression, the program can avoid model instabilities which would be caused by removing the Tension Only member all together.
- Tension-only member code checks will ONLY consider axial tension. Bending forces will NOT be used when computing code checks.

Euler Buckling

An option similar to tension-only is the Euler buckling option. This option is used as a replacement to tension-only and allows a member to take up to the Euler buckling capacity of the member in compression before it is removed.

The reason for the Euler buckling option is that allowing tension-only members to take a little compression helps model convergence greatly. Generally speaking, tension-only members are generally very slender members that have a small Euler buckling capacity. The intent of this option is to allow a very small amount of compression to get into your members so you don't get unstable models.

Note

- Euler buckling member code checks will ONLY consider axial tension. Bending and compression forces will NOT be used when computing code checks.
- You can control the amount of compression that an Euler buckling member takes by artificially increasing or decreasing the Kl/r ratio that is used to calculate the Euler buckling load. The best way to alter the Kl/r ratio is to modify the L_b parameters for that member on the Hot Rolled, Cold Formed or Wood tabs of the **Members** spreadsheet.
- Using this option for members with high Euler buckling capacities is generally not appropriate and may lead to unconservative results.

Compression Only

Compression-only behavior is just as it sounds. When a member is defined as compression-only the program will allow these members to only resist compression forces. If there are tension forces then the member will be removed and another solution will be run.

Note

- To avoid stability issues, the program will allow the Compression Only member to resist a very small percentage of tension in the member. By allowing the member to take 1e-6% of the member's stiffness in resistance to tension, the program can avoid model instabilities which would be caused by ignoring the Compression only member all together.
- Compression-only member code checks will ONLY consider axial compression. Bending forces will NOT be used when computing code checks.

Iterative Solution Considerations

When a model contains T/C only members, the program must iterate the solution until it converges. Each iteration is a solution of the model. After each solution the program checks T/C only member forces. If a tension-only member has compression then this member has it's stiffness reduced down to 1e-8% of it's original stiffness so it will take no forces. If an Euler buckling member has a compression greater than its Euler buckling load this member has it's stiffness reduced down to 1e-8% of it's original stiffness. If a compression-only member has tension then this member has it's stiffness reduced in a similar fashion. After these member stiffnesses are reduced the stiffness matrix is re-built and another solution is run.

In subsequent solutions members can have their stiffnesses both removed and added back in. Reducing the stiffness of members is the identical process just explained. Adding member stiffness back in can occur for

members that have been previously reduced. The program will look at the distance between the end nodes which define the previously reduced member. From this distance the program can calculate whether that member would now be in compression or tension. Let's take a tension-only member that had its stiffness reduced due to the presence of compression in the first iteration. In the 2nd iteration if the distance between the nodes defining the member got longer than it was in iteration one, this would signify that the member would now be in tension. Thus, for the next iteration the program would place this member back in the stiffness matrix. Because of this iterative solution, models with T/C only members can take a bit longer to solve than a regular static solution.

Note

- If a member has its stiffness reduced, it will still show up in the results. However, the forces and code checks for this member will all be zero.
- For X-bracing that is set to either tension-only or Euler buckling, do not place a node at the intersection of these braces. You will likely have convergence problems in this case and receive error code 1162.

Instability Considerations

For members defined as tension-only you can run into problems with instabilities for gravity-only LC's. For example, let's take a look at an x-braced frame where the x-bracing is defined as tension-only. For a lateral load combination, the tension-only feature works great.

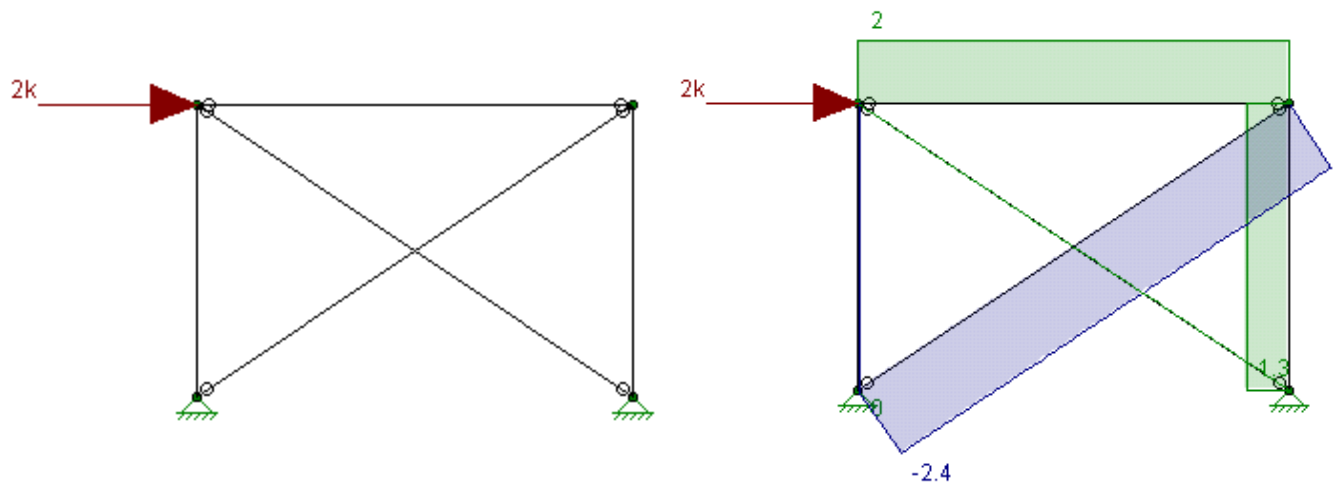

In the image above we can see that the "compression" brace has no force in it because it has its stiffness reduced in the stiffness matrix and that all of the load is passing through the "tension" brace.

However, if we are looking at a gravity load combination, this results in an instability.

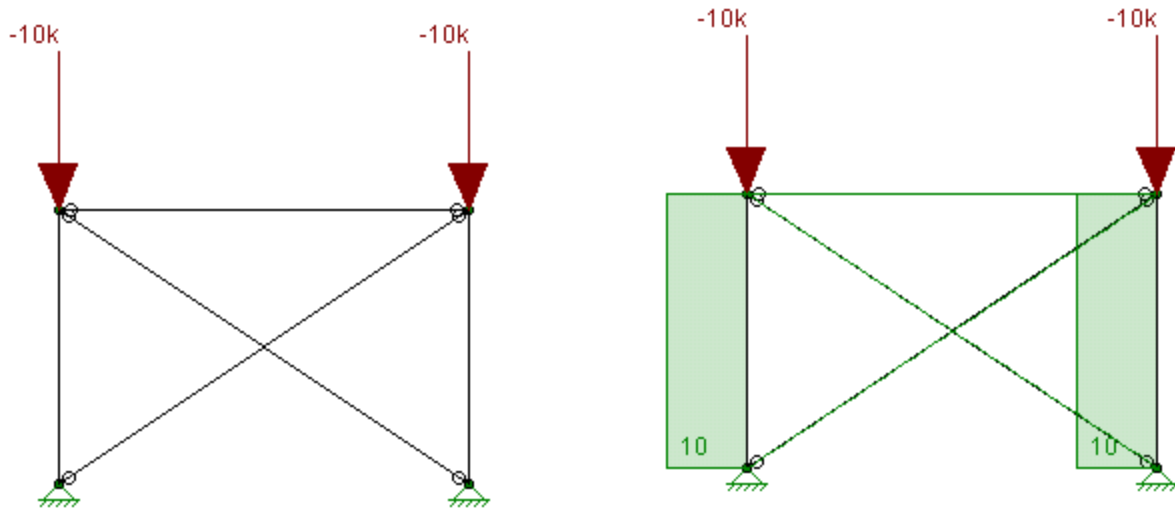

In this scenario the columns in this model undergo a small amount of axial shortening. This induces a small amount of compression and both of the tension-only braces have their stiffnesses reduced. This results in a frame that is unstable and illustrates the problem. The solution here is to use Euler buckling braces.

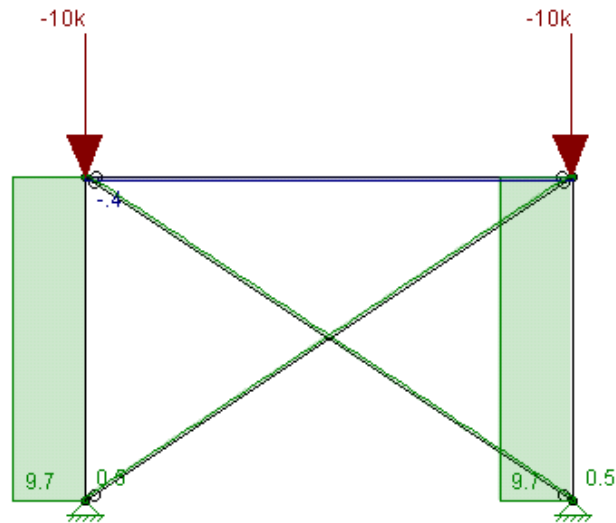

In this case these braces are taking about 500 lbs of compression, a relatively small amount. As long as this value is small then we can still consider these as tension-only members.

Note

- Shear effects are considered for all T/C Only member options in separate code checks for shear.

Member Information Dialog

Just as with the joints and plates you may double-click any member to view its properties. All of the same information that is stored in the **Members** and **Member Design** spreadsheets is displayed for the member you choose, and may be edited. This is a quick way to view and change member properties. For large selections of members however the spreadsheet and graphic editing tools may be the faster solution.

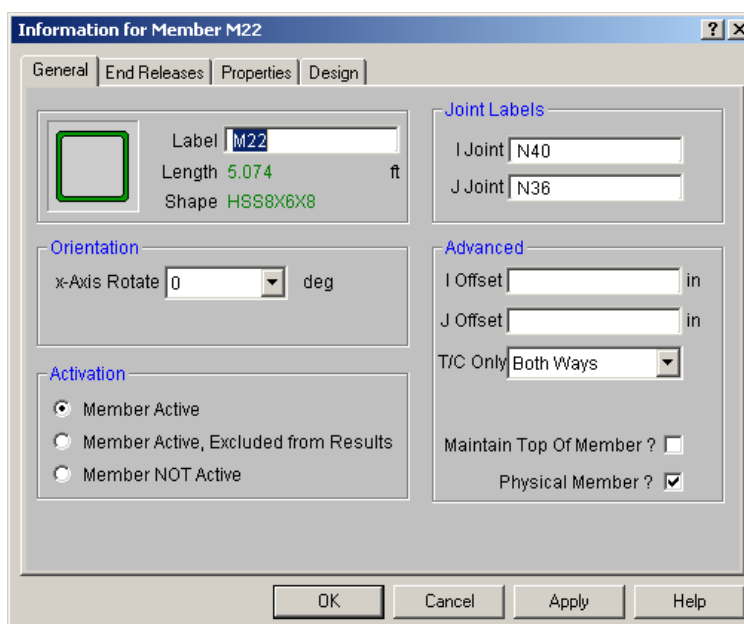

General - This tab let's you view edit the member's label and end joints. The rigid end offsets, orientation, and activation state can also be viewed and modified here. The shape pictured will change depending on the shape type of the member. It will also change to reflect wood members. If the member is made inactive here, you will need to activate the member from the Members spreadsheet, or by using the Criteria Select feature to find and select inactive members.

End Releases - This tab allows you to view and modify the end releases for the member. It also allows you to define Connection Rules for your hot-rolled steel connection design to be used in conjunction with RISACONNECTION. See the RISACONNECTION Integration topic for more information.

Properties - This tab lets you view and edit the member's section set. The type of material information displayed will change depending on whether the section set material properties are defined on the General Materials spreadsheet.

Design - This tab allows you to view and edit the design properties for the member. The types of design information will change depending on the material type of the member and the code setting on the Model Settings window.

Detailing - This tab is specifically for you with the [CIS\2 translator](#) export application. THIS TAB DOES NOT AFFECT ANALYSIS

Note

- It's generally more efficient to use the Graphic Editing features if you want to change the properties for many members at once.

Physical Members

Physical Members provide fixity to all joints that occur along the length of the member, without breaking that member into multiple smaller members. You may use the physical member feature to avoid defining one 'field' member with multiple members in your model. This saves time in building and editing your model and in understanding your results.

To define a Physical Member, check the Physical Member box in the **Set Member Properties** settings or in the **Modify Member Parameters** settings. You may also specify Physical Members in the **Members Spreadsheet** and in the **Member Information** settings.

To understand the benefits of Physical Members see the trusses in the following figure. The first truss shows the chords modeled without physical members and thus with **multiple** members modeling each chord. The second truss models each chord with **one** Physical Member. Both models will yield the same results. However the Physical Member model is more intuitive and easier to work with because you don't have to work with multiple members when you create the chords, load them, edit them or evaluate their results. Notice that the distributed load may be defined from start to end for the Physical Member. In the other model the distributed load end magnitudes have to be specified for each of five members in order for the entire load to be defined.

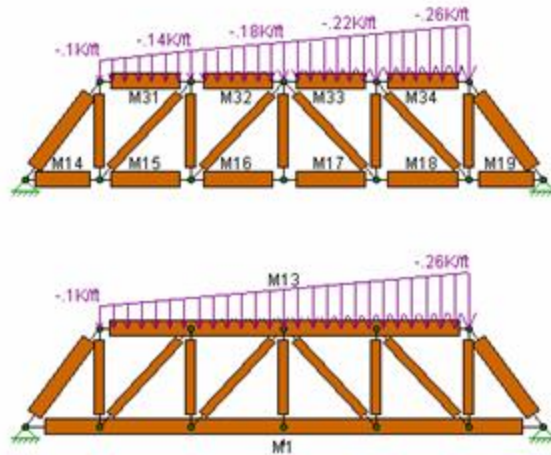

Continuous beams, multi-story columns and truss chords are examples of continuous 'field' members that can be modeled with one Physical Member. You may define them from start to finish without having to explicitly define their connection to other elements or boundaries through intermediate joints. Subsequently, when it comes time to make changes to a member you can edit the properties of one Physical Member rather than the multiple members that might otherwise represent it.

Physical Members are also effective in managing results because the results for one Physical Member are reported together in the results spreadsheets and the member detail report. With the truss example above the Physical Member model allows you to look at results for one member making it easier to track maximum forces and other values.

Note

- You may convert a Physical Member into multiple members by removing the Physical Member property and then performing a Model Merge to split the member for connectivity. See [Model Merge](#) for more information.
- You cannot convert multiple members into one Physical Member. To achieve this you must delete the multiple members and define a new Physical Member.

For additional advice on this topic, please see the RISA Tips & Tricks webpage at risa.com/post/support. Type in Search keywords: **What are Physical Members**.

Member Local Axes

The following diagram illustrates the directions of the member's local axes that are used to define member forces, stresses, and deflections as well as loads defined in local axes directions:

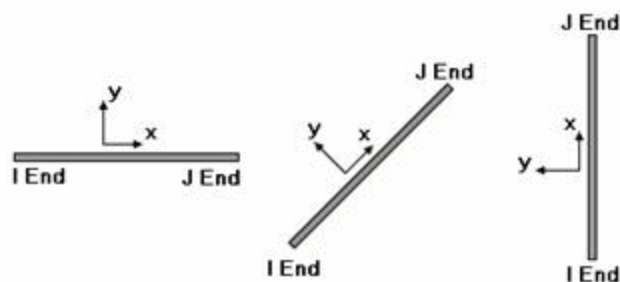

As can be seen from the diagram, the local x-axis corresponds to the member centerline. The centerline designates the member cross section's centroid location. The positive direction of this local x-axis is from the I-joint towards the J joint. The local z-axis is always normal to the plane of the model with positive z being towards you. The local y-axis is then defined by the right-hand rule.

Defining Member Orientation

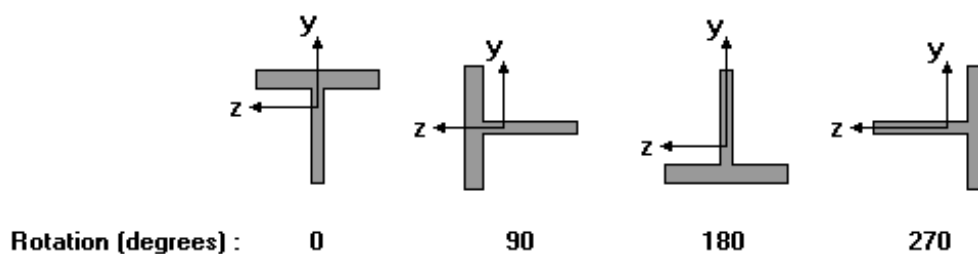

In RISA-2D if you do not explicitly define the orientation for the member, the usual default is for the member to bend about its "strong axis". The third column on the Members spreadsheet, **Rotate**, is used to define the orientation of the member cross-section. You may specify 0, 90, 180 or 270 degree rotations.

As an example, to have a wide flange (WF) member bend about its strong axis this field should be left blank or set to "0". To have a WF bend about its weak axis, enter a "90" in this field.

For another example consider a Tee shape as shown below. Remember that when modeling the local z-axis is always towards you.

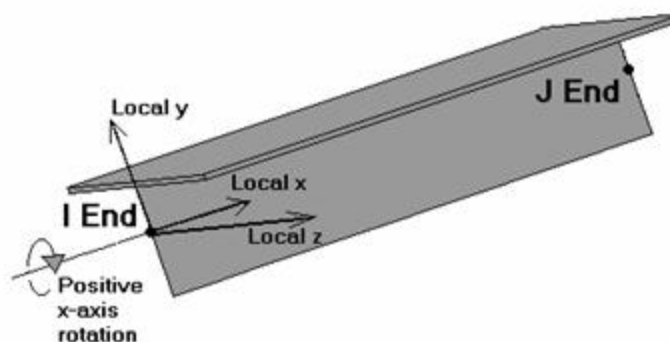

Note

- To be sure of a member's orientation you can always view the rendered shape of a member by clicking the  button on the **Window** toolbar.

Member End Releases

The **I Release** and **J Release** fields are used to designate whether the forces and moments at the ends of the member are considered fixed to or released from the member's points of attachment (the I and J joints). Each member has 3 force components at each end (axial, shear, and bending). Any or all of these force components can be released from the member's point of attachment. If a force component is released, that force is not transferred between the joint and the member.

To specify member releases go to the **I Release** or **J Release** field for the member in the Members Spreadsheet on the Advanced Tab, click the  button, and specify the condition.

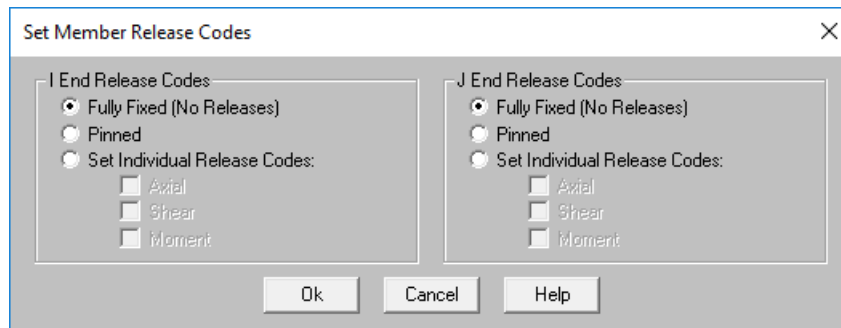

Alternatively, you may specify the end condition by directly typing in the field. To indicate that a force component is released, put a **X** for that component in the release field. You can move within the release field using the space bar which will result in a **O** for no release.

RISA-2D has a special "keyword" release configurations built-in. This is:

PIN => M(bending only) released (OOX)

This keyword entry is included because 99% of the release configurations you'll ever want to define will be one of these two (98% will be BenPIN). You can call out the keyword entry by just entering the first letter of the keyword. So if you go to a release field and enter "bp", the keyword "BenPIN" will be filled in automatically.

For additional advice on this topic, please see the RISA Tips & Tricks webpage at risa.com/post/support. Type in Search keywords: **End Release**.

Deflection Ratio Options

The **Beam Deflection Ratio** can be used during member design to check the deflection criteria. By default, the program will determine whether a member is a cantilever or is supported on both ends. In certain cases where the beam should be considered otherwise, more control over these support types for a beam can be designated in the **Deflection Ratio Options**. This feature is only applicable to members designated as "beams" and only affects the beam deflection ratios located in the [Beam Deflection](#) tab of the **Member Deflections** spreadsheet.

The option to set the support type for the beam deflection ratio can be applied from any of the following locations:

- Member Double-click dialog
- Members Spreadsheet \ Advanced Tab
- Modify Members dialog

Clicking the  button in the spreadsheet brings up the following dialog box:

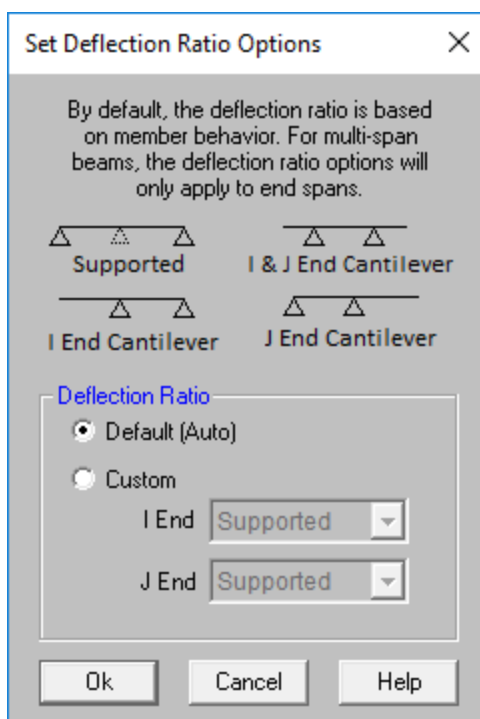

Single span beams can be designated as supported on both ends, or cantilever on either I- or J- end. Multi-span beams have an additional option to be cantilever on both I- and J- end. A double cantilever option is available for multi-span beams since internal supports will support the beam. Designating member ends as either supported or cantilever will affect only the beam relative deflection and also determine which equation is used when calculating beam deflection ratios. See [Beam Deflections](#).

For a member supported on both ends, the maximum relative displacement used in the beam deflection ratio will be the largest straight line distance (in the vertical y direction) between the deflected shape and the original undeflected shape.

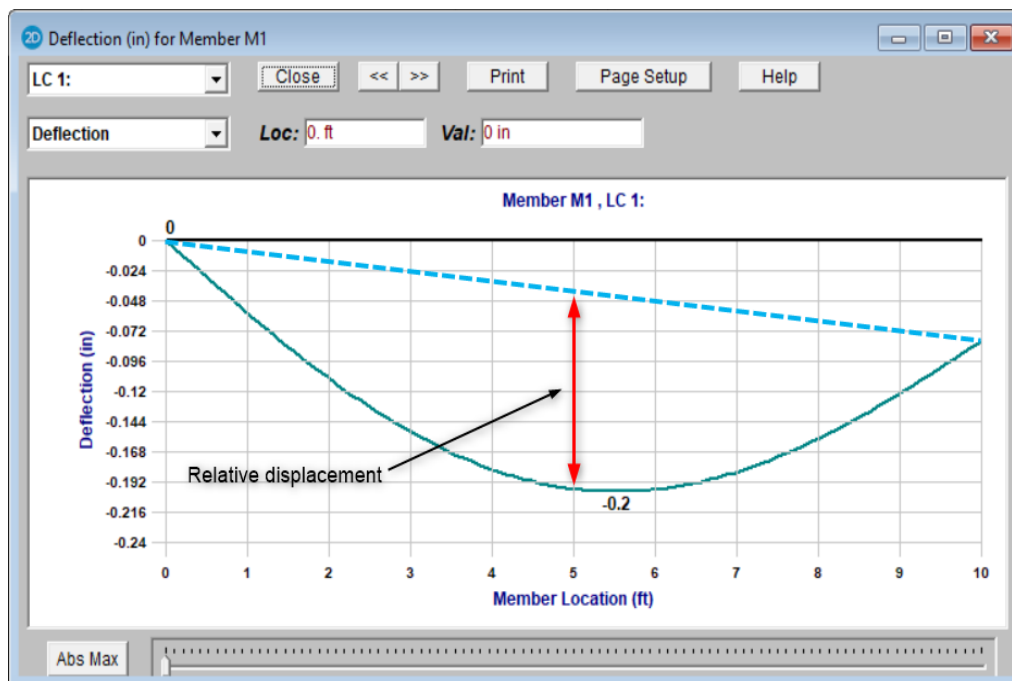

For members with a cantilever end, the location of the maximum relative deflection will be at the free end of the member. The displacement value is equal to the rotation at the supported end multiplied by the length of the member.

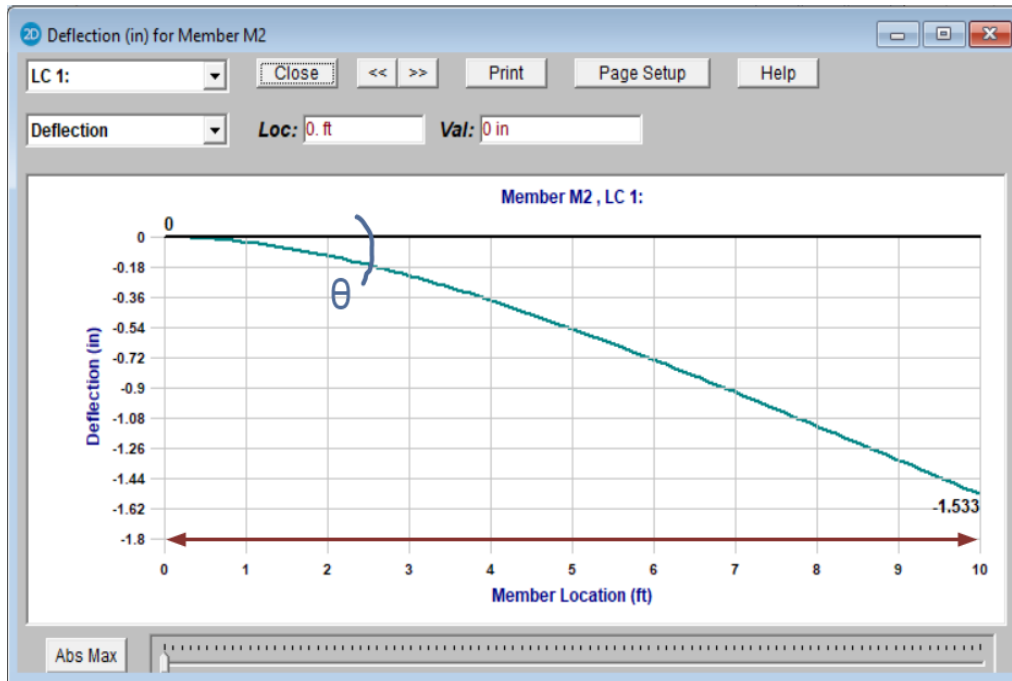

Note

- Designating specific member end support types for the beam deflection ratio will not affect global deflection or the member deflection ratios located in the [Service](#) and [Strength](#) tabs of the Member Deflections spreadsheet.
- For additional information on this topic, please see the RISA Tips & Tricks webpage at risa.com/post/support. Type in Search keywords: **Deflection Ratio**

Top of Member Offset

The Member Top Offset is an offset applied downward to the member which acts to make the top of the member line up with the end joint elevation (i.e. the end joint elevation becomes the “top of the member”). When the TOM flag is checked on the Advanced tab of the Members spreadsheet, RISA-2D first calculates the distance from the member centroid to its extreme top fiber (in the current configuration) then offsets the member that distance in the negative Global vertical direction.

This feature reflects the fact that members may be aligned by their faces rather than by their centerline elevations such as when you have a W24 and a W12 framing into the same column. Members with this flag set will be offset downward (in the negative vertical direction) from their joint endpoints. The distance of the offset will be the distance from the centroid to the top of the beam. For example, a beam in strong axis bending will be offset half its depth. A beam turned 90 degrees so that it is in weak-axis bending will be offset by half its width. For singly-symmetric sections such as single and double angles and WTs, RISA-2D will correctly identify the member orientation and vertical offset distance necessary to properly align the member’s “top” edge. This offset affects the member stiffness and results. All member results for offset members will be reported at the ends of the member, not at the joint locations.

Note

- Top of member offsets only apply to members that are running perpendicular to the vertical direction and have their local y or local z axes parallel to the vertical direction.

- Combining top of member offsets with rigid elements such as boundary conditions and rigid links often gives undesirable behavior such as large axial loads in the offset members.
- Using this feature on braced frames (or on any beams that have a diagonal member framing into them) will introduce eccentric moments and axial loads into the beam and is generally not recommended.
- Top of member offsets can not be used on tapered members. You may wish to provide rigid links similar to the automated way it is being done, but be aware of the limitations.

Member End Offsets

Member offsets reflect the fact that the member ends may not be attached at the centerline of the member being attached to. For example, a beam connected to the flange of a column is offset from the centerline of the column. The distance of the offset would be $\frac{1}{2}$ the depth of the column.

You may enter explicit offset distances or have them calculated automatically. To enter offsets explicitly simply enter the value of the offset. To have the offset calculated, enter the non-numeric label of the member whose depth defines the offset distance.

For example, say your member is framing into the flange of a 12" deep column. The offset distance would be 6", so you would enter '6' for the offset. Now, if that column gets changed to a 14" shape, you would have to go back and change the offset distance to 7". This can be time consuming if you have many offsets.

If instead the column has a label of M100, specifying M100 as the member offset causes the offset to be calculated as half of the depth of the member M100. For the W12 column the offset would be 6" and when the column is changed to a W14 the offset becomes 7".

Note

- When you use a member label to define the end offset, this value is ALWAYS taken as simply the depth of the member. Thus, if you are framing at an angle into a member or into the weak axis of a member you should not use this feature.
- When the model is solved the member length is adjusted in the stiffness matrix by the offset distance resulting in a shorter, stiffer member. Also the results listed for members with offsets do take into account the offset distances. The I-end and J-end results are the results at the offset locations, and the report locations are determined by dividing the member length minus the offset distances by the **Number Of Sections** on the **Model Settings**.

For additional advice on this topic, please see the RISA Tips & Tricks webpage at risa.com/post/support. Type in Search keywords: **Offsets**.

Inactive and Excluded Elements

Making an element, such as a member, plate or wall panel, inactive allows you to analyze the structure without the item, without having to delete the information that defines it. This leaves data intact so the item may be easily reactivated. This is handy if you want to try a frame with and then without certain items, without having to actually delete the data.

Making an element **Inactive** means the item is not included when the model is solved or plotted.

Making an element **Excluded** means the item is in the solution, but excluded from the results list. An excluded item will be treated like any other member in the solution and plotting of the model, but the item will not be listed in the solution results (forces, stresses, deflections, etc.). This is useful if there are certain items whose results you're not interested in. You don't have to clutter up the results with these items and can concentrate on the items you're most interested in. See [Printing](#) for more limiting printed results.

Note

- When making elements inactive you may need to update the unbraced lengths of the adjacent members.

Member Shear Deformations

Including shear deformation models the effects of shearing forces on the lateral displacements of the members. Shear deformation is included in the analysis by checking the appropriate box on the **Model Settings**.

Shear deformation effects are based on the material shear modulus (G) and the shear area.

Including shear deformation causes the member stiffness matrix to be modified by the term M, where:

$$M := \frac{12 \cdot E \cdot I}{G \cdot A_s \cdot L^2}$$

Where $A_s = \text{Area} \cdot \text{Shear Deformation Factor}$

These shear area coefficients will be automatically calculated for all standard members, but must be entered for arbitrary sections. While these shear deformation factors are always less than 1.0, they can vary from 0.85 for solid rectangular shapes, to 0.88 for solid circular shapes, to 0.53 for thin pipes. These coefficients are used strictly for shear deformation effects and should not be confused with shear stress factors described in the next section. A good reference for the calculation of both of these coefficients is ***Stress, Strain, and Structural Matrices*** by Walter D. Pilkey.

For members whose length is much greater than the depth, shear deformation has a relatively minor impact. When the length of the member is less than 10 times its depth, shear deformation begins to have a significant impact on the solution. Keep this in mind if you are creating models where members are being broken up into several pieces because the length used to calculate the term M is the joint-to-joint member length.

Note

- Shear deformation effects are included for the joint deflections only and not for the internal member deflections.
- Shear deformation effects are included for joint loads and not for member point loads.
- Shear deformation can play a significant role in the stiffness of the member and thus the results.

Member Shear Areas

The equation for calculating shear area varies for different shape types:

- For WT, LL, L, $A_v = (\text{depth} \cdot \text{thickness}) / 1.2$
- For channel, $A_v = (\text{depth} \cdot \text{thickness}) / 1.0$
- For rectangular tube, $A_v = (2 \cdot \text{depth} \cdot \text{thickness}) / 1.0$ for AISC 360-05 (13th edition) and AISC 360-10 (14th edition), but $(2 \cdot (\text{depth} - 3 \cdot \text{web thickness}^2)) / 1.0$ for AISC 360-16 (15th edition).
- For round tube, $A_v = A / 2$

Member Shear Stresses

Since shear stress is not equally distributed over a cross section, it is unconservative to take the maximum shear stress as simply the beam shear (V) divided by the beam's cross sectional area. To achieve more accurate

$$\alpha_{\text{stress}} := \frac{\tau_{\text{avg}}}{\tau_{\text{max}}}$$

results you must reduce the shear area by a shear stress factor,

where:

$$\tau_{\max} := \frac{V \cdot Q}{I \cdot t}$$

and

$$\tau_{\text{avg}} := \frac{V}{\text{Area}}$$

These shear stress factors will be automatically calculated for all standard members, but must be entered for arbitrary sections. While these shear area coefficients are always less than 1.0, they can vary significantly. Common values include 0.67 for solid rectangular shapes, and 0.75 for solid circular shapes.

Note

- For wide flange and channel shapes, RISA will replace this calculation with the shear stress calculations required by the Steel Code specifications.

Members - Results

When the model is solved, the results are separated into material specific design results and generic results. The generic member results are discussed in this section. The material specific design results are discussed in the following sections of the manual: [Hot Rolled Steel - Design](#), [Concrete - Design](#), [Cold Formed Steel - Design](#), and [Wood - Design](#). For information on **Member Detail Reports** see the [Results](#) section.

Number of Reported Sections

Note that the member results (forces, stresses, code checks) are only reported at the section locations. For example, if you set the **Number Of Sections** in the **Model Settings Dialog** to be '2', you will not get any results for the middle of your member, you will only get results for the end points. If you have a point load applied to your member at a location that is not a section location, you will probably not report the maximum moment in the section if it does not occur at an endpoint.

To Adjust the Number of Sections

- In the **Model Settings Dialog**, select the **Solution** tab.
- Adjust the **Number of Sections** as needed.

Note

- Adjusting the number of sections affects the amount of output.

Number of Internal Sections

Internally, the program subdivides the member into equally spaced sections to calculate forces, stresses, code checks, etc. The **Internal Sections** can be adjusted in the **Model Settings Dialog**. If this value were set to 100, this would mean that for a member that is 100ft long, RISA-2D will calculate these values at approximately every foot. These values are then used in the member steel, wood, and concrete code checks, the diagrams in the model view, and in the detail reports. The locations of the maximum code checks are reported at a distance from the I-joint.

To Adjust the Number of Internal Sections

- In the **Model Settings Dialog**, select the **Solution** tab.
- Adjust the **INTERNAL Sections** as needed.

All other results are reported at the **Number of Sections** that you specify in the **Model Settings Dialog**. This controls how many places you receive **reported** or **printed** member force, stress, torsion, and deflection results. These locations are also equally spaced so setting the value to 5 will give you 5 equally spaced sections; at the ends, the middle and the quarter points.

Note

- Adjusting the number of **Internal Sections** will not affect the amount of output in the results spreadsheets.
- You may want to stick with odd numbers for the **Number of Sections**. Setting the **Number of Sections** to an even number will not report forces/stresses at the midpoint of the member, which is often the location of maximum moment.
- Setting the **Number of Sections** to '2' will only report end forces which, might be desirable for connection calculation but not when looking for maximum forces along a members length. There is a printing option for end forces that is the equivalent to setting the **Number of Sections** to '2' but allows you to see more results on screen while printing only the end forces.

Member Force Results

Access the **Member Section Forces** Spreadsheet by selecting the **Results** Menu and then selecting **Member Forces** then clicking the **Sections** tab **Members** ▶ **Forces**.

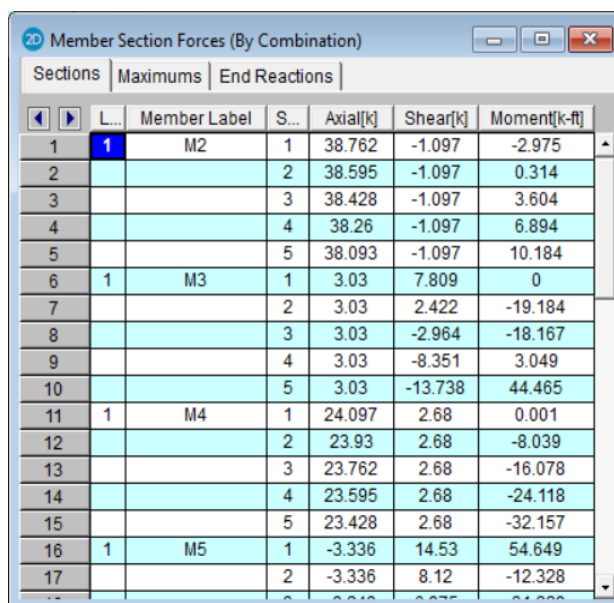

20 Member Section Forces (By Combination)						
Sections Maximums End Reactions						
	L...	Member Label	S...	Axial[k]	Shear[k]	Moment[k-ft]
1	1	M2	1	38.762	-1.097	-2.975
2			2	38.595	-1.097	0.314
3			3	38.428	-1.097	3.604
4			4	38.26	-1.097	6.894
5			5	38.093	-1.097	10.184
6	1	M3	1	3.03	7.809	0
7			2	3.03	2.422	-19.184
8			3	3.03	-2.964	-18.167
9			4	3.03	-8.351	3.049
10			5	3.03	-13.738	44.465
11	1	M4	1	24.097	2.68	0.001
12			2	23.93	2.68	-8.039
13			3	23.762	2.68	-16.078
14			4	23.595	2.68	-24.118
15			5	23.428	2.68	-32.157
16	1	M5	1	-3.336	14.53	54.649
17			2	-3.336	8.12	-12.328

These are the member forces calculated along each active member taking into account any member offsets. The number of sections for which forces are reported is controlled by the **Number Of Sections** specified in the **Model Settings Dialog**.

The units for the forces are shown at the top of each column. As for the sign convention, the signs of these results correspond to the member's local axes, using the right hand rule. The left side forces at each section location are displayed. There are three force values for each section location.

These are axial, shear and moment. Please see the diagram below:

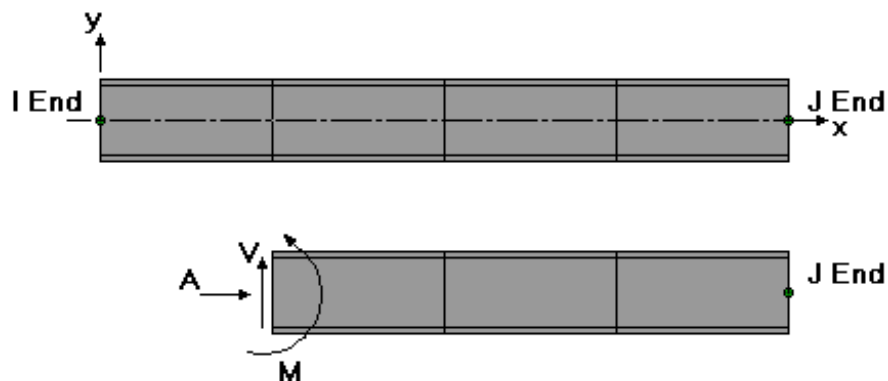

This diagram shows a member section location with all positive section forces. As can be seen, the section forces listed at any given section are the left side forces. For axial forces, compression is positive. For moments, counter-clockwise around the member axis is positive.

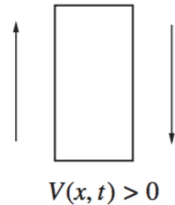

The sign convention for shear is positive when the free body diagram causes the member to spin clockwise (with I End on the left and J End on the right).

These section forces may also be displayed graphically. Remember that the section forces used for the plot are the left side forces. For an example of what you would see for the graphic plot of the moment diagram for a member, please see below:

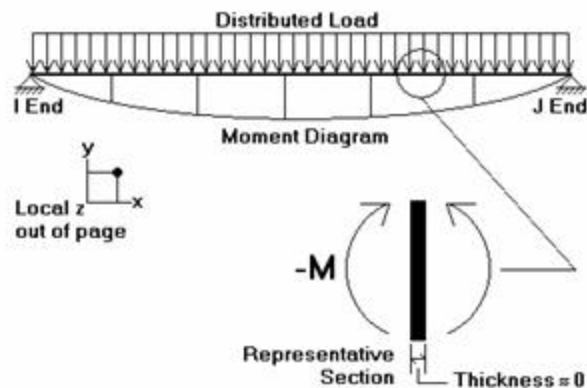

RISA-2D uses the right hand rule **joint convention** and is always consistent with this convention. Since the left side moment is being used, a member under negative M_z moment would have the "holds water" deflected shape, which is contrary to some **beam conventions**. The opposite is true for M_y moments which will tend to "hold water" under a positive moment and "shed water" under a negative moment.

The **2nd/1st Moment Ratios Tab** shows the ratio of maximum moment with and without secondary P-Delta effect. In general, the larger the ratio is, the more significant the secondary effect is. Notice that some design codes may have a limit on this ratio (e.g., ACI has this limit as 1.4), but this limit is not checked by the program.

For enveloped results, the maximum and minimum value at each location is listed. The load combination producing the maximum or minimum is also listed, in the "LC" column.

The moving load results are enveloped and will display the Load Combinations with maximum and minimum values shown for each section location, for each active member. The governing load combination and step location is shown for each result value under the "LC" column. The first number is the load combination, the second is the step number: (load combination - step number). See [Moving Loads](#) to learn more.

Note

- See [Spreadsheet Operations](#) to learn how to use **Find**, **Sort**, and other options.
- See [Model Display Options - MembersModel Display Options - Beams](#) to learn how to plot member results.

Member Stress Results

Access the **Member Stresses Spreadsheet** by selecting the **Results Menu** and then selecting **Members ▶ Stresses**.

	L...	Member Label	S...	Axial[ksi]	Shear[...]	Top Be...	Bot Be...
1	1	M2	1	3.313	-0.312	0.692	-0.692
2			2	3.299	-0.312	-0.073	0.073
3			3	3.284	-0.312	-0.838	0.838
4			4	3.27	-0.312	-1.603	1.603
5			5	3.256	-0.312	-2.369	2.369
6	1	M3	1	0.396	2.783	0	0
7			2	0.396	0.863	6.884	-6.884
8			3	0.396	-1.056	6.519	-6.519
9			4	0.396	-2.976	-1.094	1.094
10			5	0.396	-4.896	-15.955	15.955
11	1	M4	1	2.06	0.763	0	0
12			2	2.045	0.763	1.87	-1.87
13			3	2.031	0.763	3.739	-3.739
14			4	2.017	0.763	5.609	-5.609
15			5	2.002	0.763	7.479	-7.479
16	1	M5	1	-0.17	2.257	-5.602	5.602
17			2	-0.17	1.261	1.264	-1.264

These are the member stresses calculated along each active member. The number of sections for which stresses are reported is controlled by the **Number Of Sections** specified in the **Model Settings Dialog**.

There will be four stress values listed for each section location along the member taking into account any member offsets. The units for the stresses are shown at the top of each column. As for the sign convention, the signs of these results correspond to the signs of the forces. These line up as positive or negative according to the member local axis directions. Compression is positive and tension is negative.

The axial stress is the ratio P/A , where P is the section axial force. A positive stress is compressive, since the sign of the stress follows the sign of the force.

The shear stress is calculated as V/A_s , where A_s is the effective shear area. The program obtains A_s by multiplying the total area by the shear stress factor. This factor is calculated automatically for most cross sections, but must be entered for Arbitrary members. Refer to [Member Shear Stresses](#).

The bending stresses are calculated using the familiar equation $M * c / I$, where " M " is the bending moment, " c " is the distance from the neutral axis to the extreme fiber, and " I " is the moment of inertia. RISA-2D calculates and lists the stress for the section's extreme edge with respect to the positive and negative directions of the local z axis. A positive stress is compressive and a negative stress is tensile.

Note that two stress values are listed for each bending axis. This is because the stress values for a bending axis will not be the same if the shape isn't symmetric for bending about the axis, as with Tee and Channel shapes.

The locations for the calculated stresses are illustrated in this diagram:

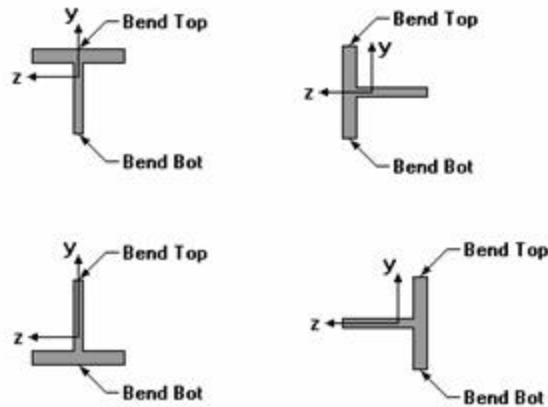

For enveloped results, the maximum and minimum value at each location is listed. The load combination producing the maximum or minimum is also listed, in the "LC" column.

The moving load results are enveloped and will display the Load Combinations with maximum and minimum values shown for each section location, for each active member. The governing load combination and step location is shown for each result value under the "LC" column. The first number is the load combination, the second is the step number: (load combination - step number). See [Moving Loads](#) to learn more.

Note

- A special case is bending stress calculations for single angles. The bending stresses for single angles are reported for bending about the principal axes.
- See [Spreadsheet Operations](#) to learn how to use **Find**, **Sort**, and other options.
- See [Model Display Options - Members](#) to learn how to plot member results.

Single Angle Results

Depending on whether a single angle has been fully restrained against rotation or not, it will either behave about its geometric axes or its principal axes. This behavior can be controlled by correctly specifying the [unbraced lengths](#) for the angle. In the diagram below the z and y axes are the geometric axes. The z' and y' are the principal axes. The y' axis is considered to be the weak axis for principal behavior, and the z' is considered to be the strong axis.

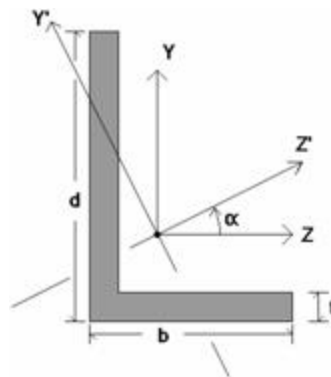

The orientation of the shape is defined using the local y and z axes shown in the above diagram, but for principal axis behavior the bending calculations are done with respect to the y' and z' axes shown (the principal axes). The y' axis is the axis of minimum 'I' and the z' axis is the axis of maximum 'I'. RISA calculates the angle "α" and transposes the moments as shown below:

$$Mz' = Mz * \cos(\alpha) + My * \sin(\alpha)$$

$$My' = -Mz * \sin(\alpha) + My * \cos(\alpha)$$

If the **Rotate** is set to "0" or "180" the M_z' moment is shown as M on the section forces report. Likewise the bend-top and the bend-bot stresses are relative to the extreme fibers along the y' axis. If the **Rotate** code is set to "90" or "270" the M_y' moment is the moment shown as M on the section forces report. The bend-top and the bend-bot stresses are relative to the extreme fibers along the z' axis.

Note

- If both LcompTop and LcompBot have been set to zero then the angle will behave about its geometric axes and the member forces and stresses will be displayed relative to the geometric axes. Alternatively, setting the L-torque value to zero will also constrain the single angle to behave about its geometric axes.

Member Deflection Results

Access the **Member Section Deflections** Spreadsheet by selecting the **Results Menu** and then selecting **Members** ▶ **Deflections**.

	L...	Member Label	S...	x [in]	y [in]	(n) L/y ...
1	1	M2	1	-0.091	-0.002	NC
2			2	-0.097	0.002	NC
3			3	-0.102	0.006	NC
4			4	-0.107	0.001	NC
5			5	-0.112	-0.018	8668
6	1	M3	1	0.021	-0.089	NC
7			2	0.021	-0.198	1736
8			3	0.02	-0.218	1533
9			4	0.019	-0.153	3866
10			5	0.018	-0.112	NC
11	1	M4	1	-0.008	-0.005	NC
12			2	-0.011	-0.053	3281
13			3	-0.014	-0.084	2050
14			4	-0.017	-0.08	2343
15			5	-0.02	-0.023	NC
16	1	M5	1	0.018	-0.112	NC
17			2	0.019	-0.256	2152

The **Service** and **Strength** tabs are the member deflections calculated along each active member. The number of sections for which deflections are reported is controlled by the **Number Of Sections** specified on the **Model Settings Dialog**.

The member section deflections are comprised of translations in the member local axis directions and the relative deflection to length ratio. The units for the deflections are shown at the top of each column. As for the sign convention, the signs of these results correspond to the member's local axes, using the right hand rule.

The L/y' ratio is the total member length (minus member offsets) divided by the relative deflection. The deflection in this calculation is not the deflection shown in the column to the left, which is the absolute deflection. The deflection used is relative to the straight line between the deflected positions of the end joints. For cantilevers, the deflection is relative to the original position of the member.

Expressed as an equation, $n = L/\text{deflection}$, where **n** is what is tabulated in the spreadsheet. The smaller the deflection, the larger the value. If 'NC' is listed, that means the 'n' value is greater than 10000 which is a very small deflection. The minimum value that will be shown is '1'. For example, if the deflection criteria is $L/360$, check here to make sure no tabulated values are **less than** 360. Greater than 360 is OK.

For enveloped results the maximum and minimum value at each location is listed. The load combination producing the maximum or minimum is also listed, in the "LC" column.

The moving load results are enveloped and will display the Load Combinations with maximum and minimum values shown for each section location, for each active member. The governing load combination and step location is shown for each result value under the "LC" column. The first number is the load combination, the second is the step number: (load combination - step number). See [Moving Loads](#) to learn more.

Note

- For members that have not been designated as a beam, the maximum member deflection ratio from the **Service** or **Strength** tab will be reported as the Max Defl Ratio at the end of the [member detail report](#).
- See [Spreadsheet Operations](#) to learn how to use **Find**, **Sort**, and other options.
- If you wish, you can go to the model view to plot and animate the deflected structure. The amount of deflection shown on the plot is controlled by the magnification factor. The joints are plotted based on the joint displacements, and these member deflections are used to plot the member's curvature between the joints. See [Model Display Options – Members](#) to learn how to plot member results.

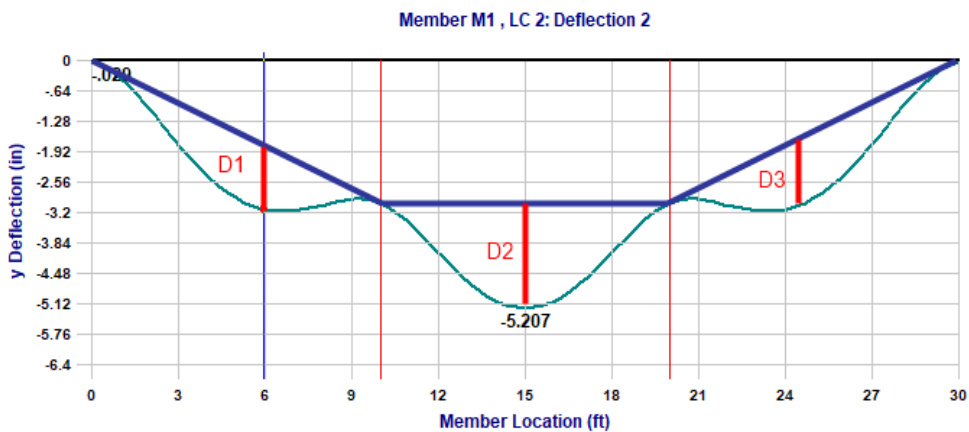

Model Merge

Model Merge is a feature located on the **Tools Menu** that scans through your model and automatically merges elements in the model. Model Merge detects unconnected joints along member spans, unconnected crossing members and duplicate joints, members and plates. You can use Model Merge to build models faster as well as to detect and fix modeling errors.

Knowing what Model Merge does allows you to skip modeling steps as you build your model and let the software perform these steps for you. You can take advantage of Model Merge in modeling your structure in many ways, a few of which are:

Note

- Model Merge will "connect" Physical Members by inserting a joint at their intersection but will not break them up into smaller members. Model Merge also eliminates duplicate Physical Members so you should still use model merge to detect errors when working with these types of members. See [Physical Members](#) to learn more.

Model Merge Options

There are three main options for the model merge.

The [Merge Tolerance](#) is set in the Model Settings screen and defines the maximum distance 2 joints can be apart and still be merged together. It is also used when scanning for crossing members and for unattached joints along the spans of members.

If the **Merge Crossing Members** box is checked then as part of the merge process, all members will be scanned along their lengths for crossing members. Crossing members will be merged together at their intersection points. If you have cross bracing you may or may not want them to be merged. A finite element crossing a physical member will cause only the finite element to be broken up at the point of intersection. If two physical members are crossing, a joint will be placed at the intersection point.

If the **Merge Selected Items Only** box is checked then only the selected part of the model will take part in the merging process.

Merge Inactive Members if left unchecked allows you to limit the merge process to the parts of your model that are selected. This allows you to prevent the program from merging portions of your model where you may have intentionally put joints at the same location or have two members next to each other.

Trim/Extend Crossing Beams can help connect member ends that are within the merge tolerance from an adjacent beam. Checking this box will move the end node of that member so that it lies on the adjacent beam.

Trim/Extend Crossing Wall Panels can help when you have two wall panels that are overlapping or intersecting by a distance smaller than the merge tolerance. This allows you to easily correct minor modeling flaws. This will also correct the condition where a defined wall panel is non-coplanar.

Model Merge Examples

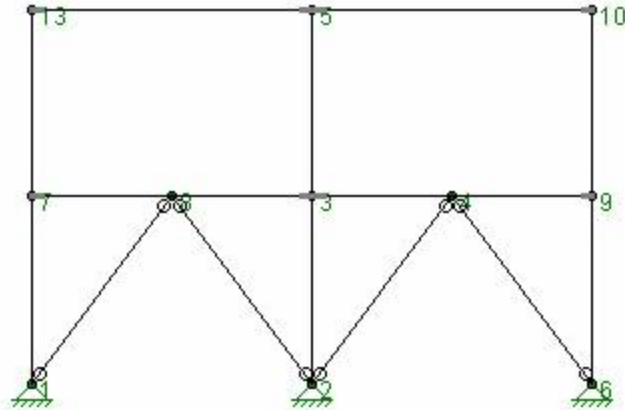

Looking at this frame, consider the column line on the right side, members 1-7 and 7-13. If you did not use Physical Members you would define this just that way, as two separate members. With the model merge capability you could instead enter a single member definition, 1-13, and let the model merge function break it up for you.

Other convenient uses of the model merge function are laying out floor plans and being able to draw all the joints right over the main girders or defining truss chords as full length rather than specifying each panel point. The model merge will take care of breaking up the members at all the intersecting points. Of course the Physical Member feature goes a step farther for these situations because these members **never** need to be split to model a connection – allowing you to make edits and understand results more readily. See [Physical Members](#) to learn more.

Model Merge Limitations

Certain types of shape types and certain load types can cause members to not get broken up by the model merge function. In particular, members that are Tapered WF shapes will not get broken up by the model merge. Even if such members have intermediate unattached joints, or crossing members within their spans, they will not be broken up.

Model Merge Process

1. Duplicate joints are merged together.
2. All the members are scanned for other members crossing along their span. If a crossing member is found, a joints is created at the intersection point.
3. All the members are scanned for joints along their span. If found, the member is broken up into pieces to incorporate the joints.
4. Duplicate members are merged together. Physical members take precedence over finite element members. Longer members take precedence over shorter members that are fully coincident with the longer member. When duplicate members with different section sets are merged, the set listed first in the Sections Sets spreadsheet are used.
5. Duplicate plates are merged together.

To better understand how the model merge function works, please refer to this figure:

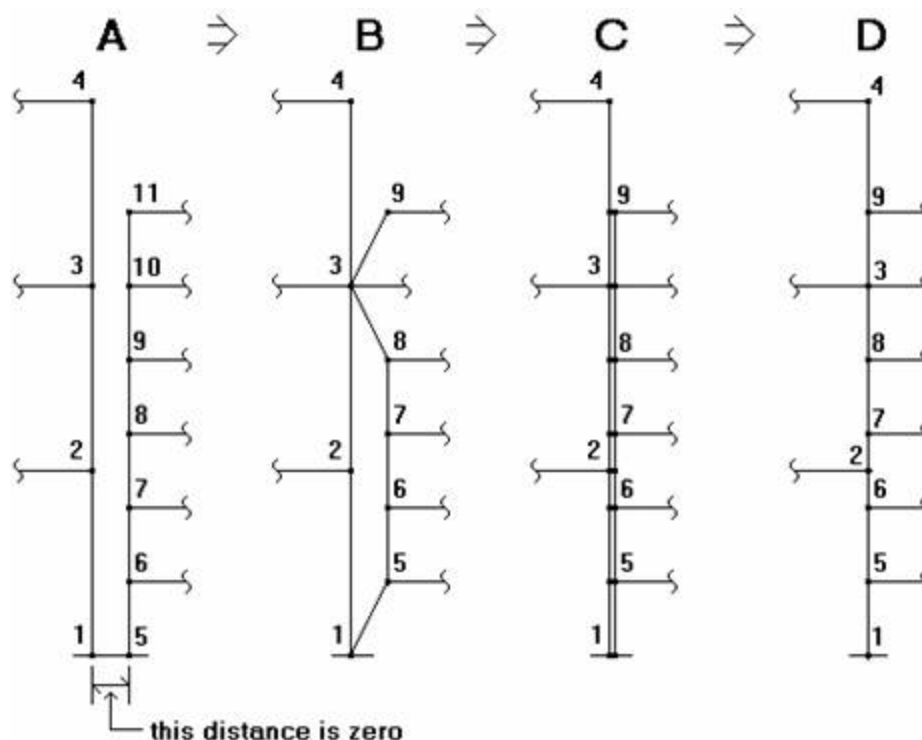

Diagram A shows the model before a merge. The two column lines are separated in diagrams A and B strictly for ease of viewing, they should be considered to be right on top of each other. Joints 1 and 5 (in diagram A) have exactly the same coordinates, as do joints 3 and 10. None of these members are Physical Members.

Step 1 of the merge eliminates duplicate joints changing the model from diagram A to diagram B. On diagram A, joints 1 and 5 are duplicates (same coordinates), as are joints 3 and 10. Joints 5 and 10 are merged into joints 1 and 3 respectively. This means any loads applied to joints 5 and 10 are now applied to joints 1 and 3. Any members connected to 5 and 10 are now connected to joints 1 and 3 (these members are shown with the inclined lines in diagram B).

Step 2 looks for crossing members, however, there aren't any for this particular example. Members that are parallel to each other aren't treated as "crossing" since the end joints of overlapping members will be merged in Step 3.

Step 3 is where the members are scanned for intermediate span joints. This takes us from diagram B to diagram C. Referring to diagram B, member 1-2 has two intermediate joints (5 and 6), member 6-7 has one intermediate joint (joint 2), and so on. The members with intermediate joints are broken up, shown in diagram C.





Step 4 eliminates duplicate members, in this case those that were created in step 2. This takes us from diagram C to diagram D. Looking at diagram C, the duplicate members are shown as the double lines. The first member listed on the **Member** spreadsheet is maintained and the other member is deleted. Any loads applied to the deleted member are transferred to the remaining member.

The final merged model is shown in diagram D. The column line is now comprised of 8 members, 1-5, 5-6, 6-2, etc. up to member 9-4.

Note

- The direction code of loads merged for duplicate members and plates is kept the same. Elements with loads in local directions and different orientations may result in a load direction that is not be the same as the original direction.

To Perform a Model Merge

1. If there is not a model view already open then click  on the **RISA Toolbar** to open a new view and click  to turn on the **Drawing Toolbar** if it is not already displayed.
2. Select the items you wish to merge. Typically you will want everything to be selected.
3. Click the **Merge**  button and set the parameters for the new merge. For help on an item, click  and then click the item.

Note

- You may undo any mistakes by clicking the **Undo**  button.

Modeling Tips

Applying In-Plane Moment to Plates

Occasionally you may need to model an applied in-plane moment at a joint connected to plate elements. The plate/shell element cannot directly model in-plane rotations. One way around this is to model the in-plane moment as a force couple of in-plane forces. You would replace the applied in-plane joint moment at 1 joint with 2 or 4 in-plane forces at 2 or 4 joints, which would produce the same magnitude in-plane moment. See below:

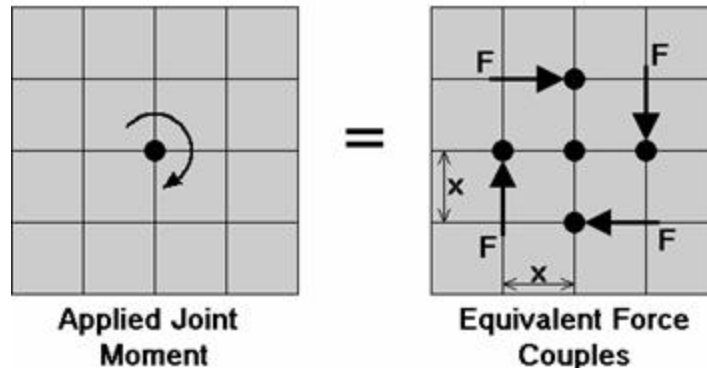

This might require re-meshing the area receiving the moment into smaller plates so that the load area can be more accurately modeled. If a beam member is attached to the joint and will be used to transfer the moment, then you will want to look at the topic **Modeling a Beam Fixed to a Shear Wall** below.

Modeling a Beam Fixed to a Shear Wall

Occasionally you may need to model the situation where you have a beam element that is fixed into a shear wall. A situation where this may occur would be a concrete beam that was cast integrally with the shear wall or a steel beam that was cast into the shear wall. The beam cannot just be attached to the joint at the wall because the plate/shell element does not model in-plane rotational stiffness. A fairly simple work around is to use rigid links to transfer the bending moment from the joint at the wall as shear force to the surrounding joints in the wall. See [Rigid Links](#) in the Modeling Tips section to learn how to create rigid links. This modeling method provides a more accurate analysis than trying to use a plate/shell element with a "drilling degree of freedom" which attempts to directly model the in-plane rotation. See the figure below:

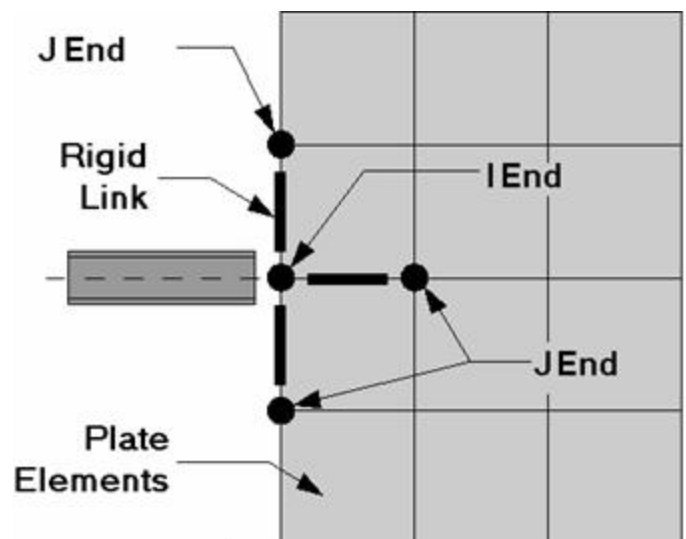

The only trick to this method is getting the proper member end releases for the rigid links. We want to transfer shear forces from the wall joint to the interior wall joints without having the rigid links affect the stiffness of the shear wall. Notice from the figure that the I-joint for all the links is the joint connected to the beam element, while the J-joints are the ends that extend into the shear wall. The J-ends of all the rigid links should have their **x**, **Mx**, **My**, and **Mz** degrees of freedom released. Only the **y** and **z** degrees of freedom (local axes shears) should be connected from the J-ends to the interior wall joints. This release configuration will allow the shears to be transferred into the wall, but the wall stiffness will not be adversely affected by the presence of the rigid links.

Modeling a Cable

While there is not a true “cable element”, there is a tension only element. A true cable element will include the effects of axial pre-stress as well as large deflection theory, such that the flexural stiffness of the cable will be a function of the axial force in the cable. In other words, for a true cable element the axial force will be applied to the deflected shape of the cable instead of being applied to the initial (undeflected) shape. If you try to model a cable element by just using members with very weak **I_{yy}** and **I_{zz}** properties and then applying a transverse load, you will not get cable action. What will happen is that the beam elements will deflect enormously with NO increase in axial force. This is because the change in geometry due to the transverse loading will occur after all the loads are applied, so none of the load will be converted into an axial force.

Guyed Structure (“Straight” Cables)

You can easily model cables that are straight and effectively experience only axial loading. If the cable is not straight or experiences force other than axial force then see the next section.

When modeling guyed structures you can model the cables with a weightless material so that the transverse cable member deflections are not reported. If you do this you should place all of the cable self-weight elsewhere on the structure as a point load. If you do not do this then the cable deflections (other than the axial deflection) will be reported as very large since it is cable action that keeps a guyed cable straight. If you are interested in the deflection of the cable the calculation is a function of the length and the force and you would have to calculate this by hand.

The section set for the cable should be modeled as a tension only member so that the cable is not allowed to take compression. See [T/C Members](#) for more on this.

To prestress the cable you can apply a thermal load to create the pre-tension of the cable. See [Prestressing with Thermal Loads](#) to learn how to do this.

Sagging Cables (Large Deflections) & Transverse Loads **CM note: we are conditioning out this topic because it is impossible to achieve and Christine confirmed that we should not claim to do this type of design in RISA-3D. 8/9/2018**

One way, (although not an easy one) to model a sagging cable is as follows: First you would define members with the correct area and material properties of the cable. You should use a value of 1.0 for the **I_{yy}**, **I_{zz}**, and **J** shape properties. Next you will want to set the coordinates for your joints at a trial deflected shape for the cable. Usually you can use just one member in between concentrated joint loads. If you are trying to model the effects of cable self-weight, you will need to use at least 7 joints to obtain reasonable results. See the figure below for an example of a cable with 5 concentrated loads:

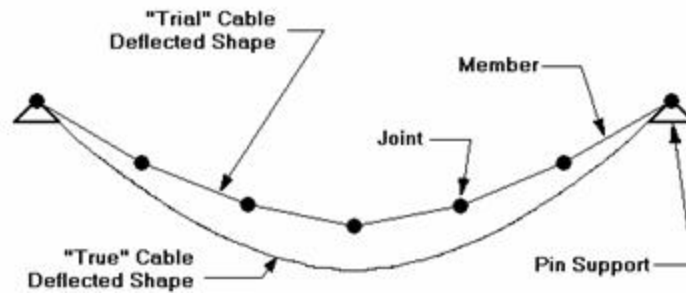

You will want to set the vertical location of each joint at the approximate location of the “final” deflected shape position. Next you will connect your members to your joints and then assign your boundary conditions. Do NOT use member end releases on your members. Make sure you do NOT use point loads, all concentrated loads should be applied as joint loads. You can model pre-stress in the cable by applying an equivalent thermal load to cause shortening of the cable.

Now you will solve the model with a P-Delta Analysis, and take note of the new vertical deflected locations of the joints. If the new location is more than a few percent from the original guess, you should move the joint to the midpoint of the trial and new location. You will need to do this for all your joints. You will repeat this procedure until the joints end up very close to the original position. If you are getting a lot of “stretch” in the cable (more than a few percent), you may not be able to accurately model the cable.

Once you are close to converging, a quick way to change all the middle joint coordinates is to use the Block Math operation. That way you shift many joints up or down by a small amount in one step.

Modeling Inclined Supports

You may model inclined supports by using a short rigid link to span between a joint which is restrained in the global directions and the item to receive the inclined support. See the figure below:

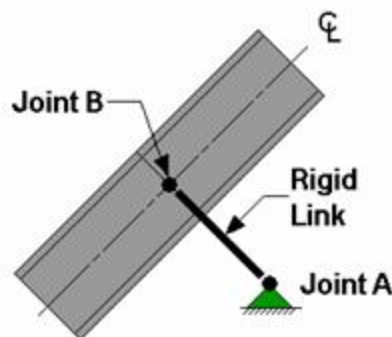

The rigid link should be “short”, say no more than 0.1 ft. The member end releases for the rigid link at joint “B” are used to control which degrees of freedom are pinned or fixed in the inclined directions. This works because the member end releases are in the local member axes. See [Rigid Links](#) in the Modeling Tips section to learn how to create rigid links.

The section forces in the rigid link are the inclined reactions. Note that you need to make sure the rigid link is connected to the members/plates at the correct inclined angle. You can control the incline of the angle using the coordinates of joints “A” and “B”. You can also rotate the rigid link to the proper angle.

Reactions at Joints with Enforced Displacements

The reaction at an enforced displacement can be obtained by inserting a very short (.02' or so) rigid link between the joint with the enforced displacement and any attached members. The member forces in this rigid

link will be the reactions at the joint with the enforced displacement. It is helpful to align the link to be parallel with one of the global axes, that way the local member forces will be parallel to the global directions unless of course you are modeling inclined supports. See Rigid Links below to learn how to create rigid links.

Rigid Links

Rigid links are used to rigidly transfer the forces from one point to another and to also account for any secondary moments that may occur due to moving the force. This is in contrast to using the tether feature for joints where the forces are shared by 2 joint degrees of freedom (DOF), but any secondary moments are lost when tethering the joints. Tethered joints actually share common DOF and so do not account for the distances between them. Rigid links do not have any practical internal deformation, i.e. there is no differential movement between the I-joint and the J-joint. Rigid links may be used to model situations such as composite behavior or beams fixed to walls modeled with plate elements. They are also useful for getting information such as reactions at inclined supports or reactions at joints with enforced displacements.

To Make a Rigid Link

1. On the **General** tab of the **Materials** spreadsheet create a material **Label** called "LINK". Enter "1e6 (ksi)" for the value of **E**. Blank out the value for **G** by going to that field and pressing the space bar. Double check that the **Density** is set to zero. Leave all the other values as their defaults.
2. On the **General** tab of the **Section Sets** spreadsheet create a section set **Label** called "RIGID" with the "LINK" **Material**.
3. Move the cursor to the **Shape** field and hit your space bar to erase the information in this field.
4. Set the **A**, and **I_y**, **I_z** and **J** values to "1e6 (based on units of inches)".
5. To make a rigid link, on the **Member** spreadsheet create a member that references the RIGID section set created above. You can control which DOF are transferred through the link by using the member end releases.

Note

- The density is set to zero in case the self-weight is used in a loading condition. If the density is left as the default then any gravity loading would cause the rigid link to add a very large load into your model due to its large area.
- To keep the model merge from deleting your rigid links, be careful not to create links whose lengths are less than your merge tolerance.

The weight density should be set to zero in case self-weight is used as a loading condition. If the material used is not weightless, then any gravity loading would cause the rigid link to add a very large load into your model. (Gravity load is applied as a distributed load with a magnitude equal to the member area times the weight density).

For models with very stiff elements, like concrete shear walls, the rigid link may not be rigid in comparison. If you see that the rigid link is deforming, then you may have to increase the stiffness of the link. The easiest way to do this is to increase the A, I_y, I_z, and J values for the RIGID section set. Make sure that the combination of **E*I** or **E*A** does not exceed 1e17 because 1e20 and 8.33e18 are the internal stiffnesses of the translational and rotational Reaction boundary conditions. If you make a member too stiff, you may get ghost reactions, which tend to pull load out of the model. (The total reactions will no longer add up to the applied loads.)

Modeling a "Gap" (Expansion Joint) Between Structures

A gap element is a member that mimics the behavior of a gap or expansion joint between adjacent structures.

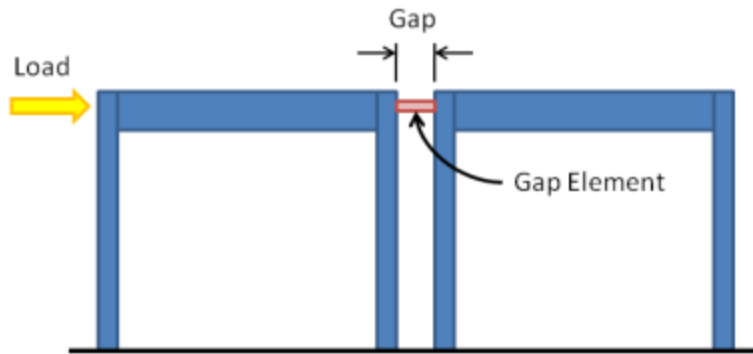

While RISA does not offer the capability to directly create a gap element, one may be indirectly created using the properties of the member and an applied thermal load. The concept is to place a 'shrunk' member between adjacent structures. The shrinkage of the member is achieved with a negative thermal load, in the form of a member distributed load.

The amount of shrinkage should be equal to the width of the gap, such that the structures act independently until they move close enough to each other to 'touch' and thereby transmit loads to each other. To calculate the thermal load required for a gap use the following formula:

$$\Delta T = \frac{-1 * (Gap)}{L * (\alpha)}$$

Where:

ΔT = Applied thermal load

Gap = Distance between two structures

L = Length of gap element

α = Coefficient of thermal expansion

In order to prevent the gap element from 'pulling' its connected structures towards it due to shrinkage it must be defined as a 'compression only' member under the advanced options tab. It is also advisable to define the gap element as a rigid material such that the amount of load it transfers once the gap is closed is not affected by elastic shortening.

Lastly, in cases where the applied temperature would need to be of an extraordinary magnitude, it might be useful to increase the coefficient of thermal expansion of the material such that a smaller temperature load would achieve the same shrinkage.

P-Delta - Analysis

When a model is loaded, it deflects. The deflections in the members of the model may induce secondary moments due to the fact that the ends of the member may no longer be co-linear in the deflected position. These secondary effects, for members (not plates), can be accurately approximated through the use of P-Delta analysis. This type of analysis is called "P-Delta" because the magnitude of the secondary moment is equal to "P", the axial force in the member, times "Delta", the distance one end of the member is offset from the other end.

Since RISAFloor is designing entirely for gravity loads it does not need to account for the P-Delta effect. However, elements of the lateral force resisting system do need to consider this effect when being designed for lateral forces.

For additional advice on this topic, please see the RISA Tips & Tricks webpage at risa.com/post/support. Type in Search keywords: **P-Delta**.

To Perform a P-Delta Analysis

- In **Model Settings -Solution** tab, click the **Advanced** button to choose one of the two methods for P-Delta Analysis, namely the Standard Nodal Shear Method and the Geometric Nonlinear Stiffness Method.
- On the **Load Combination** spreadsheet, indicate the P-Delta combinations by placing a "Y" in the **P-Delta** column.

Note

- You may indicate a compression only P-Delta analysis by placing a "C" in the **P-Delta** column.

P-Delta Procedure

Standard Nodal Shear Method

The actual modeling of these secondary moments is done through the calculation of secondary shears (shown as V in the diagram):

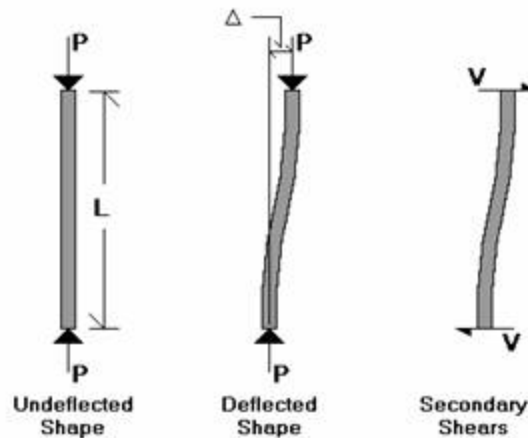

$$P * \Delta = V * L$$

$$\text{so, } V = P * \Delta / L$$

These shear forces are applied at the member ends.

1. The solution sequence is as follows:
2. Solve the model with original applied loads
3. Calculate the shears (V 's) for every member in the model
4. Add these the shears (V 's) to the original loads and re-solve
5. Compare the displacements for this new solution to those obtained from the previous solution. If they fall within the convergence tolerance the solution has converged. If not, return to step 2 and repeat.

Geometric Nonlinear Stiffness Method

Unlike the Standard Nodal Shear method, the Geometric Nonlinear Stiffness Method does not apply any nodal shear load to the member, instead, the stiffness matrix of the structure is directly modified to consider reduction of stiffness due to axial loads. This method is based on approach by Chen, W. F. and Lui, E. M., *Structural Stability: Theory and Implementation* (1987).

Similar as the Standard Nodal Shear Method, this method also requires an iterative procedure. In Step one, the linear static equilibrium equations are solved for the original model. In step two, the internal axial loads obtained from step one are used to form the geometric stiffness matrices as shown below, where P is axial load and L is the member length. The geometric stiffness matrix includes both the P-Delta and P-Small Delta effects. The geometric stiffness matrix is then assembled with the original stiffness matrix to obtain an updated stiffness matrix which considers P-Delta effect. The equilibrium equations are re-solved to obtain the new internal forces/new geometric stiffness matrices, and this procedure is repeated until it converges.

$$[K_g] = P \begin{bmatrix} 0 & 0 & 0 & 0 & 0 & 0 \\ & 6/5L & 1/10 & 0 & -6/5L & 1/10 \\ & & 2L/15 & 0 & -1/10 & -L/30 \\ & \text{sym.} & & 0 & 0 & 0 \\ & & & & 6/5L & -1/10 \\ & & & & & 2L/15 \end{bmatrix}$$

P-Delta Divergence

For both methods, if the P-Delta process is diverging dramatically, it will be stopped before numerical problems develop and an error will be displayed. If this error is displayed, the P-Delta displacements have reached a level where they are more than 1000 times greater than the maximum original displacements. If this happens with your model, the model may be unstable under the given loads, or there may be local instabilities present. See [P-Delta Troubleshooting](#) and [Testing Instabilities](#) to learn how to solve these problems.

For additional advice on this topic, please see the RISA Tips & Tricks webpage at risa.com/post/support. Type in Search keywords: **P-Delta**.

P-Delta Limitations on Standard Nodal Shear Method

The P-Delta algorithm in the Standard Nodal Shear Method is based on end-joint displacements and will not automatically account for the effect of interior span forces on members, or member end rotations. As such the RISA implementation of P-Delta can be referred to as a P-Big Delta analysis.

In addition to the P-Big Delta effect, there can also be a P-Little Delta effect caused by end node rotation or transverse loading between node points. Please refer to the [P-Little Delta](#) topic for more information.

Note

- P-Small Delta effect is considered in Geometric Nonlinear Stiffness Method.
- P-Delta effects are not calculated for plates.
- P-Delta effects are not currently include in Dynamic / Modal Analysis.

Compression Only P-Delta

The P-Delta effect can be thought of as decreasing the flexural stiffness of members in compression and increasing the flexural stiffness of members in tension. It is possible that if you have members with extremely large tensile forces, and intermediate nodes that are not connected to supports or other "stiff" members, the P-Delta algorithm could cause a node displacement to reverse direction, instead of converging to zero. This is an incorrect result. (A practical example where this could happen would be a truss chord with a large amount of tension that also has extra nodes in-between the panel points.) If you have members with very large tensile forces, and intermediate nodes, you may want to do a "compression only" P-Delta analysis. You invoke this by putting a "C" in the **P-Delta** field, instead of a "Y". A "compression only" P-Delta analysis will only affect members that are in axial compression. The P-Delta analysis will not modify members that are in tension.

P-Delta Convergence

The default convergence tolerance is 0.5%. This means that the displacements from one solution to the next must vary by no more than ½ of 1 percent for the solution to be considered converged. You may adjust this tolerance on the **Model Settings**. If you have a model that does converge but takes a lot of iterations, you may want to increase this tolerance so convergence is faster. Be careful! If you set this value too high, unstable models may falsely converge. It is not advisable to set this value above 2 or 3 percent.

P-Delta Troubleshooting

The first step in troubleshooting a P-Delta model that won't converge is to run the load combination without P-Delta analysis and make sure there are no instabilities. If it turns out that degrees of freedom are being locked, this indicates instabilities that you will want to fix.

In some ways, a P-Delta divergence may indicate an elastic buckling failure. Therefore, any P-Delta instabilities should be taken seriously and investigated thoroughly.

Local Instabilities

By far, the most common cause of P-Delta convergence problems is *local* instabilities. A local instability is when one part of the model is unstable causing the P-Delta analysis to diverge. To locate local instabilities, run the solution with P-Delta analysis turned OFF. Now plot the exaggerated deflected shape and animate it. Any local instabilities should be apparent. See [Testing Instabilities](#) for more information.

Flexible Structures

In some cases, a model may be so flexible that it is not possible to run a P-Delta analysis. A situation where this might occur would be a wood frame where all the connections were modeled as pins, but the boundary conditions did not provide positive lateral support. In the real world, the connections will take some moment and the structure would be fine, but in the idealized model, there is zero moment resistance at each connection. The total lateral stiffness would be very small and this would make convergence of a P-Delta analysis unlikely.

Stiffness Reduction for the Direct Analysis Method

The Direct Analysis method requires a reduction in the axial and flexural stiffness of some members. This is done to account for the non-linear material effects caused by residual stresses. This [stiffness reduction](#) can be problematic during the early stages of design when your members may be smaller than they will be after basic drift and stress criteria are met. Therefore, RISA gives you the option (on the [Codes](#) tab of the Model Settings) to turn off this stiffness reduction or set it to a constant value ($\tau = 1.0$).

P-Delta Amplification for AISC ASD

In order to ensure that using LRFD load factors does not result in a penalizing effect for P-Delta analysis, the AISC specification requires that the forces be multiplied by 1.6 during ASD analysis. Therefore, if AISC (360-05, 360-10, or 360-16) ASD is specified as the hot rolled code, RISA automatically multiplies all load combinations by 1.6 during solution, then divides the force results by 1.6 prior to displaying the results.

P-Delta for ACI Concrete

See the [P-Little-Delta Topic](#).

Wall Panels

The P-Delta effect is handled the same way for Wall Panels. The main difference is that the shears for a wall panel are only generated at the top, story, or the diaphragm locations. The average deflection at the story height (or diaphragm location) is used to calculate the P-Delta shears for the top and bottom of the story. These shears are then distributed over the width of the wall at those locations.

Note

- P-Delta effect is NOT considered for wall panels if Geometric Nonlinear Stiffness Method is selected.

Leaning Column Effect

Gravity columns and walls that are modeled in RISAFloor, but which are NOT included in the Lateral analysis will still have an effect on the P-Delta analysis in RISA-3D. This is because RISA-3D automatically includes this leaning column / leaning wall effect. This is done only for columns or walls that are contained within the a rigid diaphragm slab edge at that floor level. The program then uses the RISAFloor column / wall axial loads (without considering LL Reduction) along with the rigid diaphragm displacements (projected to each column / wall) to come up with equivalent leaning column shears for the diaphragm.

Note

- The leaning column effect does not get accounted for columns or walls which do not connect to a diaphragm.
- The leaning column effect does not get accounted for columns or walls that connect to flexible or semi-rigid diaphragms.

P-Little Delta Analysis

The P-Little Delta effect is essentially the destabilizing effect of individual member curvature on the axially loaded members. In practical applications, the effect of P-Little Delta will normally be significantly smaller than the P-Big Delta effect. The following figure demonstrates the displacements that cause the P-Delta and P-Little Delta effect in a typical moment frame.

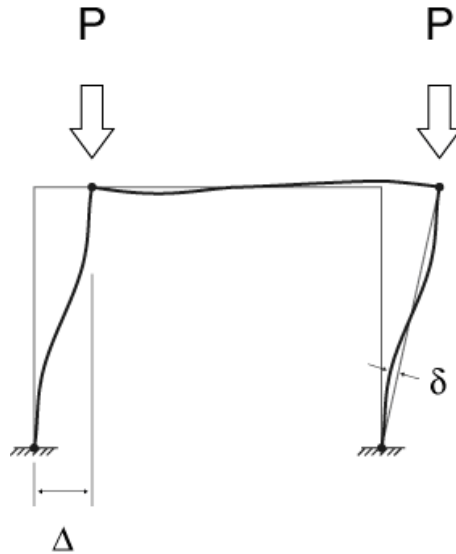

P-Little Delta Procedure

The current implementation of P-Delta analysis does not directly account for the Little Delta effect. While this is true, the model can be easily adjusted to account for the effect as shown in the figure below.

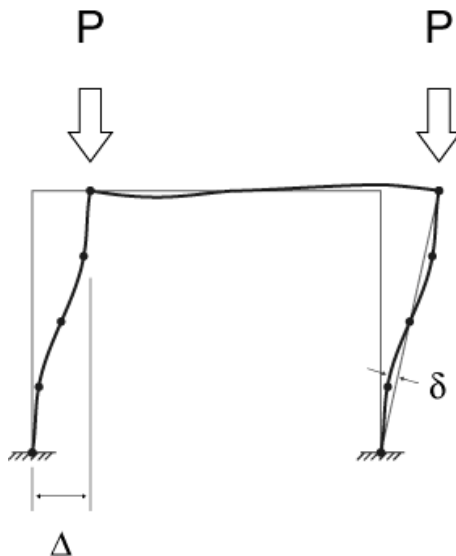

Because RISA's P-Delta method is based entirely on nodal deflections, the introduction of nodes at the locations along the column where member displacement effects are at their maximum will adequately account for this effect.

There are a number of "benchmark" tests given in various publications to determine if a program is capable of properly considering this effect. Some of these benchmark problems (from the AISC Commentary) have been posted to our website with comparisons to theoretically correct solutions. These comparisons can be used as a

basis for when the P-Little Delta effect is significant enough to consider in the analysis. They can also be used to determine how many intermediate nodes are required to adequately account for the effect at a given load level.

Note

- P-Little Delta effects will have more of an impact as a member approaches its elastic euler buckling load. Special attention should be paid to cantilevered compression members, or members with significant weak axis bending moments.

AISC Direct Analysis Method

The AISC manual specifically requires the consideration of the P-Little Delta effect. However, the Direct Analysis Method (AISC 360-16, Chapter C) inherently acknowledges that P-Little Delta may not be important by stating that it may be neglected when, “the axial loads in all members whose flexural stiffnesses are considered to contribute to the lateral stability of the structure” are less than 15% of the Elastic / Euler buckling load of the member.

This may seem like it would be a low axial force, but it can actually be a very large force greater than the total axial capacity of the column. Situations where this code provision may justify ignoring the P-Little Delta effect would include strong axis bending of a wide flange column with equal unbraced lengths in the strong and weak axes.

ACI Concrete Design

As of the 2014 edition, ACI 318 offers three options to account for slenderness and curvature in columns and walls (Section 6.2.6):

- Moment Magnification (6.6.4.5)
- Elastic Second Order Analysis (6.7)
- Nonlinear Second Order Analysis (6.8)

Both forms of second order analysis are more accurate than the moment magnification procedure, which is a hand calculation method intended to be used when computer analysis is not available. RISA does not have a true nonlinear solver though, so the program performs an Elastic Second Order Analysis using cracked section properties.

Columns in RISA-2D

In order to meet the requirements of Section 6.7 (thereby meeting the requirements of Section 6.2.6) you must turn on P-Delta in the [Load Combinations](#) spreadsheet, and possibly add intermediate joints along the length of the columns. The [Split Member](#) tool can be used to add joints along the physical columns.

When ACI 318-08 and newer is used the slenderness effects are *not* neglected per the provisions of Section 10.10.1 (ACI 318-14 Section 6.2.5)

Walls in RISA-2D

In order to meet the requirements of Section 6.7 (thereby meeting the requirements of Section 6.2.6) you must turn on P-Delta in the [Load Combinations](#) spreadsheet and include P-Delta for walls in the [Model Settings](#). The effects of P-Little-Delta are accounted for in walls using the Non-Sway Moment Magnification Procedure of ACI 318-11 Section 10.10.6 or ACI 318-14 Section 6.6.4.5.

Limitations

- The provisions of ACI 318-11 Section 10.10.2.1 (ACI 318-14 Section 6.2.6) which state that P-Delta moments should not exceed 1.4 times non-P-Delta moments are not considered.

Plates/Shells

The plate/shell finite element allows you to easily model shear walls, diaphragms, shells, tanks and many other surface structures. Plate data may be viewed and edited in three ways: graphically, in the **Information** dialog or in the **Plates** spreadsheet. Loads must be applied as joint loads to the joints that define the plates. Loads may also be applied to adjacent beam members. (This would let you apply a distributed load along one edge of a wall, for example.)

Drawing Plates

There are several graphic-editing features that make the creation and modification of models quite easy. Use the Insert and Modify menus or the Drawing Toolbar to use these features in the model view. To create new members or plates, you can draw them using a drawing grid or draw "dot to dot" from existing joints. Once you have created these items you may use other graphic features to load the model and set boundary conditions.

Creating plate models requires more forethought than beam models. See [Plate Modeling Tips](#) and [Plate Modeling Examples](#) for tips on building plate models. To create new plates you can draw them using a drawing grid or draw "dot to dot" from existing joints. You can set all of the plate properties up front or you can modify these properties after you draw them. Modifying properties is discussed in the next sections. See [Plate Spreadsheet](#) for information on plates and their properties.

The **Draw Plates** tool lets you graphically draw plates in your model. Enter the appropriate plate parameters, click **OK** and draw plates between existing joints or on the drawing grid. You will also notice that the coordinates of the joint or grid point that is closest to your cursor are displayed in the lower right hand corner of the model view. The new plates will be shown on screen and will be recorded in the **Plates Spreadsheet**.

To actually draw a plate, you have two options. The fastest way is to use the **Create Plates by Clicking on Grid Areas** option, and then create plates by clicking on the grid areas formed by the intersecting grid lines. As you click on an area, a plate will automatically be created in that area. The second option is to create plates by drawing them one joint at a time. You click on the grid point or joint that you want to be the "A" joint for the plate, then you click on the "B" joint, "C" joint, and then the "D" joint in either clockwise or counter clockwise order. The plate will "stretch" like a rubber band as you draw from joint to joint.

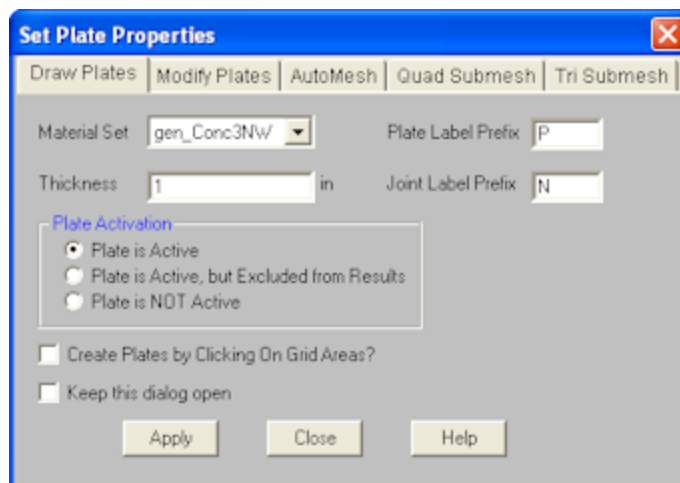

The parameters shown are the same parameters that you would enter on the **Plates Spreadsheet**.

To Draw Plates

1. If there is not a model view already open then click  on the **RISA Toolbar** to open a new view and click  to turn on the **Drawing Toolbar** if it is not already displayed.

2. If you are not drawing between existing joints, you will need to create a drawing grid or define joints on the **Joint Coordinates** spreadsheet.
3. Click the **Draw / Modify Plates**  button and select the **Draw Plates** tab. Then set the plate properties.
 - a. You must click four points in a clockwise or counter-clockwise order. To create a triangular plate click on the third joint twice.
 - b. If in step 3 you chose to click in grid areas then you create plates by clicking between the drawing grids.
4. Click **OK** to start drawing plates by clicking on the joints or grid points with the left mouse button.
5. To stop drawing altogether right click or press the **Esc** key.

Note

- The default plate local axis is Global. To set this to Nodal, see [Solution](#) settings in the **Model Settings**. For more information on plate local axes, see [Plate Local Axes](#).
- To draw more plates with different properties, press CTRL-D to recall the **Plate Properties** settings.
- You may also specify or edit plates in the **Plates Spreadsheet**.
- You may also view and edit plate properties by double-clicking on a plate.
- You may undo any mistakes by clicking the Undo  button.

Modifying Plates

There are a number of ways to modify plates. You may view and edit the member data in the [Plates Spreadsheet](#). You may double-click a plate to view and edit its properties. You can use the Modify Members tool to graphically modify a possibly large selection of members.

The graphical Plate Modify tool discussed here lets you modify the properties of plates that already exist in your model. To use this, you will typically specify the properties you want to change, then select the plates that you want to modify. You can modify plates one at a time by selecting the **Click to Apply** option and then click on the plates you wish to modify. You may also modify entire selections of plates by selecting the plates first and then use the **Apply to Selected** option. See the [Graphic Selection](#) topic for more on selecting.

The parameters shown are the same as those used to define new plates.

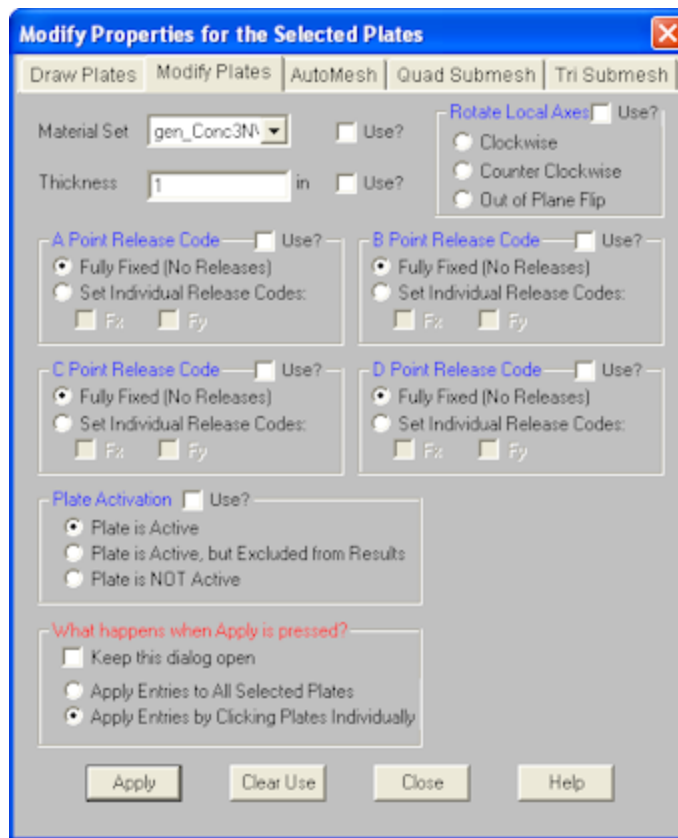





The **Use?** check boxes next to the data fields indicate whether the particular parameter will be used or not when the modification is applied. If the box next to a field is checked, that parameter will be applied to any selected plates. If the box is NOT checked, the parameter will NOT be applied, even if a value is entered in the field. This lets you easily change one or two properties on members without affecting all the rest of the properties. Note that if a no value is entered in a field (I.e. the field is blank) and the corresponding check box is checked, clicking “Apply” will have the effect of clearing the data for these fields.

Rotating Plates

These options allow the user to perform a clockwise, or counter clockwise rotation so that they can better align the plate local axes. It also allows the user to flip the local z-axis so that it is headed in the other direction.

To Modify Plates

1. If there is not a model view already open then click  on the **RISA Toolbar** to open a new view and click  to turn on the **Drawing Toolbar** if it is not already displayed.
2. Click the **Draw / Modify Plates**  button and select the **Modify Plates** tab. Then set the parameters for the new plates. Check the **Use?** Box for the items to apply. For help on an item, click  and then click the item.
3. You may choose to modify a single plate at a time or to an entire selection of plates.
 - a. To modify a few plates choose **Apply Entry by Clicking Items Individually** and click **Apply**. Click on the plates with the left mouse button.
 - b. To modify a selection, choose **Apply Entries to All Selected Items** and click **Apply**.

Note

- To modify more plates with different parameters, press CTRL-D to recall the **Modify Plates** settings.
- You may also modify plates in the **Plates Spreadsheet**.

- You may undo any mistakes by clicking the **Undo**  button.
- It may not be possible to perfectly align the plate local axes.

Submeshing Plates

AutoMesh Plates

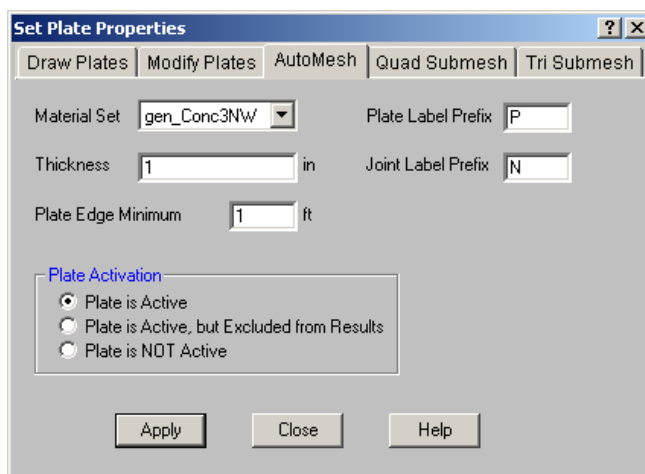

The AutoMesh tool allows you to draw a polygon that RISA-2D will automatically submesh into smaller quadrilateral plate elements. Just as with [Drawing Plates](#), the material set and plate thickness of the plates within the mesh may be indicated prior to drawing the polygon. In addition to these parameters, a plate edge minimum can also be provided. Polygons of virtually any size and shape may be drawn provided the drawing lines do not cross. The polygon points must be on the same plane, either one of the three global planes (XY, XZ, or YZ) or co-planar. Polygons may be drawn in either a clockwise or counter-clockwise direction. To complete a polygon, simply double click on the last joint/grid intersection, or click on the starting joint/grid intersection. Once a polygon is drawn, RISA-2D will create a submesh of quadrilateral plate elements, limited by the edges of the polygon, and of a size corresponding to the plate edge minimum indicated by the user. Note that only quadrilateral plate elements are created with the AutoMesh tool.



When drawing a polygon with the AutoMesh tool, any existing joints within the boundary and in the plane of the polygon will be considered control points. These **Control Points** will be considered "fixed" points within the mesh and will dictate the layout of individual plates surrounding them. It is important to note that only currently selected joints at the time the polygon is drawn will be used as control points.

The AutoMesh tool will attempt to use the Plate Edge Minimum that the user enters. However, if it cannot successfully create a valid mesh, it will automatically re-set the Plate Edge Minimum entry to an edge minimum equal to the minimum distance between two control points.

To AutoMesh a Polygon

1. If there is not a model view already open then click  on the **RISA Toolbar** to open a new view and click  to turn on the **Drawing Toolbar** if it is not already displayed.
2. If you are not drawing between existing joints, you will need to create a drawing grid or define joints on the **Joint Coordinates** spreadsheet.
3. Make sure that all joints that are to be considered **Control Points** are selected.
4. Click the **Draw / Modify Plates**  button and select the **AutoMesh** tab. Then set the plate properties including the plate edge minimum.
5. Click **OK** to start drawing a polygon by clicking on the joints or grid points with the left mouse button.

6. To complete the drawing of a polygon, double click the last point or click on the original starting point.
7. To stop drawing altogether, click the  button, right click or press the **Esc** key.

Note

- To draw more plates with different properties, press CTRL-D to recall the **Plate Properties** settings.
- You may also specify or edit plates in the **Plates Spreadsheet**.
- You may also view and edit plate properties by double-clicking on a plate.
- You may undo any mistakes by clicking the Undo  button.

For additional advice on this topic, please see the RISA Tips & Tricks webpage at risa.com/post/support. Type in Search keywords: **Plate Mesh**.

Quadrilateral Plates

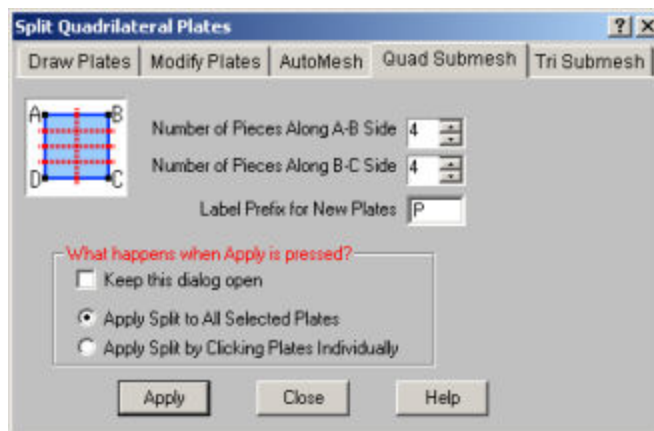

You can submesh quadrilateral (4 sided) plate elements into a mesh of smaller elements. This new mesh can be any size up to the program limits for joints and/or plates. This is very useful for refining a coarse mesh of elements, just make sure that all adjacent plate elements (elements sharing an edge) maintain connectivity.



You can define different submesh increments in each direction. The A,B,C and D joints for each plate are displayed in the plates spreadsheet. The A joint is the first joint clicked on when you created the plate. The B joint is the second and so on. In addition, if the plate local axes is set to Nodal, you can determine which side is which by displaying the plate local axes and realizing that the local x-axis is parallel to the D-C edge of the plate.

You can submesh the plates one at a time by selecting the **Click to Apply** option and then clicking on the plates you wish to submesh. You may also modify entire selections of plates by selecting the plates and then using the **Apply to Selected** option.

To Submesh Quadrilateral Plates

1. If there is not a model view already open then click  on the **RISA Toolbar** to open a new view and click  to turn on the **Drawing Toolbar** if it is not already displayed.
2. Select the plates you want to sub mesh.
3. Click the **Draw / Modify Plates**  button and select the **Submesh Quads** tab. Then specify the number of plates.

Note



- To submesh more plates with different parameters, press CTRL-D to recall the **Submesh Plates** settings.
- You may undo any mistakes by clicking the **Undo**  button.

Triangular Plates

This is used to sub-mesh the selected triangular (3 sided) elements into a mesh of 3 quadrilaterals. This is done by first creating a new joint at the center of each selected triangular element and also at the center point along each edge of the triangular element. These new joints are then used to create three quadrilateral elements that replace the triangular element.



To Submesh Triangular Plates

1. If there is not a model view already open then click  on the **RISA Toolbar** to open a new view and click  to turn on the **Drawing Toolbar** if it is not already displayed.
2. Select the plates you want to sub mesh.
3. Click the **Draw / Modify Plates**  button and select the **Submesh Tris** tab.

Note

- To submesh more plates with different parameters, press CTRL-D to recall the **Submesh Plates** settings.
- You may undo any mistakes by clicking the **Undo**  button.

Plates Spreadsheet - Primary Data

The Plates Spreadsheet records the properties for the plate/shell elements of the model and may be accessed by selecting Plates on the Spreadsheets menu.

Plate Primary Data							
Primary		Advanced					
	Label	A Joint	B Joint	C Joint	D Joint	Material	Thickness[in]
1	P1	N20	N21	N22	N23	gen_Steel	1
2	P2	N24	N20	N23	N25	gen_Steel	1
3	P3	N25	N23	N26	N27	gen_Steel	1
4	P4	N22	N28	N29	N30	gen_Steel	1
5	P5	N23	N22	N30	N26	gen_Conc4NW	8
6	P6	N26	N30	N31	N32	gen_Conc4NW	8
7	P7	N27	N26	N32	N33	gen_Conc4NW	8
8	P8	N33	N32	N34	N35	gen_Conc4NW	8

The following data columns hold the **Primary** data for the plates:

Plate Labels

You may assign a unique label to any or all of the plates. You can then refer to the plate by its label. Each label has to be unique, so if you try to enter the same label more than once you will get an error message. You may relabel plates at any time with the Relabel Plates option on the Tools menu.

Plate Joints

The A, B, C, and D joint entries are used to define the 4 corner joints of a quadrilateral element. (To define a 3-joint triangle element, just leave the D joint entry blank, or make it the same as the C joint.) The joints must all lie on the same plane and be entered in either a clockwise or counter-clockwise sequence.

The direction and sequence in which you define the joints determines how the elements local coordinate system is set up. This is discussed in the section on [Plate Local Axes](#).

Plate Material

The material set label links the plate with the desired material defined on the [Materials Spreadsheet](#).

Note

- Plates are always defined with general materials. This is because the other material sets (Hot Rolled, Cold Formed, Wood, and Concrete) are used to designate member code checking specifications. Since plates are only used for analysis, no code checking is provided and the material must be designated as a general material.

Plate Thickness

The thickness field on the Plates spreadsheet is the thickness of the element. This thickness is constant over the entire element.

Plates Spreadsheet - Advanced Data

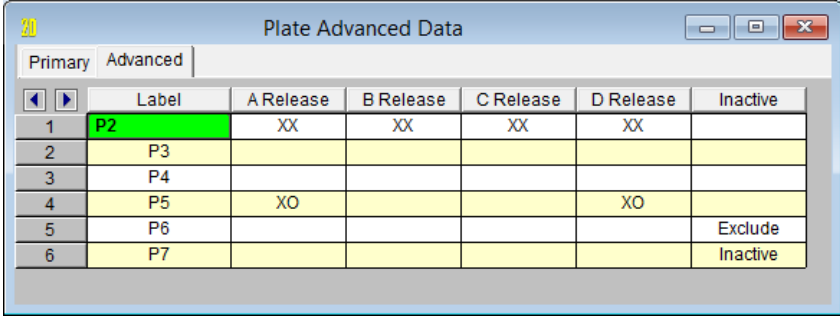

	Label	A Release	B Release	C Release	D Release	Inactive
1	P2	XX	XX	XX	XX	
2	P3					
3	P4					
4	P5	XO			XO	
5	P6					Exclude
6	P7					Inactive

The following data columns hold the **Advanced** data for the plates:

A, B, C, & D Release

The **Plate Corner Releases** for joints A, B, C, and D of each plate may be set in these four data columns. See [Plate Corner Releases](#) for more information.

Inactive

The **Inactive** data column allows for plates to be set to 'Active', 'Inactive', or 'Excluded'. These choices may be made by selecting them from the drop down list or by entering an 'I' for 'Inactive' or an 'E' for 'Excluded'. If the cell is left blank the plate will be 'Active' by default. See [Inactive and Excluded Plates](#) for more information.

Plate Information Dialog

Just as with the joints and members you may double-click any plate to view its properties. All of the same information that is stored in the **Plates Spreadsheet** is displayed for the plate you choose, and may be edited. This is a quick way to view and change plate properties. For large selections of plates however the spreadsheet and graphic editing tools may be the faster solution.

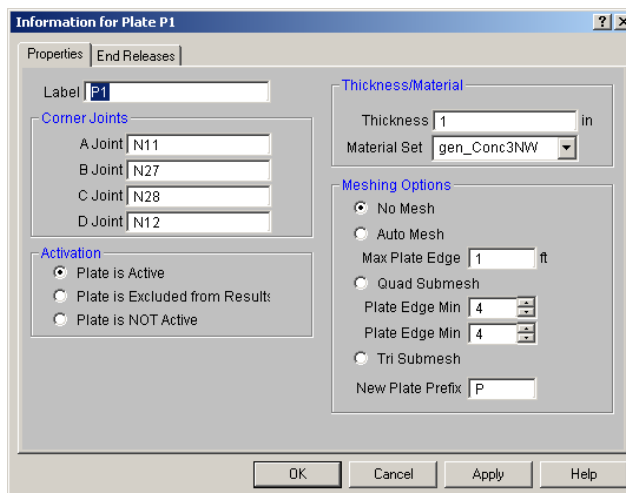

Label - You can view and edit the plate label.

Corner Joints - The corner joint labels are displayed for you to view or edit.

Thickness Material - The plate thickness (in the current dimension units) and the material may be viewed or edited.

Activation - The activation state of the plate may be changed. If the plate is made inactive, you will need to activate the plate from the Plates spreadsheet, or by using the Criteria Select feature to find and select inactive plates.

Meshing Options - The section allows you to mesh the current plate. You may choose between the auto-mesh function or the quad and tri submesh. Refer to the section on [Modifying](#) plates for information on meshing.

Note

- It's generally more efficient to use the Graphic Editing features if you want to change the properties for many plates at once.

Plate Corner Releases

The **A, B, C, & D Release** fields are used to designate whether the forces and moments at the corners of the plate are considered fixed to or released from the plates's points of attachment (the A, B, C, and D joints). Each plate has 2 force components at each corner (Fx, Fy). Either or both of these force components can be released from the plate's point of attachment. If a force component is released, that force is not transferred between the joint and the plate.

To specify plate corner releases go to the **A, B, C, or D Release** fields for the plate on the **Advanced Tab** of the **Plates Spreadsheet**, click the  button, and specify the condition.

Alternatively, you may specify the corner condition by directly typing in the field. To indicate that a force component is released, put a '**X**' for that component in the release field. You can move within the release field using the space bar which will result in a '**O**' for no release.

Note

- It's generally more efficient to use the **Graphic Editing** features if you want to change the properties for many plates at once.

Inactive and Excluded Plates

Making an item such as a member or plate inactive allows you to analyze the structure without the item, without having to delete the information that defines it. This leaves data intact so the item may be easily

reactivated. This is handy if you want to try a model with and then without certain items, without having to actually delete the data.

Putting a "y" in the Inactive field makes the item inactive, i.e. the item is not included when the model is solved or plotted.

Another option is to put an "E". The "E" code means include the item in the solution, but exclude it from the results list. So, an item with an "E" in the "Inactive?" field will be treated like any other plate in the solution and plotting of the model, but the plate will not be listed in the solution results (forces, stresses etc.). This is useful if there are certain items whose results you're not interested in. You don't have to clutter up the results with these items and can concentrate on the items you're most interested in. See [Printing](#) for more limiting printed results.

Plate Local Axes

The A, B, C, and D joints are used to define the corners of a quadrilateral element. (To define a 3-joint element, just leave the D joint blank, or make it the same as the C joint.) The joints must all lie on the same plane and be entered in either a clockwise or counter-clockwise direction.

The direction and sequence in which you define the joints determines how the elements local coordinate system is set up. The plate local axes can be set to Global or Nodal in the [Solution](#) settings in the **Model Settings**. The following images depict the difference between Global and Nodal plate local axes, which are shown graphically in green. To view the plate local axes in such a manner, add the Plate Local Axes button from the available toolbar buttons. For more information, see [Customizable Model View Toolbar](#).

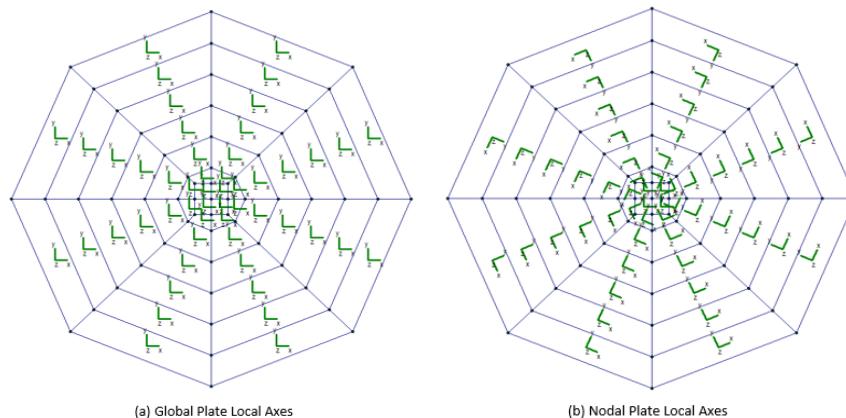

When the plate local axis is set to Global, the local axes of all plates will be oriented in the same orthogonal direction, regardless of plate geometry. However, the positive out-of-plane z-axis will be dependent on the configuration in which the plate or mesh was drawn. The plate local out-of-plane axis will always be the z-axis, but the positive direction of this axis will be dependent on the direction in which you define the joints of the plate. Defining the joints in a clockwise pattern will result in the out-of-plane z-axis pointing in the positive direction according to the global axes. For example, in the global XZ-plane, a plate drawn in the positive clockwise direction will result in the plate local out-of-plane z-axis pointing along the global positive Y-axis. Similarly, a counter-clockwise pattern will result in the out-of-plane z-axis pointing in the negative global axes direction. Plates do not follow the right-hand rule that is common in three-dimensional vector orientation. For more information on the interpretation of plate results based on local axis orientation, see [Plate Force Results](#).

When the plate local axis is set to Nodal, the local x-axis is defined as positive from the D joint towards the C joint for 4 joint elements and from C towards B for 3 joint elements. The local y-axis is then placed as close to pointing towards the A-joint as possible. Note that for triangular elements, the y-axis will probably not pass through the A-joint. For 3 joint elements, the y-axis is "towards" the A-joint and perpendicular to the x-axis. Once the x and y axes are defined, the positive local z-axis is found using the right hand rule.

The following diagrams illustrate how the elements local coordinate system is related to the joint numbering sequence and direction:

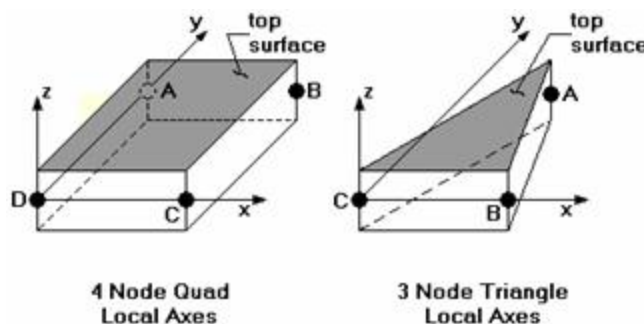

The default plate local axis is set to Global. To change this to Nodal, see [Solution](#) settings in the **Model Settings**.

Plate/Shell Element Formulation

The element used is a mixed interpolation 4 joint quadrilateral element. By mixed interpolation, we mean that the in-plane and transverse shear strain components are derived independently. This allows the element to be easily simplified into a plane stress element in cases where transverse shear and bending are not desired. A reference for this element is Finite Element Procedures, by K.J. Bathe, Prentice-Hall, 1996. The book also provides many references for papers on the elements convergence and other characteristics. In brief, the element can model isotropic behavior for plane stress, plate bending and out-of-plane transverse shear.

This is accomplished by starting with the Mindlin-Reissner plate assumptions and adding interpolating functions for the out-of-plane transverse shear. This approach is analogous to incorporating shear deformation with flexural effects in beam theory. This results in an element that can be used for thin and thick plate applications. Traditional plate elements do not model out-of-plane transverse shear well (if at all) and cannot be used for thick plate applications. The element is also very insensitive to distortion.

Note:

- The linear-elastic behavior of the program implicitly means that non-linear (2nd order) behavior is not generally supported. Tension-structures such as fabric structures would fall into this non-linear category. Please see the [Modeling Tips - Modeling a Cable](#) section for some ways to approximate this behavior. This section is applicable to members but the principles illustrated are also applicable to plate modeling as well.

RISA-2D also provides a 3-joint triangle element that can be used to build transitional meshes. The stress characteristics of the triangle are not as accurate as the 4-joint quad and use of the triangle should be limited. It is not recommended that the stresses from the 3-joint triangle be used at all. In fact, RISA-2D's [AutoMesh](#) tool will only create quadrilateral plate elements for this very reason. RISA-2D provides a way to convert your triangular plates to quadrilaterals, see [Submeshing Triangular Plates](#).

Orthotropic Behavior

The RISA plate element allows a limited degree of Orthotropic material behavior. Specifically, the In-Plane shearing of the plate will be almost entirely controlled by the G value for the material whereas the direct In-Plane compressive stiffness will be controlled by the Evalue of the material.

Plate Modeling Tips

A word of caution is in order if you are new to plate modeling. Unlike modeling with beam elements, plate elements require some understanding of finite element behavior to successfully obtain meaningful results. It is easy to build a finite element model using the powerful generators and graphic editing tools. However, without understanding the limitations of the analysis method used, you can end up with an impressive looking but very

inaccurate model. Even if you've been engaged in structural engineering for years, modeling with plates is not something most engineers do frequently. It is therefore not realistic to have the expectation that you should be able to perform complicated analysis with plate elements in a short amount of time. Good plate modeling takes time, knowledge of plate and finite element behavior, and experience.

The first tip is to read all the Plate documentation before embarking on an ambitious modeling project. This will save you much aggravation down the road.

Plate Distortion

The finite elements in a model should be as undistorted as possible. See the following figure:

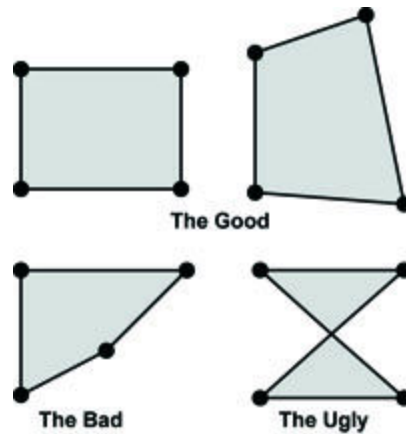

Plate Generation

A fast way to build a new mesh of finite elements is with the generation features. RISA-2D currently provides several generation features to quickly build common structures providing an easy way to create cylinders, cones, grids, radial grids and disks of plates. The best way to see what these features do is to experiment with them. See [Generation](#) to learn more about generation.

Another time-saving method is to draw large elements to represent continuums such as slabs and shear walls and then use the submesh features mentioned below to refine the mesh.

Note:

- Before sub-meshing, make sure that any adjacent "large" elements connect at their corner joints. That way, any subsequent sub-mesh operations will produce element meshes that automatically connect at the intermediate joints.

Automatic Plate Sub-Meshing

What if you've already built a model and you now decide that your finite element mesh is too coarse? To submesh elements see [Submeshing Plates](#). Performing a Model Merge afterwards will insure that all the new elements get connected to existing beam elements and that duplicate joints get merged. See [Model Merge](#) for more information.

Plate Error Checking

The program cannot provide a solution for plates which are poorly shaped or not planar. If any such "degenerate" plates exist, an error is produced during the solution. Use the Degenerate Plate Check utility in the Tools menu to fix these issues.

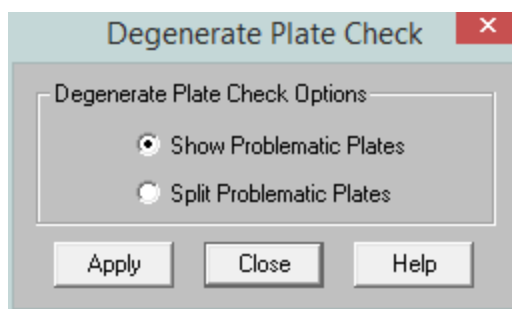

This utility can be used for two purposes:

- **Show Problematic Plates** provides a model view showing all plates that were non-planar or poorly shaped. A summary report lists the number of degenerate plates, and the warning log is populated with an exact list.
- **Split Problematic Plates** splits each non-planar plate into four triangular plates. By definition a triangular plate is always planar, so this will allow the model to solve. The force and stress results for these triangular plates are not accurate, and should not be used for design. However, the stiffness is adequate for force transfer, so this splitting tool provides a convenient method to force a solution in a model where manually fixing the plates to be planar would be too time consuming, and where the plate stresses are not a concern.

Finite Element Basics

While this will not be a comprehensive treatment of plate and finite element fundamentals, a review of certain key basic concepts and terminology will be valuable to the engineer who has not worked with finite elements, or has not had the opportunity to use them recently.

A place to start is with the types of forces or stresses that can occur in a plate. One term that is commonly used is “plane stress”. This term is used to describe a state of stress in a plate where all the stresses occur in the plane of the plate. A real world example would be a shear wall with forces applied only in the plane of the wall. The resulting plate forces would be just the normal stresses (F_x , F_y) and the in-plane shear stresses (F_{xy}). There would be no plate moments or out-of-plane shears generated.

Stress vs. Force

It should be pointed out that the results for a plate are always a stress. These stresses are multiplied by the plate thickness and the width or length to obtain a force. Note that this force obtained is just an average value for the plate, since the stress was for a point on the plate and it undoubtedly will vary throughout the plate area. The fact that the stresses vary within a plate is why a good finite element mesh is so critical to obtain accurate results. Stresses tend to vary more around point loads and supports, and less in regions that are far from supports and have a uniform load.

A different example of plate forces would be a horizontal diaphragm that is loaded only in the out-of-plane direction. The plate results would be plate moments, out-of-plane shears, but no membrane (plane stress) stresses. The reason for no membrane stresses is that there was no in-plane loading.

Sign Convention

One other comment on plate results is to point out the convention used for moments in plates. With beams, the M_y moment describes the moment about the local y -axis. However, with a plate element, the M_y moment is the moment that produces stresses in the local y -direction. The M_y moment in a plate is actually about the local x -axis. For more information, see [Plate Force Results](#).

Why Meshing Is Required

In a nutshell, finite elements tend to work by trying to approximate the correct deflected shape of the real world item being modeled. For example, if we are trying to model a horizontal diaphragm, simply supported on all edges, and loaded out-of-plane, our finite element model must be able to approximately recreate the deflected shape of the diaphragm.

In order to do this with some accuracy, we must use a mesh of elements to represent the physical diaphragm. If we try to model the diaphragm with only one element (which is what everyone tries to do at least once), we will get very inaccurate results because one finite element cannot accurately model the deflected shape of the physical diaphragm. The multiple reasons for this are beyond the scope of this file, and if you want to understand the “why” please study a reference on finite element analysis such as Bathe’s book.

The most important concept to understand is that finite elements require a certain number of free or unrestrained joints in order to produce accurate results. Using enough elements in your mesh will produce accurate results for the deflection and stresses in the structural item being modeled. The gauge of “enough” for common structural elements is addressed in the Plate Model Examples section of the Reference Manual.

Distortion

Finite elements are also affected by geometric distortion. The best shape for the 4-joint quadrilateral is a square. In practice, elements are frequently distorted, which is fine as long as they aren’t squashed too far out of shape. The largest internal angle should never be equal to or greater than 180 degrees, and preferably shouldn’t even approach 180 degrees.

Drilling Degree of Freedom

One last item is that the element used by RISA-2D, like other plate/shell elements, cannot accurately model in-plane rotations. I.e., a plate/shell element will not provide resistance to a moment applied about the plate’s local z-axis. For example, let’s say you have a 4x4 grid of elements, simply supported about the edges, and you apply a joint moment to one of the internal joints so that the moment is about the local z-axis of the elements. RISA-2D will solve such a model, however you will get all zeros for the joint reactions and the element stresses. See [Applying In-Plane Moments to Plates](#) to learn how to work around this limitation.

Plates/Shells - Results

When the model is solved, there are several groups of results spreadsheets specifically for the plates.

Plate Stress Results

Access the **Plate Stresses Spreadsheet** by selecting the **Results Menu** and then selecting **Plates ▶ Stresses**.

	LC	Plate Label	Sigma...	Sigma...	Tau M...	Angle[r...	Von Mi...
1	1	P2	.005	0	.002	.066	.005
2	1	P3	.007	0	.003	0	.007
3	1	P4	.008	0	.004	.017	.008
4	1	P5	.01	0	.005	.012	.01

The principal stresses σ_1 (σ_1) and σ_2 (σ_2) are the maximum and minimum normal stresses on the element at the geometric center of the plate. The Tau Max (τ_{\max}) stress is the maximum shear stress. The Angle entry is the angle between the element's local x-axis, and the direction of the σ_1 stress (in radians). The Von Mises value is calculated using σ_1 and σ_2 , but not σ_3 which isn't available for a surface (plate/shell) element, so this Von Mises stress does not include any transverse shear forces.

The equations are:

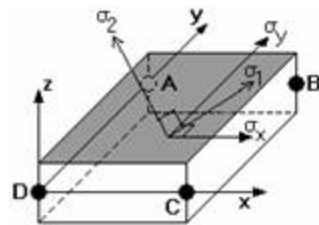

Plate Principal Stresses

$$\sigma_1 = \frac{(\sigma_x + \sigma_y)}{2} + \sqrt{\frac{(\sigma_x - \sigma_y)^2}{4} + \tau_{xy}^2}$$

$$\sigma_2 = \frac{(\sigma_x + \sigma_y)}{2} - \sqrt{\frac{(\sigma_x - \sigma_y)^2}{4} + \tau_{xy}^2}$$

$$\tau_{\max} = \frac{(\sigma_1 - \sigma_2)}{2}, \quad \phi = \frac{1}{2} \arctan \left(\frac{2\tau_{xy}}{(\sigma_x - \sigma_y)} \right)$$

$$\text{Von Mises} = \sqrt{\sigma_1^2 - \sigma_1\sigma_2 + \sigma_2^2}$$

The angle, ϕ , is the angle in radians between the maximum normal stress and the local x-axis. The direction of the maximum shear stress, τ_{\max} is $\pm \pi/4$ radians from the principal stress directions.

The Von Mises stress is a combination of the principal stresses and represents the maximum energy of distortion within the element. This stress can be compared to the tensile yield stress of ductile materials for design purposes. For example, if a steel plate has a tensile yield stress of 36ksi, then a Von Mises stress of 36ksi or higher would indicate yielding of the material at some point in the plate.

For enveloped results the maximum and minimum value at each location is listed. The load combination producing the maximum or minimum is also listed, in the "LC" column.

Note

- See [Spreadsheet Operations](#) to learn how to use **Find**, **Sort** and other options.
- See [Model Display Options - Plates](#) to learn how to plot joint results.

Plate Force Results

Access the **Plate Forces Spreadsheet** by selecting the **Results Menu** and then selecting **Plates ▶ Forces**.

	LC	Plate Label	F _x [k]	F _y [k]	F _{xy} [k]
1	1	P2	.533	.032	.033
2	1	P3	.723	.038	0
3	1	P4	.909	0	.016
4	1	P5	1.084	0	.013
5	1	P6	1.26	.031	.027
6	1	P7	1.445	.142	.079

The **Plate Forces** are listed for each active plate. Interpretation of output results is perhaps the most challenging aspect in using the plate/shell element. The results for the plates are shown for the geometric center of the plate.

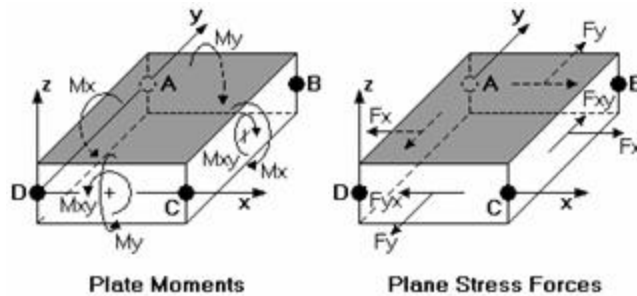

The plane stress forces (F_x , F_y and F_{xy}) are those forces that occur in the plane of the plate. These forces, which are also called “membrane” forces, are constant through the thickness of the element. F_x and F_y are the normal forces that occur respectively in the direction of the local plate x and y-axes, positive values indicating tension. These forces are reported as a force/unit length. To get the total force on an element, you would need to multiply the given value by the length of the element that is perpendicular to the normal force. For example, looking at the 'Plane Stress Forces' figure, the total F_x force could be obtained by multiplying the given F_x force by the length of side BC (the distance from joint B to joint C).

The F_{xy} force is the in-plane shear force that occurs along the side of the element. The subscript 'xy' indicates that the shear occurs on the face of the element that is perpendicular to the x-axis and is pointing in the y-direction. F_{yx} is the complementary shear force, where the subscript 'yx' indicates that the shear occurs on the face of the element that is perpendicular to the y-axis and is pointing in the x-direction. RISA-2D only gives values for F_{xy} because F_{xy} and F_{yx} are numerically equal. The total in-plane shear can be obtained by multiplying the given force value by the length of the element that is parallel to the shear force. For example, when looking at the 'Plane Stress Forces' figure, the total F_{xy} force which is parallel to the local y-axis could be obtained by multiplying the given F_{xy} force by the length of side BC.

Note that the membrane (F_x , F_y , F_{xy}) results are forces per unit length. For example, a rectangular element with a B to C length of 10 feet showing a F_x force of 20K would have a total normal force on the B-C face of the element of 20K (per foot) times 10 feet, or 200K.

For enveloped results the maximum and minimum value is listed. The load combination producing the maximum or minimum is also listed, in the "LC" column.

Note

- See [Spreadsheet Operations](#) to learn how to use **Find**, **Sort** and other options.
- See [Model Display Options – Plates](#) to learn how to plot joint results.

Plate Corner Force Results

Access the **Plate Corner Forces Spreadsheet** by selecting the **Results Menu** and then selecting **Plates ▶ Corner Forces**.

	LC	Plate Label	Joint	X[k]	Y[k]
1	1	P2	N11	.046	-.759
2			N51	-.107	1.181
3			N57	-.007	1.005
4			N56	.069	-.712
5	1	P3	N51	-.072	-1.096
6			N52	0	1.454
7			N58	-.002	1.38
8			N57	.074	-1.024
9	1	P4	N52	.013	-1.376
10			N53	-.015	1.763
11			N59	-.04	1.71
12			N58	.041	-1.384
13	1	P5	N53	.015	-1.673

The plate corner forces are the global forces at the corner of each plate and are listed for each active plate.

These are the forces and moments calculated at the corners of the plates, in the GLOBAL directions. These values are obtained by multiplying the plate's corner displacements with the global stiffness matrix. Unlike the local stresses and forces, which are very accurate approximations, these corner forces represent EXACT results based on linear elastic theory. Also, the local forces are listed on a 'per unit length' basis, whereas these global direction corner forces represent the total force on the plate at the corner in the given direction, in the same way that joint reactions are reported. At any given joint, the corner forces for all plates connected to that joint should sum to zero (a requirement of equilibrium), assuming no members or boundary conditions are also present at the joint.

As an example of how to use these corner forces, you can obtain the total shear at a given level in a shear wall by adding the proper corner forces for the plates at that level. See [Plate Modeling Examples](#) to learn how to use the plate corner forces to get shear wall story shears and moments, as well as slab moments and shears.

For enveloped results the maximum and minimum value is listed. The load combination producing the maximum or minimum is also listed, in the "lc" column.

Note

- See [Spreadsheet Operations](#) to learn how to use **Find, Sort, Label Marked Lines in Current View>Show Selected Lines in Current View** and other options.
- See [Model Display Options – Plates](#) to learn how to plot joint results.

Plates/Shells - Design Tools

Internal Force Summation Tool

This tool may be activated by clicking the  icon below the Selection Toolbar or by using the Right-Click menu from within a model view. The tool is only available from within a model view that has active results for a single combination or a batch solution. This tool is not available for an envelope solution.

The Internal Force Summation Tool can be used to quickly come up with information on story shears in a building, or internal moments in a elevated or on grade slab.

When initiated, the tool requires the user to select two points (A and B). These points will be used to define the plane in which the internal force summation will be performed. That defines a "cutting plane" perpendicular to the screen. A red line will appear to indicate the edge of this plane. As you slide the cutting plane back and forth, the status bar at the bottom of the screen will give a summary of the internal forces for the currently selected items. These forces are reported at the cutting plane location with respect to the local 1,2,3 axes that defined the cutting plane.

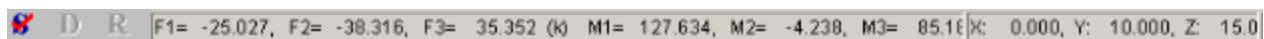
 F1= -25.027, F2= -38.316, F3= 35.352 (k) M1= 127.634, M2= -4.238, M3= 85.11 X: 0.000, Y: 10.000, Z: 15.0

Clicking on a third point will lock the cutting plane to that exact location and provide a detailed summary of the internal forces at that location. These summary results are summarized below:

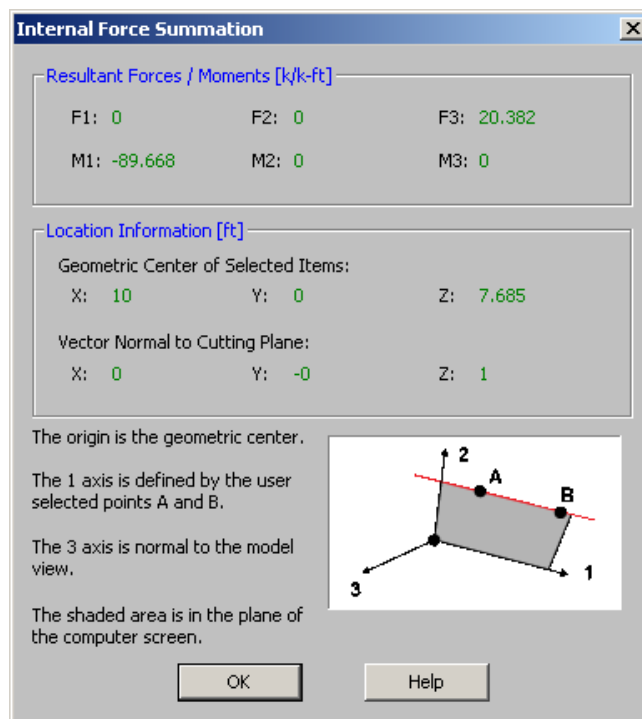



The Internal Force Summation report is separated into three regions. The first region gives the resultant forces and moments. The second region gives information needed to locate the reference plane and origin of local axes. The third region gives a basic reference for the orientation of the local axes and forces.

Since the **Forces** and **Moments** are summed only for the selected members, this tool can be easily used to determine the overall story forces in a shear wall or moment frame (if the whole model is selected), as well as the forces in an individual bent or pier (if only a portion of the model is selected).

The **Geometric Center of the Selected Items** defines the origin at which the forces (F1, F2, and F3) are reported. This also corresponds to the point used to define the moments (M1, M2 and M3). These forces and moment are

all given with respect to the local 1, 2, 3 axes. The local 3 axis is always perpendicular to the current model view. The local 1 axis is always defined parallel to the points A and B which were selected by the user. The 2 axis is then defined by the right hand rule.

Note:

- For wall panel specific internal force summation, press the  button. This button is intended to be used by clicking two points in the same plane as a wall panel (or a group of co-planar wall panels).
- For semi-rigid slab specific internal force summation, press the  button. This button is intended to be used by clicking two points in the same plane as a slab (or a group of co-planar slabs). Semi-rigid slabs are elements found in RISA-3D in a combined RISAFloor-RISA-3D model with slab floors.
- For additional advice on this topic, please see the RISA Tips & Tricks website: www.risa.com/post/support. Type in Search keywords: **Story Shears** or **IFST**.

Calculation and Theory

When cutting through a plate, the internal force summation tool uses the plate corner forces to derive the force in the cutting plane. When cutting through the interior of a plate, any corner node that is "above" the cutting plane is included in the summation. Moments are then interpreted based on the location of the forces compared to the centroid of the cutting plane. See the figure below:

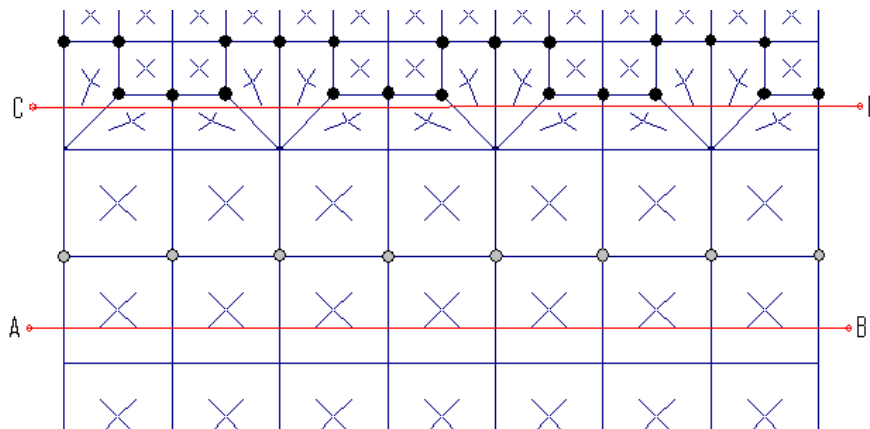

Consider the cutting plane A-B defined above. This was created by clicking from left to right on the page (from A to B). Therefore, there are 8 nodes above cutting plane A-B. These are highlighted in a gray color and are the nodes whose corner forces will be used to create the base value of the cutting plane force. Because the cutting plane is below the row of nodes, and because there may be applied surface or self weight loading at the plates, some interpolation must be used between the values above the plane and the values below the plane. This consists of essentially a linear interpolation.

For cutting plan C-D there are 22 nodes above the cutting plane that will be used to determine the base value of the cutting plane force.

Note

- This tool only computes forces for elements that are selected in your model. In the same sense, it will sum up forces for **everything that is selected** that is in the cutting plane. You may use the selection tools to unselect portions of the model for which you do not want force results for.
- Because these forces are reported with respect to the local 1,2,3 axes of the cutting plane it is NOT recommended that this tool be used from an isometric view of the structure. It will function best in a pure plan or a pure elevation view.

- The results for the internal force summation tool are always given for the currently displayed results. The currently displayed results show up in the Model Display Options selection (the  icon). If the model has not been run and there are no results, then the tool will be unavailable. Similarly, the tool is not available with Envelope Results.

Contour Display Details

This tool may be activated by clicking the  icon below the Selection Toolbar or by using the Right-Click menu from within a model view and selecting **Make a Cut Over Displayed Contour**. The tool is only available from within a model view that is currently plotting a plate contour.

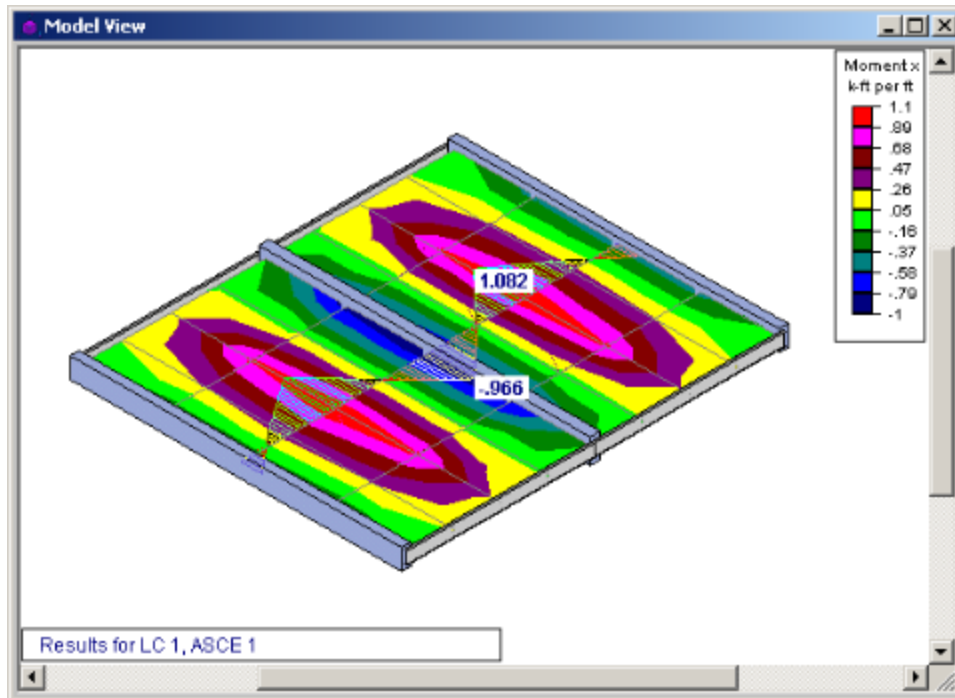

This tool can also be used for curved plate models such as tanks and vessels. The integral of the force diagram is displayed in the Status Bar at the bottom of the screen. This may be useful for summing up shear forces in a wall or lintel.

Total Integral: 5.39501, Positive Integral: 10.1131, Negative Integral: -4.71807 (k-ft)

The Contour Display Detail is used to turn a visual plate contour into a more traditional shear or moment diagram. The tool merely transforms the visual contour display into actual numerical that can be viewed by the user. In the image below, the contour display shows the numerical values associated with the contour at the cutting line.

When a Contour Display Detail is shown, the right click menu gives access to a Detailed Diagram of the contour cut as shown below:

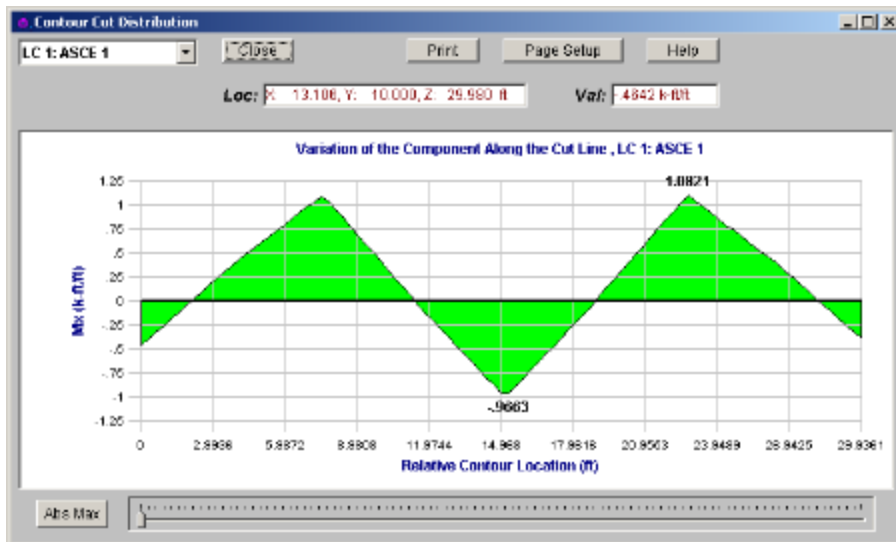

This detailed diagram will show you all the results for every section along the length of the diagram. This information may even be copied to the clipboard for use in a spreadsheet program. This can be done by selecting **Copy Data** from the right click menu.

Note

- Because this display is just a currently displayed plate contours, the units for the detailed diagrams are always the same as for the displayed contours.

Plates/Shells - Modeling Examples

The finite element method is an approximating method. This means that the results will never be exact and can be made better and better, within reason, by sub-dividing the element mesh. Accurate results are dependent on the modeling of the problem.

The following pages are studies of finite element mesh fineness and its relationship to accurate stress and deflection results. These studies are meant to be an aide to help you select appropriate mesh fineness for a structure you are trying to model. These studies will also answer the "why" many people ask when told they must use a "mesh" of elements to model a structural item (such as a shear wall) instead of using one giant element. Obviously these studies only give an overview of some basic elements and the engineer must be the final judge as to whether a specific finite element model is a good reflection of the "real" structure.

Shear Wall Modeling

Theoretical Deflection of Shear Wall with Point Load

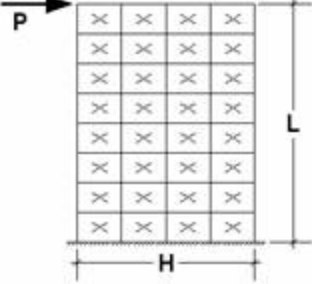
	Shear Wall Properties	$I = BH^3/12$ $= 12(120)^3 / 12$ $= 1,728,000 \text{ in}^4$
	$L = 240 \text{ in}$ Area = 1440 in ² $B = 12 \text{ in}$ $H = 120 \text{ in.}$ $E = 4000 \text{ ksi}$ $\nu = 0.30$ $G = 1538.5 \text{ ksi}$ $P = 15,000 \text{ kip}$	$\Delta = PL^3/3EI + 1.2 PL / AG$ $= 11.95 \text{ in}$ $K = P / \Delta$ $= 15,000\text{k} / 11.95\text{in}$ $= 1255 \text{ kips/in}$

Stiffness as a Function of Mesh Fineness

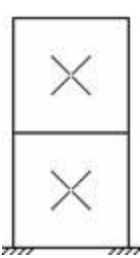
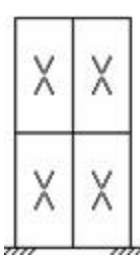
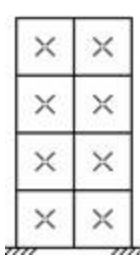
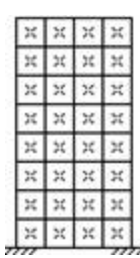
					
Element Mesh	1x1	1x2	2x2	2x4	4x8
Deflection (in.)	4.54	8.07	8.26	10.43	11.29
Error	62%	33%	31%	13%	6%
Stiffness K (kips/in)	3304.0	1858.7	1816.0	1438.2	1328.6

Note on Methodology:

- Since the theoretical solution is based on an assumption that plane sections shall remain plane after deformation, the last model (4x8 mesh) had very stiff axial members included at the 2nd, 4th, 6th and top level across the width of the wall. This prevented horizontal differential joint movement and allows for a more meaningful comparison with the theoretical solution.

Shear Wall Design Forces

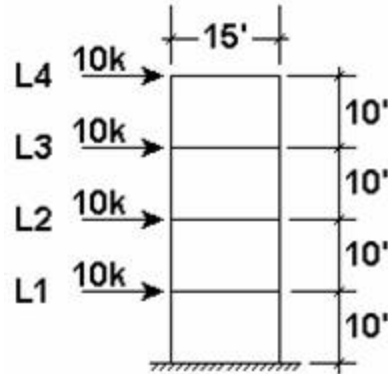

Floor	Shear	Moment	Elements
4	9.99k	100.05k-ft	P49-P52
3	20k	300.08k-ft	P33-P36
2	30k	600k-ft	P17-P20
1	40k	999.98k-ft	P1-P4

Shown above are the analysis results of a 4-story shear wall. This example is for a straight shear wall, however the method and results are valid for box, channel, or any other shear wall shapes.

The RISA-2D files that were used to obtain these results are included as "4X1WALL.R3D" and "4X4WALL.R3D". The 10 kip story loads were applied uniformly across each story. This was done to more accurately model loads being applied to the wall from a rigid or semi-rigid floor.

The story shears at each level were calculated as the sum of the FX corner forces. The story moments at each level are calculated from the FY corner forces as shown below:

$$M_i = (F_{y\text{outer joint}} * 15\text{ft}) + (F_{y\text{inner joint}} * 7.5\text{ft})$$

Story Shears - Hand Calculation

The story shears were calculated as shown below from the corner forces. See the screen shot close up of the FX corner forces on the next page.

Story	Sum FX Corner Forcers at Story Level (k)	Shear	Moment
4	$[0.462 + 0.786 + 1.77 + 1.98] * 2 = 9.996$	9.9k	P49-P52
3	$[1.2 + 1.65 + 3.45 + 3.7] * 2 = 20.000$	20k	P33-P36
2	$[1.9 + 2.5 + 5.14 + 5.46] * 2 = 30.000$	30k	P17-P20
1	$[11.76 - 0.32 + 6.09 + 2.47] * 2 = 40.000$	40k	P1-P4

For the graphical display of the corner forces, there are 4

1.3	0.52	1.2	1.3	20.5	1.2		
P61		P62		P63	P64		
-7	-1.1	1.5	-1.8	1.8	-1.5	-1.1	-7
0.7	0.8	1.8	1.8	1.8	1.8	0.8	0.7
P57		P58		P59		P60	
-7	-8	1.7	-1.8	1.8	-1.7	-8	-7
0.7	0.8	1.8	1.8	1.8	1.8	0.8	0.7
P53		P54		P55		P56	
-6	-8	1.7	-1.9	1.9	-1.7	-8	-6
0.6	0.6	1.9	1.9	1.9	1.9	0.6	0.6
P49		P50		P51		P52	
-5	-8	1.8	-2	2	-1.8	-8	-5
1.7	1.7	3.3	3.2	3.2	3.3	1.7	1.7
P45		P46		P47		P48	
-1.5	-1.9	3.2	-3.4	3.4	-3.2	-1.9	-1.5
1.5	1.7	3.4	3.4	3.4	1.7	1.5	

Level 4 Global FX Corner Forces

corner forces shown for each plate. This is similar to a beam element which has 2 member end forces.

To get the story shear at any line, just sum up all the FX corner forces along the line.

0	1.1	1.1	1.1	1.1	0		
P61		P62		P63	P64		
-1.2	0.2	1.2	1.1	1.1	1.2	-2	1.2
1.2	1.6	1.6	1.4	1.4	0.6	1.6	-1.2
P57		P58		P59		P60	
-2.1	-7	1.7	1.1	1.7	1.7	2.1	2.1
2.1	2.5	1.1	1.6	1.6	0.1	2.5	-2.1
P53		P54		P55		P56	
-3.1	-1.5	2.3	0.7	0.7	2.3	1.5	3.1
3.1	3.3	0.5	2.2	2.2	-5	3.3	-3.1
P49		P50		P51		P52	
-3.9	-2.5	3	0.6	0.6	3.2	5	3.9
3.9	5.2	0.3	3.1	3.1	-3	5.2	-3.9
P45		P46		P47		P48	
-6.2	-2.9	4.6	1.2	1.2	4.6	2.9	6.2
6.2	6.7	0.9	3.5	3.5	-9	6.7	-6.2

Level 4 Global FY Corner Forces

To get the story moment at any line, just sum the moments obtained by multiplying the Fy corner forces along a line, times the moment arm such as the distance of each Fy force to the center of the wall.

Story Shears - Summation Tool

A quicker way to calculate story forces is to use the [Internal Force Summation](#) tool to have the program automatically calculate the global forces that pass through a given elevation of the shear wall. To do this, just

click on the  icon that appears below the selection toolbar whenever you have a set of valid, non-envelope solution results. This tool will sum the forces for the displayed items at the desired elevation and will report them back to the user in terms of the Global X, Y and Z directions.

For additional advice on this topic, please see the RISA Tips & Tricks webpage at risa.com/post/support. Type in Search keywords: **Story Shears**.

Story Moments

The story moments are calculated as the FY Corner forces times their moment arms. The forces are symmetrical so each force on one side is multiplied by twice the arm length.

Story	Sum FY Corner Forces * Moment Arm (k)	Story Moment	Elements
4	$[3.92 \text{ k} * 15' + (2.48 \text{ k} + 3.02 \text{ k}) * 7.5'] = 100.05 \text{ k'}$	100.1 kip-ft	P49-P52

Story	Sum FY Corner Forces * Moment Arm (k)	Story Moment	Elements
3	$[12.33 \text{ k} * 15' + (7.9 \text{ k} + 7.45 \text{ k}) * 7.5'] = 300.075 \text{ k}'$	300.1 kip-ft	P33-P36
2	$[24.93 \text{ k} * 15' + (16.5 \text{ k} + 13.64 \text{ k}) * 7.5'] = 600.00 \text{ k}'$	600 kip-ft	P17-P20
1	$[45.81 \text{ k} * 15' + (25.16 \text{ k} + 16.55 \text{ k}) * 7.5'] = 999.975 \text{ k}'$	999.9 kip-ft	P1-P4

Shear Wall Penetrations

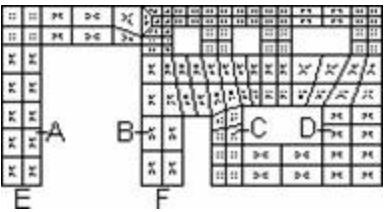
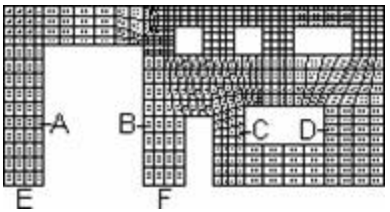
		
Horizontal Deflection at Top	0.028 in.	0.033 in.
Shear @ A-A	10.82 kips	10.53 kips
Shear @ B-B	24.2 kips	23.08 kips
Shear @ C-C	33.74 kips	33.05 kips
Shear @ D-D	45.26 kips	47.35 kips
Reactions at E	10.8 kips	10.53 kips
Reactions at F	24.2 kips	23.06 kips

This is an example of a typical concrete shear wall with penetrations for windows and doors of various sizes. The files for the models are WALLPEN1.R3D (coarse mesh) and WALLPEN2.R3D (fine mesh). No theoretical solution results are given to compare with, however the two finite element densities are compared to observe the rate of convergence to the “true” answer. The shears at the various lines are computed by adding up the X corner forces for the element corners closest to the lines. The horizontal deflection is for the top of the wall. A very rigid link is added to the top of the wall to simulate the effect of a concrete horizontal diaphragm. This has the effect of stiffening the walls and spreading the load uniformly across the top of the wall. The load is applied as a uniform load of 3.0 kips/ft. across the top of the wall. The total width of the wall is 38 ft, so the total applied load is 114 kips. The total height of the wall is 18 ft.

The “coarse” mesh on the left is an example of the minimum finite element mesh that should be used to model this type of wall. Notice that the coarse mesh gives good results for the wall shears and reactions. The overall deflection of the coarse mesh is off by about 15% from the “fine” mesh. The coarse mesh tends to give too much stiffness to the slender walls around the loading door opening on the left, this can be seen in the larger reactions at points E and F as well in the horizontal deflections. The fine mesh on the right shows that the slender wall sections are more flexible than shown by the coarse mesh and thus the reactions and wall shears are reduced for the slender wall sections.

Plate Connectivity Problems

Shown below is a common modeling problem with plate elements. Since plates only have connectivity at their corner nodes, the applied load at middle joint connects to the plates below the joint, but not to the one above it.

Because of this lack of connectivity, you see the joint "pushing through" the plate edge above in the plotted deflected shape.

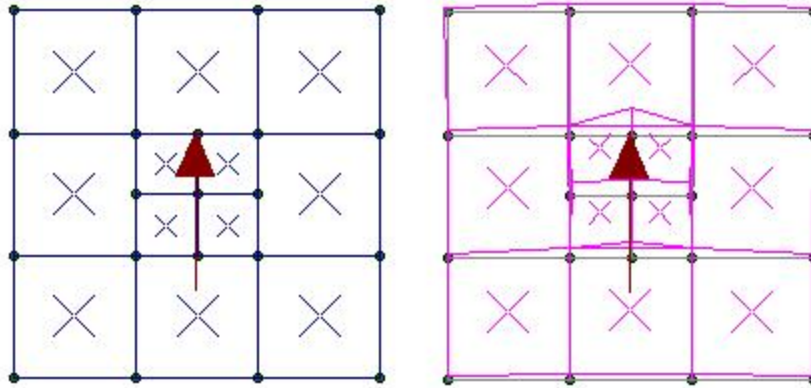

The proper way to handle this type of mesh is with one of the mesh transitions described in the following section.

For additional advice on this topic, please see the RISA Tips & Tricks webpage at risa.com/post/support. Type in Search keywords: **Plate Connectivity**.

Mesh Transition Examples

Coarse Mesh to Fine Mesh

Shown below are two methods for transitioning from an area with a fine mesh to an area with a larger / coarser mesh.

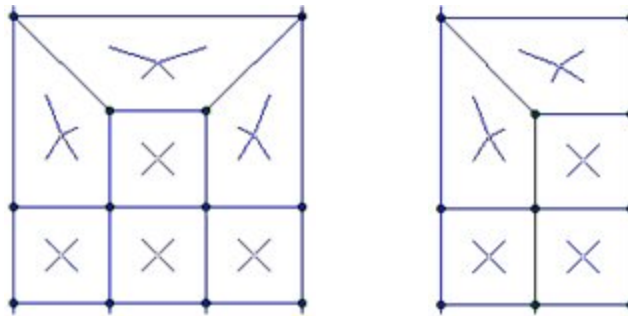

Three to One

Two to One

Rectangular Mesh to Radial Mesh

Shown below are two methods for transitioning from an area with a rectangular mesh into an area with a radial mesh.

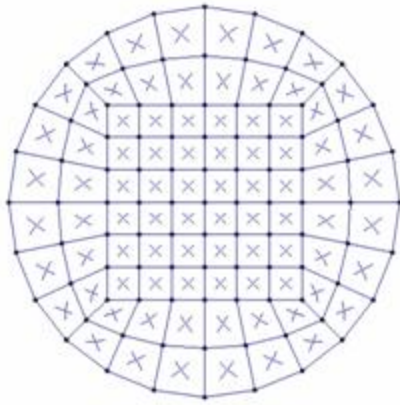

Square to Round

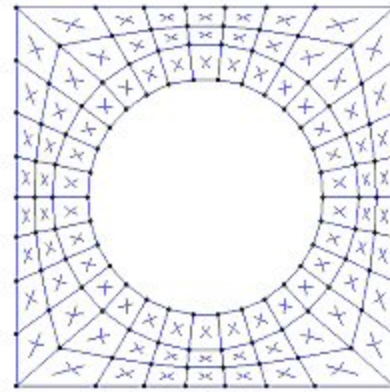

Round to Square

For additional advice on this topic, please see the RISA Tips & Tricks webpage at risa.com/post/support. Type in Search keywords: **Plate Mesh**.

Printing

You may print graphics as they appear on the screen or print all (or part) of the tabulated model information. If a spreadsheet is currently active and you click the print  button the following options are presented. If a model view is currently active, and you select the print button, [Graphic Print Options](#) are presented.

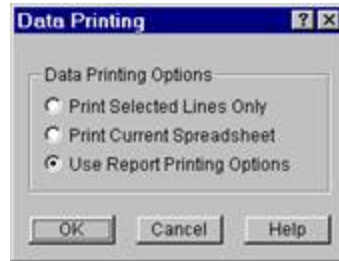

If you have lines selected in the spreadsheet then you may print only those lines by selecting the first option. If you wish to print the entire spreadsheet you may choose the second option. The last option allows you to print multiple spreadsheets in a custom report that is discussed in the next section. You may combine the last two options with the Exclude feature to hide some data and print only the data you want.

To Print a Report or a Spreadsheet

- While in a spreadsheet click on the **Print**  button and choose to print the current spreadsheet, a selected portion of the spreadsheet, or multiple sections by printing a report. If you are in a model view the Graphic Print Options are opened so click 'Print a Report Instead'.

To Print Graphics

- While in a model view click on the **Print**  button and choose from the options.

Note

- If you are not in a model view the Data Printing settings are opened instead. Close this and click on the model view that you want to print before clicking the **Print**  button.

Printing Reports

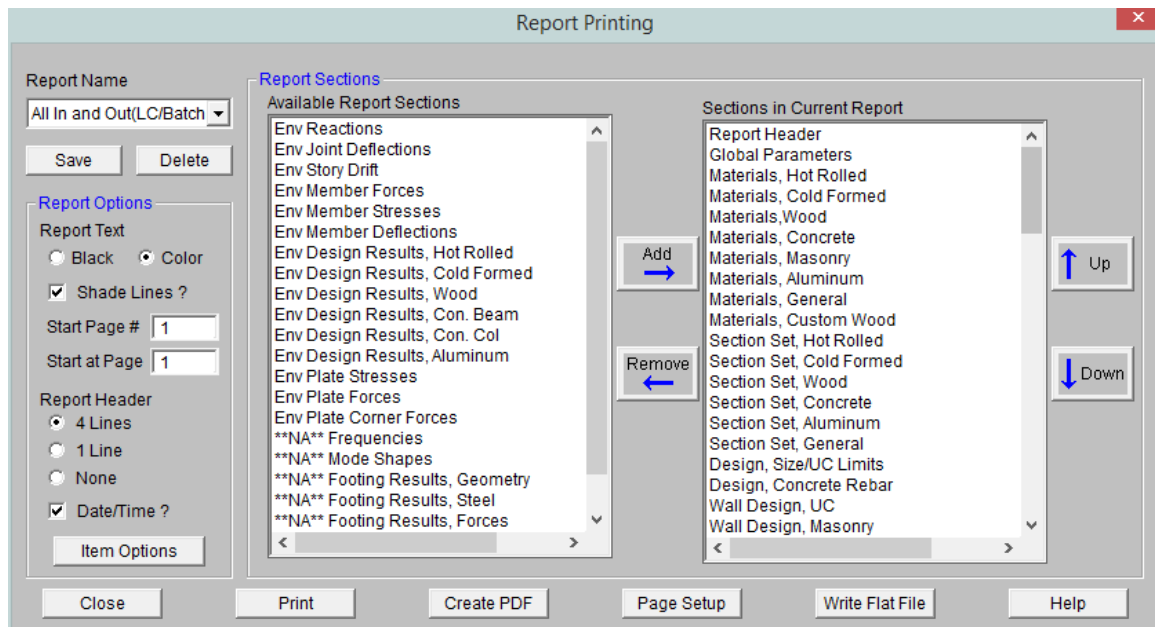

The **Report Printing Dialog** options help you build your reports. There are standard reports for you to choose from and you may also name and save any report format you custom build. To choose a standard report, simply pick it from the **Report Name** drop down list.

Building a Report

To build your own custom report you may double-click on report sections in order to move them from the available sections on the left, to the report defined on the right. You may use the mouse and the SHIFT or CTRL keys to pick multiple sections and then move them with the **Add** button. You can re-order the report by dragging and dropping the sections in your report you would like to move with the **Up** and **Down** buttons and remove sections with the **Remove** button.

The **Sections in Current Report** portion of the dialog shows which sections and the order the printed report will be built. Report sections can come from either the **Available Report Sections** or the **Additional Report Sections**. The **Available Report Sections** contains every input and output spreadsheet in the program. The **Additional Report Sections** contains all images that were added to the project. Images can be added either using the "Snapshot" option or by adding external images using the **Add Images/Documents** button.

Note:

- Any saved reports from the Report Names drop-down will currently only save spreadsheet information. Any snapshots or images will manually need to be added to any saved reports.
- The program will flag solution spreadsheets as to whether there is information available in them. If that type of solution has not been run you will see a prefix of ****NA**** ahead of that spreadsheet in the **Available Report Sections**.

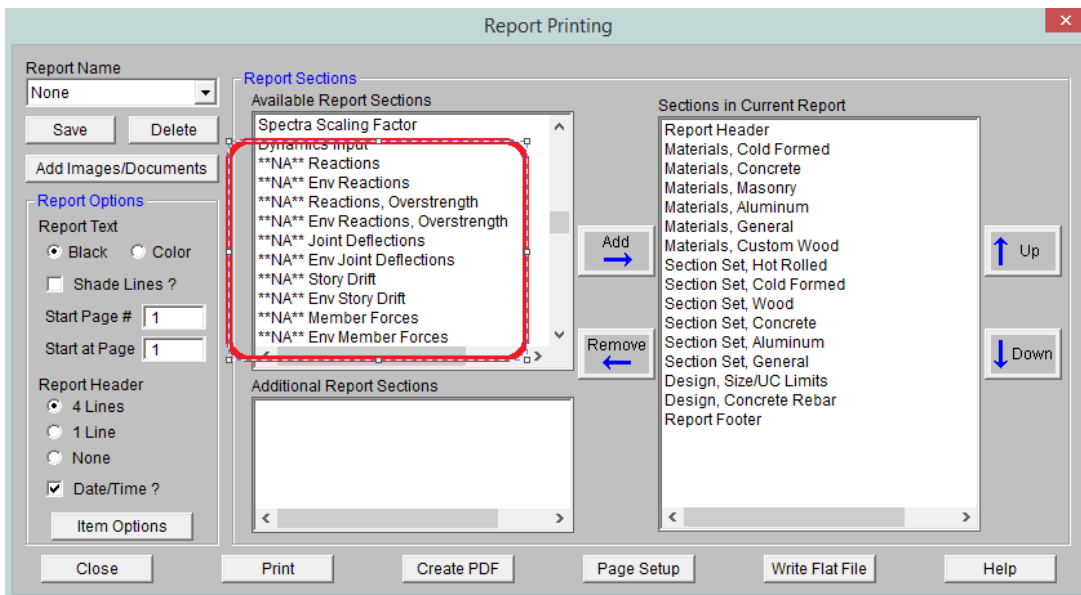

Report Options

Formatting options allow you to specify many options:

Report Text - Allows you to define the text color as black or blue.

Shade Lines? - Allows you to shade every other line to enhance readability.

Start Page # - Allows you select the starting page number. The number shown will be the next page number in the current sequence, but you can override this for occasions where you need to insert your calculation pages into an existing report and you need the page numbering to match.

Start at Page - Allows you to start your numbering at some page other than page one. This can be helpful if you have a title page or table of contents that you don't want to number.

Report Header - All reports have a footer with version information, the file name and path, and the page number. The single line header option will include the Model Title specified in the **Model Settings** along with the date. The triple line header adds company, designer, job number, and a place to initial any checking to the header.

Date/Time? - Allows you to turn off the Date/Time stamp so that this will not appear on your printed reports.

Item Options - Allows you to select member related options. You may specify that you want the member results to be listed for each member section (specified in the **Model Settings**) or just for the member ends, which can be useful for connection design.

Note:

- See the [Customizing](#) RISA-2D topic for more information about printing, including the ability to print out a RISA or custom company logo.

Printing to a File

A flat file is a file without column headings, print formatting, or graphical elements and is useful for importing and parsing into spreadsheets, database tables, or as post processor input data.

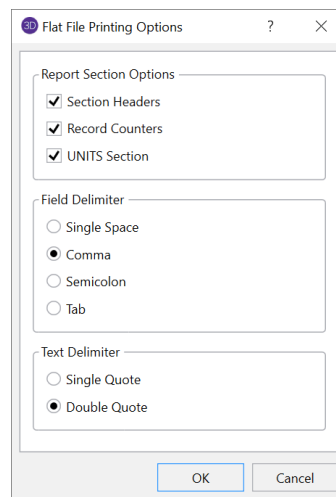

There are several options available to make the flat file easier to parse. Note that printing and then looking at a sample output file with all the options selected will make it easier to understand what the options do.

You have an option to include the 'Section Headers' which will print a text description of each block of data. For example, the Joint Coordinates data would be preceded by a [JOINT COORDINATES] header on it's own line before the data. You may also include a 'Record Count' which is useful if you're writing looping code to read in the number of records within each data block. The number of records prints on it's own line. You can also have a special 'UNITS Section' be printed out which will give you the units used for all the values in the program.

The field delimiter options let you choose what character will be used to separate each field of data within record. For example, each coordinate value in the Joint Coordinates data would be separated by the character selected. Programs that you might be importing the file into like MS Excel or MS Access often have options to select what the field delimiter will be for records of data.

The text delimiter works like the field delimiter, except that it's used to set apart text labels. All text in the flat file will be enclosed at the beginning and the end by the selected text delimiter character. This is very useful when trying to read in label strings that contain embedded spaces. As an example, the Joint labels in the Joint Coordinates data would each be enclosed by a single or double quote.

The current flat file options are saved each time the program is closed.

To Print to a Flat File

- While in the a spreadsheet click on the **Print**  button, Choose **Use Report Printing Options** and click **OK**, then choose **Write Flat File**.

Graphics Printing

Many of the same options that exist in **Report Printing** are present in **Graphic Printing**, but some unique options available are **Scale Factors** and **Title Block Info**.

These options control the graphics printing. You may choose to print in **Portrait** or **Landscape** mode.

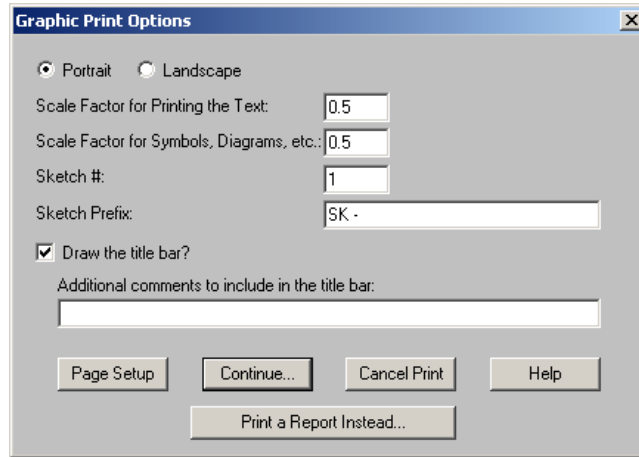

Next, two **Scale Factors** are defined. These scale factors are used to make the text and symbols displayed as part of the graphic, larger or smaller. A higher scale factor makes the text or symbol bigger. Since the resolution of the printer is probably much greater than the resolution of your screen, you can probably make the text and symbols smaller (by using a scale factor of less than 1.) than they appear on screen and they will still be easily readable. This makes for a cleaner looking graphic print. As far as what scale factors you should use, the only way to be sure is to experiment a little.

You may include the **Title Bar** to display the Model Title, Designer, Company Name, Date and Time (All of which are defined in your **Project Info**). You can also enter a comment that will be included in the Title Bar. **Page Setup** allows you to set the margins.

You can specify a **Sketch #** and a **Sketch Prefix** to label your graphic prints as well.

Once you have everything the way you want it choose **Continue**. This will bring you to the print settings that are specific to your printer. The choices are different for each printer but generally allow you to choose the printer, orientation, quality and quantity.

The bottom button **Print a Report Instead** is provided so you can get to the report printing dialog directly from a graphic view.

Results

You may work with the results of a solution by viewing and sorting data in the spreadsheets, graphically plotting them with the model or by viewing detailed member reports. You may also print the results in any of these forms. To learn about printing results, see [Printing](#).

Upon the completion of a static solution, RISA opens the **Results Toolbar** and the **Reactions Spreadsheet**. You may specify that other results be displayed automatically as well. You may then proceed to view any results and make any changes for further analysis.

If you make any changes to the model that would void the results, such as moving joints or adding members, the results will be purged and another solution will be required before the results can be viewed again.

Each of the result types is described in it's own section:

Results Spreadsheets

- [Joint Deflection Results](#)
- [Joint Reaction Results](#)
- [Story Drift Results](#)
- [Member Force Results](#)
- [Member Stress Results](#)
- [Member Deflection Results](#)
- [Hot-Rolled Code Check](#)
- [Cold-Formed Code Check](#)
- [Wood Code Check](#)
- [Concrete Design Results](#)
- [Aluminum Code Check](#)
- [Concrete Wall Results](#)
- Masonry Wall Results
- [Wood Wall Results](#)
- [Plate Stress Results](#)
- [Plate Force Results](#)
- [Plate Corner Force Results](#)
- [Modal Frequency Results](#)
- [Mode Shape Results](#)

Detail Reports

- [Member Detail Reports](#) (Hot Rolled Steel, Cold Formed Steel, & Wood)
- [Concrete Beam Detail Reports](#)
- [Concrete Column Detail Reports](#)

Saving Results

When you save a file that has been solved you may also save the results. The next time that the file is opened the saved results will be opened as well. You may use the **Application Settings** on the **Tools Menu** to change the way that you are prompted to save results.

If changes are made to the model, any saved results are deleted. Saved results for models that no longer exist in the same directory are also deleted.

Results Spreadsheets

You may access the result spreadsheets by selecting them from the **Results Menu**. You may use the **Find**, **Sort**, and **Exclude** features to find the results you are interested in. For example you might sort the member stresses from high to low, bringing all of the highly stressed members to the top. You might then exclude members that do not have significant axial stresses so that they do not distract you or so that they are not printed.

Finding Results

- To go to a certain item while in a spreadsheet click the **Find**  button, and type in the desired member, plate or joint label.

Sorting Results

- To sort the results click on the column of results you wish to sort and then click the **Sort**  button to specify sorting settings. You can sort based on maximum, minimum, absolute maximum or input order.

Excluding Results

There are ways to exclude results so that you can work with the results that are important to you.

Excluding Results Before the Solution

Excluding items before the solution allows you to remove the items from the results while leaving them as part of the model. This exclusion is permanent for that solution and any exclusion changes will then require another solution. This exclusion may be applied graphically with the **Draw** or **Modify** features or within the spreadsheets by recording an “E” in the **Inactive** field of the **Members**, **Wall Panels**, and **Plates** spreadsheets.



A member with an “E” in the “Inactive?” field will be treated like any other member in the solution and plotting of the model, but the member will not be listed in the solution results (forces, stresses, deflections, etc.). This is useful if there are certain members whose results aren't of interest. You don't have to clutter up the results with these members and can concentrate on the members you are most interested in.

Excluding Results After the Solution

You may run the solution and then graphically select the that are of interest. By clicking the **Exclude**  button, the spreadsheets and printed reports will be updated so that they will only have results for the selected items. All of the spreadsheets and reports will be controlled by this selection and you may adjust this selection at any time.

Excluding Results While in Spreadsheets

You may also select the results of interest on each spreadsheet. While viewing spreadsheet results you may select the last line of interest and exclude the rest. Exclusions are applied independently for each results spreadsheet. Any exclusion applied to the Member Forces spreadsheet will not affect the Member Stresses spreadsheet, etc. Excluding items graphically will reset **all** of the spreadsheets to match the graphic selection. If you wish to combine these two features to fine tune the results perform the graphic selection first.

To exclude results click on the last line of results you wish to keep and then click the **Exclude After**  button under the **Spreadsheets** Tab. You can bring the results back by clicking on the **UN-Exclude**  button. Alternatively, you can select these features from the Right-Click menu in any result spreadsheets.

To exclude results click on the last line of results you wish to keep and then right click and select click the **Exclude After**. You can bring the results back by right clicking in the spreadsheet and selecting **Unexclude**.



Note

- It might be best to first sort the results before excluding. As an example, let's say that you only wanted to view members with Code checks greater than or equal to 0.7. To do this you would open the Steel Code Checks spreadsheet and sort the members by Code Check magnitude. Then you would visually identify the last member with a Code Check of 0.7 and use the Exclude feature to exclude all members after that one.

Graphic Results

Most of the analysis results may be viewed graphically as well as in the spreadsheets. For the joints you may plot the reactions. For the members you may plot force diagrams as well as color-code the plotted members by code check or stress levels. Plate stress contours and corner forces may also be viewed graphically. Deflected shapes and mode shapes may be viewed and animated. See [Model Display Options](#) for more information.

To Plot Results Graphically

1. If you do not already have the model view open click the **New View**  button on the **RISA Toolbar**.
2. Click the **Model Display Options**  button on the **Window Toolbar**.
3. Select the options you would like to view and click **Apply**.

Clearing Results

You will be provided with a warning if changes are made to the model that might invalidate the current results. Should you decide to proceed, the results will automatically be cleared and you will have to re-solve the model to get results once you are finished making changes. This warning may be disabled in the **Application Settings** on the **Tools Menu**. To manually clear results, click the **Clear Results**  button.

Internal Force Summation Tool

This tool may be activated by clicking the  icon below the Selection Toolbar or by using the Right-Click menu from within a model view. The tool is only available from within a model view that has active results for a single combination or a batch solution. This tool is not currently available for an envelope solution.

This tool was originally created to convert Plate Analysis results into design forces for concrete slabs and walls. However, the tool is equally useful for structure that have beams, columns and braces. It is frequently used to determine overall story shears and moments. For detailed information on the tool, please refer to the [Plate Design Tools](#) section.

Note

- The internal force summation tool does NOT currently work on Solid Elements.

Member Detail Report

The detail report allows you to see the overall force/stress/deflection state for any particular member. This report shows diagrams for all these quantities and also lists detailed information on the code checks for Hot Rolled Steel, Cold Formed Steel, Concrete, Aluminum and Timber design.

This detail report is available for any member following the solution. If you have run an envelope solution, then you will only be able to view an enveloped detail report. If you run a Batch + Envelope solution, you can scroll between individual (Batch) load combination results, and the Enveloped results.

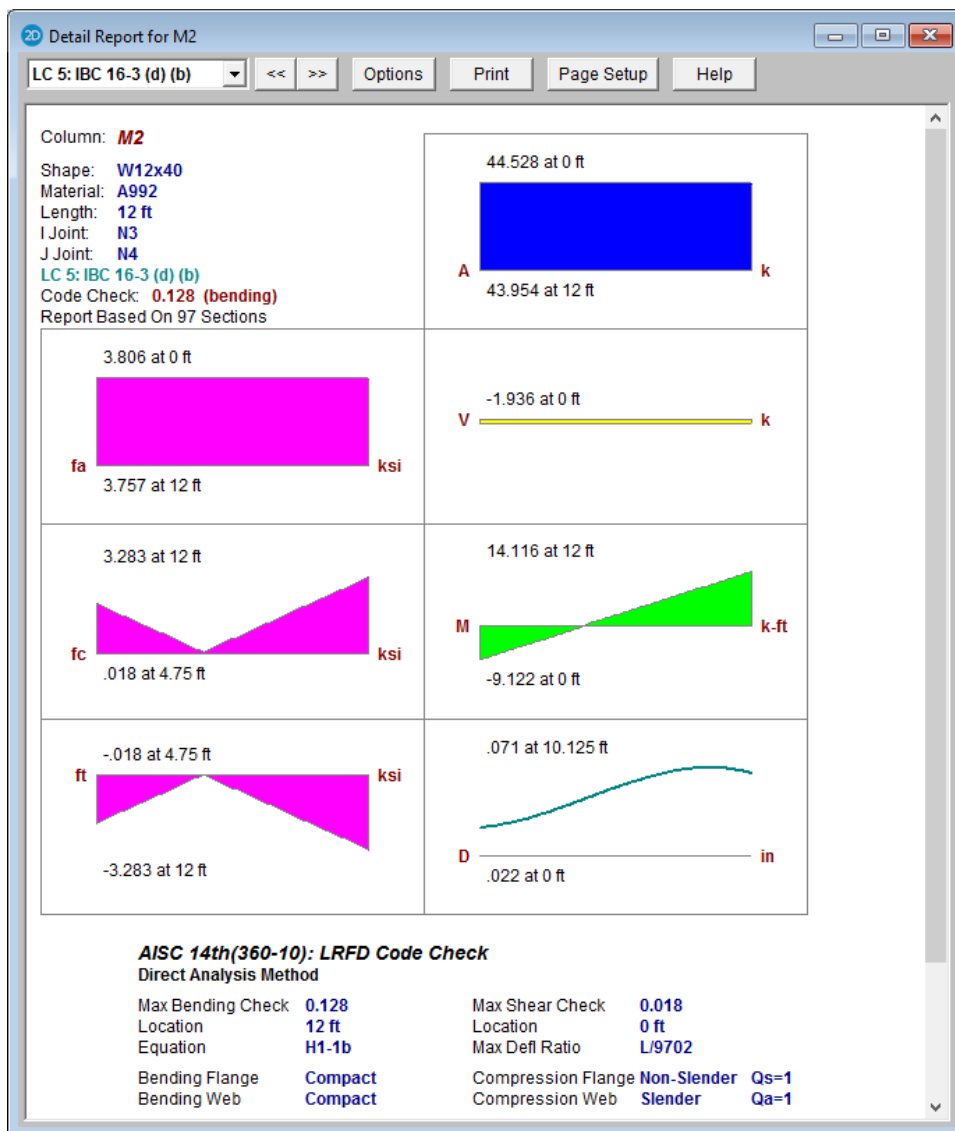

- If there is a (y) or (z) value next to the code check, it defines whether the controlling case is in the local y or z axes respectively.

- If there is an (s) this tells you that the maximum check occurred at some other axes where a round shape is used and the cross-sectional properties for the member are the same in all directions.
- If you are viewing an enveloped detail report, the governing load combination number will be reported in parenthesis. Ex: (LC 10).
- When a force or stress shows up with multiple colors (see image below), this signifies the difference between the total value and the value when Live Load Reduction is considered.
- The viewing of Live Load Reduction within the diagrams and the consideration of LL reduction in the reported values can be turned on or off by clicking on the **Options** button.
- For members designated as beams, the Max Defl Ratio will report the maximum beam deflection ratio (L'/y') as reported in the [Beam Defl](#) tab of the Member Deflections spreadsheet.
- For members that are not designated as beams, the Max Defl Ratio will report the maximum member deflection ratio (L/y') as reported in the [Service](#) or [Strength](#) tab of the Member Deflections spreadsheet.



To View a Detail Report

- To view a member detail report after running a solution, click on the **Detail** button on the Selection toolbar and then click on that member. If you do not already have the model view open click the

- **New View**  button on the RISA toolbar.
- You may also access the detail report while viewing a member results spreadsheet such as **Member Stresses** by clicking the  button on the Window toolbar. You can also access the detail report from the Right-Click menu in a member results spreadsheet.
- You may also use the **Results** ▶ **Members** ▶ **Detail Report** menu option to open the report for any member.

Note:

-  - This button will allow you to take a snapshot of the current detail report you are viewing so that it can be added to your printed report. View the [Printing](#) topic for more information.

Interactive Diagrams

Once a detail report is open, you can also click on any of the force, stress, or deflection diagrams to open an interactive diagram. Use the cursor at the bottom to drag along the length of the member to see how the value changes.

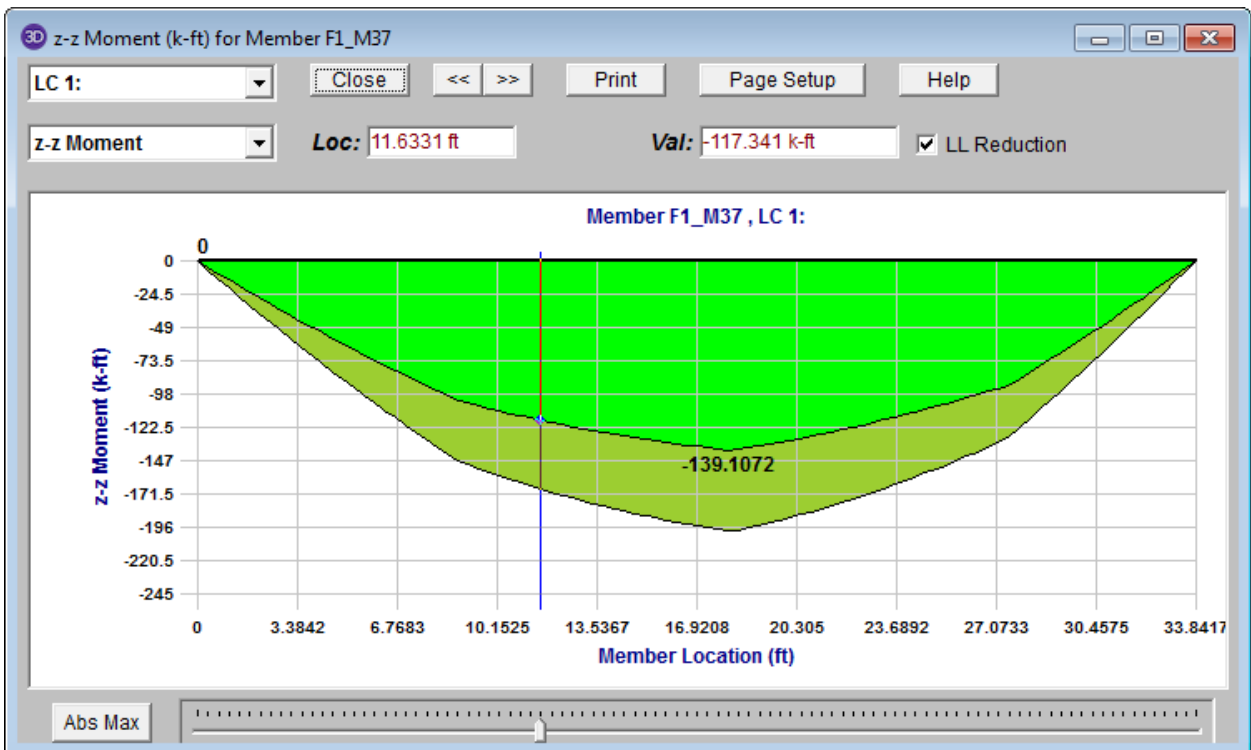

The diagrams provided are:

Plot Designation	Plotted Value
A	Axial Force
V	Shear Force
M	Bending Moment
D	Deflection
fa	Axial Stress
fc	Bending Compressive Stress
ft	Bending Tension Stress

Plot Designation	Plotted Value
f(y)	(Envelope Only)

The "fa" stresses are the stresses resulting from the axial force. The "fc" and "ft" stresses incorporate bending moment stresses. In the envelope detail report, the "f(y)" stresses display both the maximum positive and negative bending stress located at the extreme fiber of the member in the local y-axis. These stresses are listed in the Member Stresses spreadsheet as y-Top and y-Bot.

The diagrams are scaled in groups to give a good representation of relative values. For example, the force diagrams (A, Vy and Vz) are scaled such that the force of maximum magnitude fills the diagram space. The other diagrams are then plotted using that same scale. The moments, deflections and stresses are similarly scaled together.

When an output file is saved, the program will discard much of the unneeded force, moment and deflection data used to create the detail report plots. When this saved file is later retrieved, these plots will appear more coarse and inexact. However, the maximums, minimums and controlling code checks are always maintained regardless of how coarse the plots appear.

Tapered Members

The Detail Reports for tapered members designed to AISC Design Guide 25 contain information not available in other Hot Rolled Steel Design Reports. Refer to the [Tapered Member Results](#) sub-topic of Hot Rolled Steel Design for more information.

Envelope Member Detail Reports

The Detail Reports can be viewed for single load combinations, or as an envelope. If you solve a Batch + Envelope solution, you can toggle between the overall enveloped results and the individual load combination results using the menu at the top left.

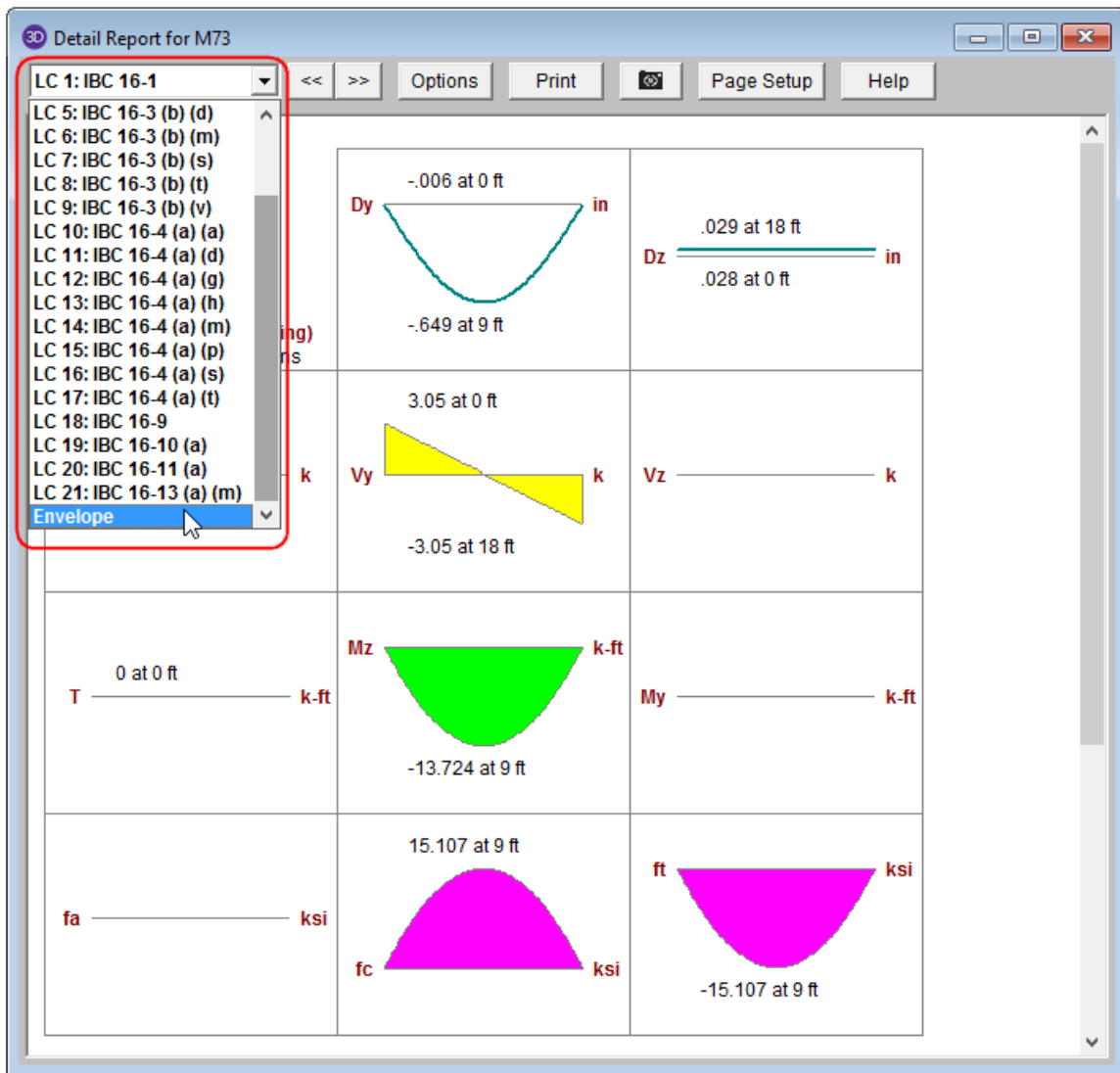

For the enveloped report, all diagrams will show enveloped data. Governing load combinations will be noted in parenthesis.

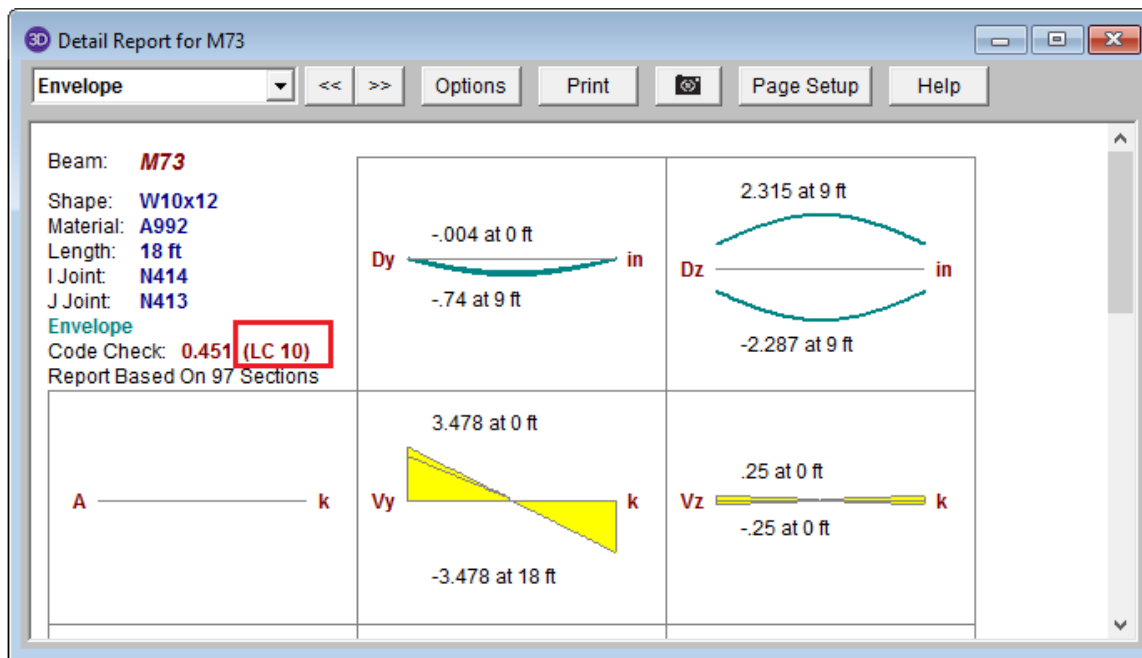
**Note:**

- If you solve a load combination with a Moving Load or a Time History Load, the results will only be available in the enveloped detail report..
- To control whether the displayed diagrams and values consider LL Reduction, click on the **Options** button.

Concrete Member Detail Reports

Concrete member detail reports are similar in function to detail reports for other materials, but they are different in the type and amount of information they convey. One of the largest differences is that the force diagrams are always **envelope** force diagrams, because the majority of the concrete design results are based on the envelope forces.



The detail reports for concrete Beams and Columns are discussed in greater detail in the [Concrete - Design Results](#) section.

Section Sets

Cross-section properties may be assigned to members in one of two ways; either by choosing a shape directly from the steel database, or by using a section set. Section sets provide a way to group members so that they have the same properties. Adjusting the set properties, rather than selecting and adjusting each member can achieve changes to the properties for all of the members in the set. You must use section sets if you want to perform timber code checks or steel shape optimization.

The cross section data for the members is recorded on the **Section Sets** spreadsheet. Cross sectional properties can be entered manually or may be retrieved from one of the shape databases. Currently the databases include Hot Rolled Steel, Cold Formed Steel, Wood, Concrete, and Aluminum. Once the section is defined, it is then referenced on the **Members** spreadsheet when assigning properties to a member.

To Define a New Section Set

1. On the **Spreadsheets** menu click on **Section** to open the spreadsheet.
2. Select the tab for the Material type that you will be using
3. Enter the section set label and other information. You may choose the material by clicking on the arrow  in the cells.
4. You may open the database by clicking on the arrow  in the **Shape** column.

Note:

- If you leave the Shape name blank for **General Sections**, then you may enter the rest of the properties (A, I, J) yourself without having to define an arbitrary shape.
- For rectangular, circular, and pipe shapes you can use the On-Line shapes to automatically define the shape properties. See [On-Line Shapes](#).

Section Sets Spreadsheet

The **Section Sets** spreadsheet records the section properties for the member elements and may be accessed by selecting **Sections** on the **Spreadsheets** menu .

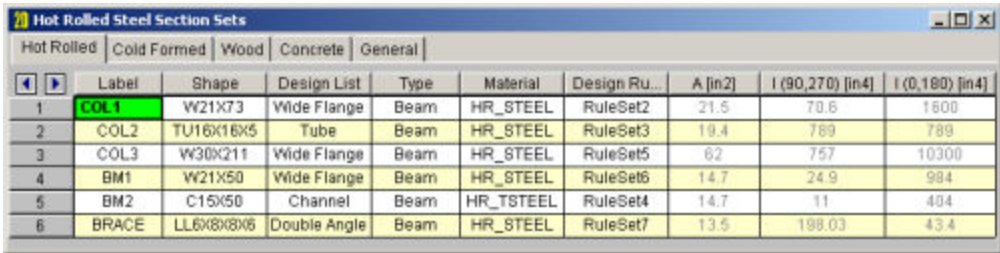

	Label	Shape	Design List	Type	Material	Design Ru...	A [in2]	I (90,270) [in4]	I (0,180) [in4]
1	COL1	W21X73	Wide Flange	Beam	HR_STEEL	RuleSet2	21.5	70.6	1800
2	COL2	TU16X16X5	Tube	Beam	HR_STEEL	RuleSet3	19.4	789	789
3	COL3	W30X211	Wide Flange	Beam	HR_STEEL	RuleSet5	62	757	10300
4	BM1	W21X50	Wide Flange	Beam	HR_STEEL	RuleSet6	14.7	24.9	984
5	BM2	C15X50	Channel	Beam	HR_STEEL	RuleSet4	14.7	11	404
6	BRACE	LL6X8X8X6	Double Angle	Beam	HR_STEEL	RuleSet7	13.5	198.03	43.4

The following are input columns on the spreadsheet that may be used to specify cross section data for the members in the model.

Section Label

The **Section Label** is the label you'll reference on the **Members** spreadsheet to assign properties to a member. This label can be anything you wish, so long as it's not the same as any other section set label.

Section Database Shape

The **Shape** field is used to obtain properties from the shape databases. To use the database, simply enter the name of the database shape and the shape properties (A, I, J) will be filled in automatically. Click  to pick from the database.

If you don't want to use a database shape and wish to enter the shape properties directly, just leave this field blank.

Note:

- For rectangular, circular, and pipe shapes you can use the On-Line shapes to automatically define the shape properties. See [On-Line Shapes](#).

Section Material

The **Material** field is used to enter the label of the material. The material must be defined on the **Materials** spreadsheet or on the **Wood Properties** spreadsheet.

Member Type

Enter the member type for the section set. The choices are *Column, Beam, Vertical Brace, and Horizontal Brace*.

Here are the main effects that the member type will have on your structure:

1. If using concretemembers, this will define the rebar layout (column vs beam) .
2. If using design lists, they specifically reference the member type.
3. If using member area loads, loads will not be attributed to members defined as Hbraces or Vbraces.
4. If using the RISA-Revit link the link will not work properly unless you use member types.
5. If integrating with RISACconnection, the connection validation requires proper use of member types.
6. If using the seismic detailing provisions then you must use proper member types.

Design List

Enter the **design list** type that you wish to use for this section set. This entry will affect the members that are available to program when it is suggesting alternate or optimized shapes. Refer to [Design Optimization](#) for more information on the member optimization procedure. Also refer to [Appendix A – Redesign Lists](#) for information on creating or editing these lists.

Design Rules

Enter the **design rules** type that you wish to use for this section set. When the program is checking alternate or optimized shapes, it will restrict its selections to members that obey the chosen design rules. Refer to [Design Rules- Size / U.C.](#) for more information.

Cross Section Properties

The cross section properties will be filled in automatically if you use a database shape. For **General Materials**, you may leave the shape field blank and enter these directly. **I(90,270)** and **Izz(0,180)** are for bending about the respective member local axes. The 0, 90, 180 and 270 designations indicate the rotation (in degrees) of the member. If the member has been rotated 90 or 270 degrees the **I(90,270)** value is used, otherwise the **I(0,180)** value is used. Note that it's not a good idea to edit these fields if you already have a database shape assigned. Any changes will not be saved and will be replaced with the original values when the file is reopened or the shape is reentered in some other manner. You should create a new shape in the database to avoid this situation.

Note:

- For Tapered WF shapes, only the shape properties at the I-end will be shown on the **Section Sets** spreadsheet. To view properties for both ends use the **Edit** button in the **Shape Selection** settings.

Shape Databases

For each material, there are several databases of common structural shapes such as Hot Rolled Steel Wide Flanges, Cold Formed Shapes, Wood, Concrete Tees, etc. You may also choose from shapes created in RISASection. You may type in the names directly, select shapes from these databases or add your own shapes.

Database Shape Types

There are different types of shapes for each material type including General shapes. Names for each shape type follow a syntax so that they may be typed directly into the **Shape** field on the **Section Sets** spreadsheet or on the **Primary** tab of the **Members** spreadsheet. Alternately you may click the  button to look up a shape and select it.

Hot Rolled Shapes

AISC, Canadian, Trade Arbed and custom Hot Rolled shapes are accessed by clicking the **Edit Shape Database**  button from the **RISA Toolbar**, and then clicking the **Hot Rolled** tab from within the **Shape Database Editor** dialog. The hot rolled shapes and databases are more fully described in the Hot Rolled Steel Design section. See Hot Rolled Steel Databases for more information.

Virtual Joists and Virtual Joist Girders

The Steel Joist Institute (SJI) has put together Virtual Joist and Virtual Joist Girder tables which convert common joist and joist girder sizes into equivalent wide flange beams. These shapes are available by selecting **Virtual Joist Girder** or **Virtual Joist** from the **Database/Manufacturer** menu. For additional advice on this topic, please see the RISA Tips & Tricks webpage at risa.com/post/support. Type in Search keywords: **Virtual Joist Girders**

Cold Formed Shapes

Manufacturer and custom cold formed shapes are accessed by clicking the **Edit Shape Database**  button from the **RISA Toolbar**, and then clicking the **Cold Formed** tab from within the **Shape Database Editor** dialog. The cold formed shapes and database are more fully described in the Cold Formed Design section. See [Cold Formed Steel Databases](#) for more information.

Concrete Shapes

Concrete shapes do not have a predefined database like hot rolled and cold formed steel. Instead, they are defined using a parametric shape code that may be assigned any depth or width. There are two types of shapes currently supported: Rectangular and Round. See [Concrete Database](#) for more information.

Wood Shapes

The available wood shapes are based on the dimension lumber and post and timber shapes given in the NDS or CSA O86, depending on what code you have chosen as your Wood design code. You may also design for multiple plies of these shapes. Note that the NDS dimension lumber shapes are all *nominal* sizes. CSA O86 shapes are *actual* sizes.

Allowable stress values for each shape are based on the species and grade information given in the selected design code. See [Wood Database](#) for more information.

Aluminum Shapes

US, Canadian and custom Aluminum shapes are accessed by clicking the **Edit Shape Database**  button from the **RISA Toolbar**, and then clicking the **Aluminum** tab from within the Shape Database Editor dialog. The aluminum shapes and databases are more fully described in the [Aluminum - Databases](#) section.

General Shapes

Arbitrary Shapes

Arbitrary Shapes are a special, catch-all shape. This arbitrary shape type is provided so that any shape can be added to the shape database.

AISC code checks are not calculated for arbitrary shapes since their place in the specification is unknown. Everything else will be calculated for them (forces, deflections, stresses). The max thickness (Max thick) value for the cross section is used to determine the pure torsional shear stress for the shape. "J" is the torsional constant. The "d" values (the distances to the extreme fibers) allow the program to calculate stresses at the extreme fibers.

Note:

- These shapes will generally be rendered using a greenish cruciform shape. The center of the cruciform will reflect the centroid of the section with the tips of the cruciform representing the distances from the neutral axis to the extreme fiber.
- Refer to [Member Shear Deformations](#) and [Member Shear Stresses](#) for more information on the shear area factors (As-zz Def, As-yy Def, .As-zz Stress, & As-yy Stress) shown in the figure below.

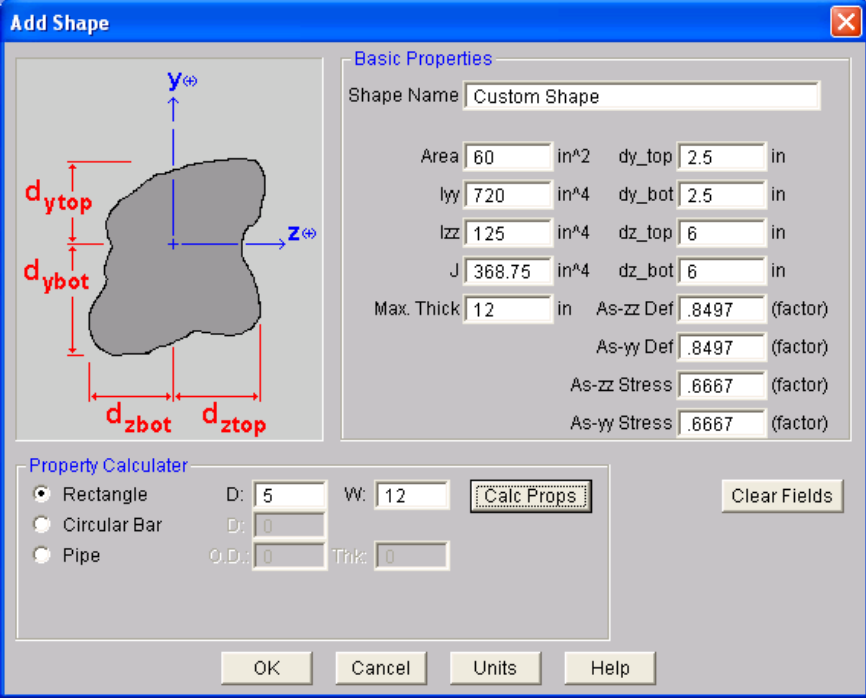

Add Shape

Basic Properties

Shape Name: Custom Shape

Area: 60 in² dy_top: 2.5 in

Iyy: 720 in⁴ dy_bot: 2.5 in

Izz: 125 in⁴ dz_top: 6 in

J: 368.75 in⁴ dz_bot: 6 in

Max. Thick: 12 in As-zz Def: .8497 (factor)

As-yy Def: .8497 (factor)

As-zz Stress: .6667 (factor)

As-yy Stress: .6667 (factor)

Property Calculator

Rectangle D: 5 W: 12 **Calc Props** Clear Fields

Circular Bar D: 0

Pipe O.D.: 0 Thk: 0

OK Cancel Units Help

To Add an Arbitrary Shape to the Database

- To enter an arbitrary shape in the database, click the **Edit Shape Database**  button from the **RISA Toolbar**, and then clicking the **General** tab from within the Shape Database Editor dialog. Set the shape type to Arbitrary, click **Add** and then enter the shape name and properties.

RISASection Files

You may create simple or complex sections in RISASection and then import those sections for use in your model. Sections that exist in RISASection (files located in the "RISASection" file specified in **Tools - Application Settings - File Locations**) will be available for use in the model. Each section must have a unique name for it to be available.

The shapes that are designated as General Material, Arbitrary Shape Type in RISASection will show up in the **General** tab under the "**RISASection**" **Database/Manufacturer**.

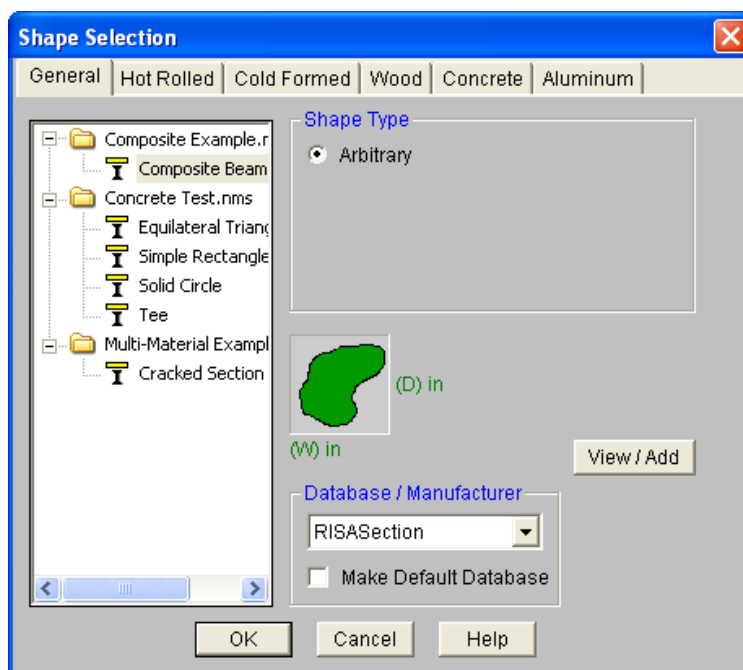

The shapes that are designated as Hot Rolled Steel Material in RISASection will show up in the **Hot Rolled** tab under the appropriate Shape Type (Channel, Wide Flange, etc.) when "**RISASection**" is selected as the **Database/Manufacturer**.

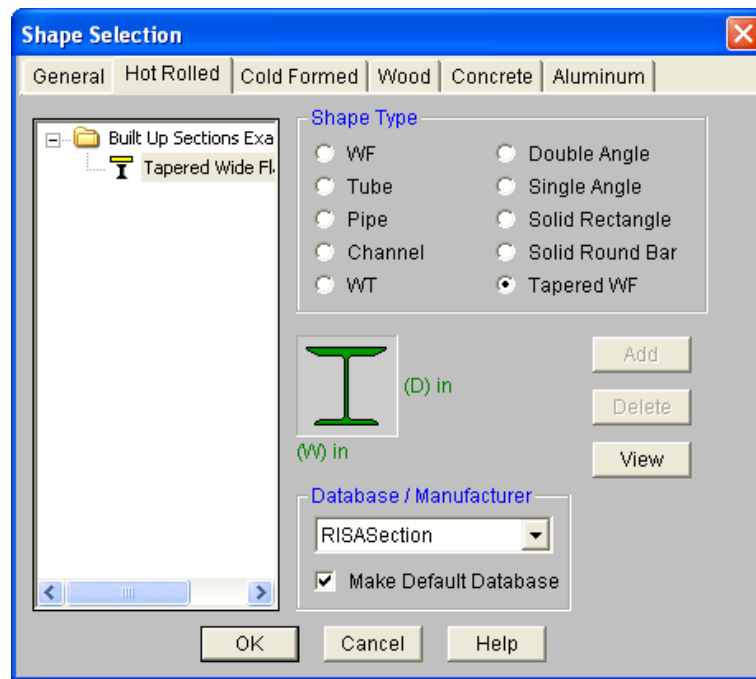

Note: Currently, RISASection can only import General and Hot Rolled Steel shapes. More material choices will be available in a future version.

For additional advice on this topic, please see the RISA Tips & Tricks webpage at risa.com/post/support. Type in Search keywords: **RISASection Integration**.

Troubleshooting RISASection / RISA-2D Interaction

There are a few common issues that arise when attempting to access RISASection files from within RISA-2D.

- When RISA-2D launches, it will only import RISASection files that exist in the directory specified in **Tools - Application Settings - File Locations**.
- RISA-2D only reads in database files when it is first launched. Therefore, if a RISASection file is created or modified, then RISA-2D must be closed and re-started before it will recognize the new or modified section.

There are some common mistakes that are made from within the RISASection program that may cause an issue when trying to read that shape from within RISA-2D.

- The name of the RISASection "File" is actually different from the name of the section itself. Both names will appear in the RISA-2D database, but it is important to give your sections unique names in order to properly tell them apart. Note: each RISASection file can contain many different sections. Hence the need to name each individual section.
- Unless specifically identified as a Hot Rolled Material type and shape (from within RISASection), the shapes will be imported as Arbitrary shapes with a General Material type
- RISASection can save files with a new *.nmsx file type (for RISASection 2.0 or higher), or an old *.nms (for RISASection version 1.1 or older). If saved as the old file type, the sections will only come in as Arbitrary members with a General material type.
- If the file is saved with a *.nmsx extension it will not be read into older versions of the RISA programs (prior to RISA-3D version 9.1.1).

Structural Desktop (SDT) Shapes

The SDT database is provided by the Structural Desktop software in a file called SDT.FIL. Structural Desktop automates drawing production of RISA models. The SDT database is provided for shapes that are not directly

supported in RISA models (such as bar joists) but are available in Structural Desktop. For more information on Structural Desktop see www.structuraldesktop.com.

On-Line Shapes

On-Line shapes are shapes whose dimensions are defined directly in the syntax of the shape name. On-line shapes are not stored in the shape database because there is enough information from the label syntax to calculate all the shape properties. A pipe, for example, can be fully defined by specifying the thickness and diameter.

These shapes are treated just like database shapes for stress calculations. Currently, Pipes, Solid Rectangular and Solid Circular shapes are defined on-line as discussed below in Pipe Database Shapes, Solid Rectangular Shapes, and Solid Circular Shapes.

Pipe Database Shapes

Pipe shapes, which are hollow circular shapes, are entered as on-line shapes. The syntax for these shapes is "PIdiaXthick", where "dia" is the pipe outside diameter and "thick" is the pipe thickness (in inches or centimeters). For example (assuming US Standard units), PI10X.5 would be a 10" diameter pipe with a wall thickness of 1/2".

Solid Rectangular Shapes

These shapes can be defined as on-line shapes. The syntax is "REhtXbase", where "ht" is the rectangle height and "base" is the rectangle base (in inches or cm). For example, RE10X4 would be a 10" deep, 4" width rectangular shape (assuming US Standard units). These shapes can also be defined in the Shape Editor. When defined in the Shape Editor the depth of the solid rectangular section must always be greater than or equal to the width.

Solid Circular Shapes

These shapes are defined as on-line shapes. The syntax is "BARdia", where "dia" is the circle diameter. For example (assuming metric units), BAR2 would be a circular bar with a diameter of 2 cm.

Database Files

The shape databases are stored in the database files (*.FIL). These files may only be edited through the program. The path to these files is set in the **File Locations** tab of **Application Settings**, which is found in the **Tools** menu.

After adding a new shape in your model, you will be prompted with this Changes to Shape Database dialog. Click 'Yes' if you want to add the shape to your Shape Database to be available for all future models. Click 'No' if you do not want the new shape to be available for other models, this will not save the shape to your Shape Database.

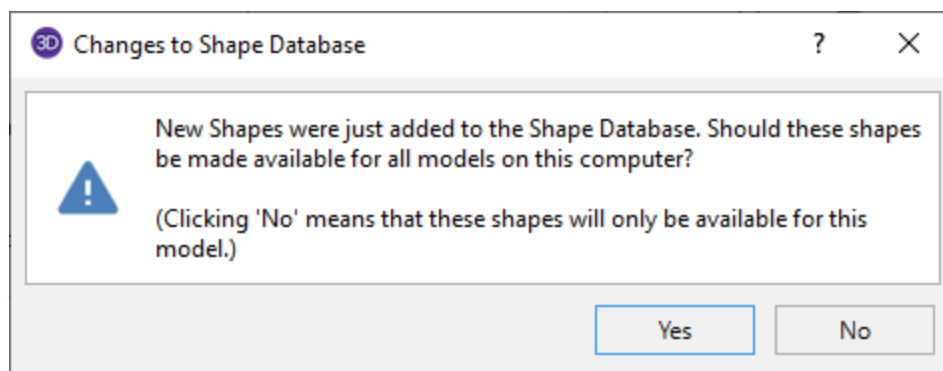

You can also make edits to the geometric and section properties of the shapes in your Shape Database. If you modify geometric properties, you can also use the Re-Calc button for the program to automatically calculate the corresponding section properties.

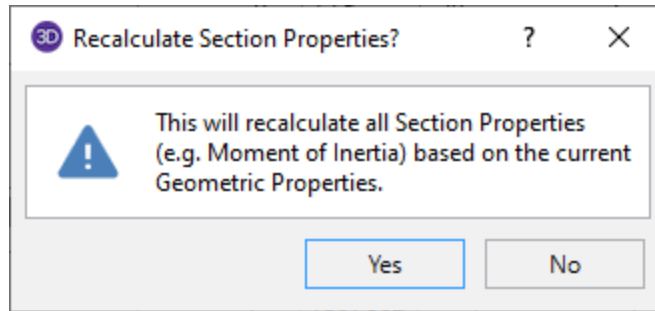

After editing the geometric or section properties for a shape in your model, you will be prompted with this Changes to Shape Database dialog. Click 'Yes' if you want to add the shape modifications to your Shape Database to be available for all future models. Click 'No' if you do not want the changes to apply to other models, this will not save the changes in the Shape Database for other models.

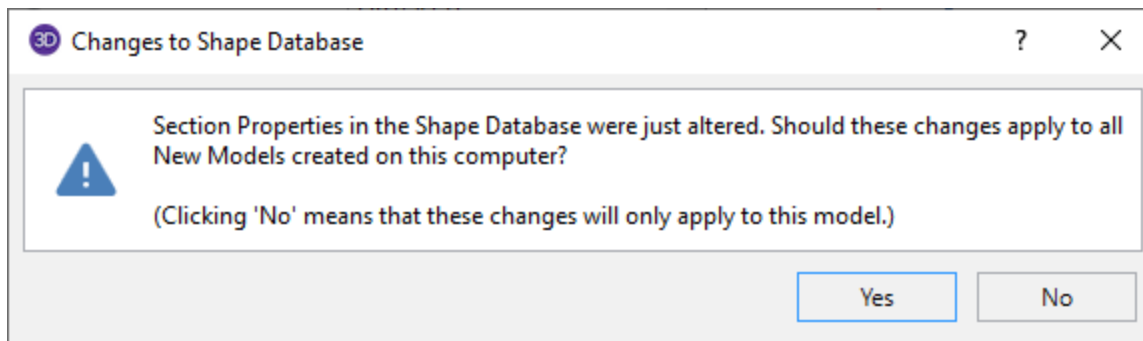

Note

- Alterations to the shape databases are not permanent unless you agree to save them. Changes that are not saved only remain valid for the current session and will not be present the next time you start RISA.
- New shapes are always added to the bottom of the database.
- To delete a shape specify the database and shape type you wish to delete and then click the **Delete** button.
- To edit a shape click the **Edit** button and edit the shape properties. Values can only be manually edited here, nothing will be recalculated. If you wish to have all the values for a shape recalculated, you will need to delete the shape and then add it again with the new properties. For Tapered WF shapes only, you can click **Calc Props** to recalculate the shape properties based on the basic dimensions. Tapered WF shapes are stored parametrically, so there are no database values to edit since they are calculated on the fly whenever an analysis is performed.

Solution

Note:

- The linear-elastic behavior of the program implicitly means that non-linear (2nd order) behavior is not generally supported. Tension-structures such as guy cables or fabric structures would fall into this non-linear category. Please see the [Modeling Tips](#) section for some ways to approximate this behavior. This note applies to all elements in the program (wall panels, plates, members, etc.).

Four solution options are presented when you click **Solve** on the menu. Some of the options require other solution types to be performed. See [Results](#) for information on solution results. For additional information on [Dynamic Analysis](#) and [Response Spectra Analysis](#) results refer directly to those sections. For footing design within RISA-3D or RISA-2D see the Footing Design topic. For connection design within RISA-3D see the RISAConnection Integration topic.

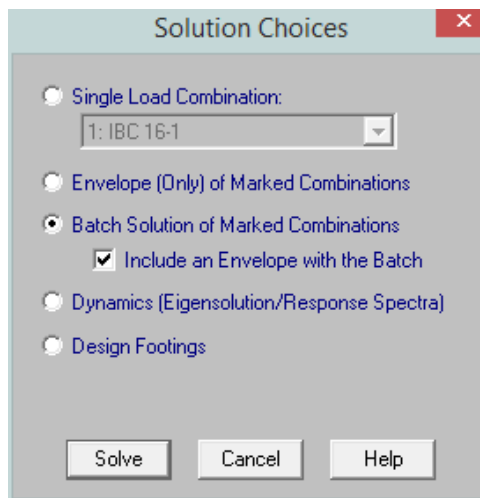



What do you want to do?

- [Perform a dynamic analysis.](#)
- [Perform a response spectra analysis.](#)
- [Perform a Time History solution.](#)
- [Perform a Static Solution](#)

What do you want to know?

- [What is an Envelope Solution?](#)
- [What is an Batch Solution?](#)

Static Solutions / Stiffness Matrix

Static solutions are based on load combinations and may be performed on any defined load combinations. When a static solution has been performed and the results are available the "S" icon on the status bar in the lower left corner will change from  to . If any changes are made to the model that invalidate the results then the results will be cleared and another solution will be necessary.

The solution is based on the widely accepted linear elastic stiffness method for solution of the model. The stiffness of each element of the structure is calculated independently. These element stiffnesses are then combined to produce the model's overall (global) stiffness matrix. This global matrix is then solved versus the applied loads to calculate joint deflections. These joint deflections are then used to calculate the individual

element stresses. The primary reference for the procedures used is **Finite Element Procedures**, by K. J. Bathe (Prentice-Hall, 1996).

Skyline Solver

This solution method is also sometimes referred to as an Active Column solution method. In finite element analysis, the nonzero terms of the stiffness matrix are always clustered around the main diagonal of the stiffness matrix. Therefore, the Skyline or Active Column solutions take advantage of this by condensing the stiffness matrix to exclude any zero stiffness terms that exist beyond the last non-zero term in that column of the matrix.

Since the majority of terms in a stiffness matrix are zero stiffness terms, this method greatly reduces the storage requirements needed to store the full stiffness matrix. However, for large models (+10,000 joints), the memory requirements even for a skyline solution can be problematic.

This solution method has been used successfully in RISA for more than 20 years, and has proven its accuracy continuously during that time.

Single Combination Solutions

Choose this option to solve one load combination by itself.

Envelope Solutions

Static solutions may also be performed on multiple combinations and the results enveloped to show only the minimum and maximum results. Each of the results spreadsheets will contain minimum and maximum values for each result and also the corresponding load combination. The member detail report and deflected shape plots are not available for envelope solutions. See [Load Combinations](#) to learn how to mark combinations for an envelope solution.



Batch Solutions

Static solutions may be performed on multiple combinations and the results retained for **each** solution. When performing a batch solution, you have the option to also include a set of envelope results. This is useful when an envelope result is desired to quickly determine a controlling load combination, but when the investigation of that load combination required the greater details given with batch solution results. When using the Batch + Envelope Solution, to view the envelope results, click on a spreadsheet in the Results toolbar. To view the batch results, click on that same spreadsheet in the Results toolbar a second time. Both the envelope and batch solution spreadsheets should now be available simultaneously.

You may group the results by item or by load combination by choosing from the **Results Presentation** options on the **Results Menu**. For example you can have all the combination results for member M1 together or you can have all the member results for Load Combination "D+L" together. See [Load Combinations](#) to learn how to mark combinations for a batch solution.

Dynamic Solutions - Eigenvalues & Mode Shapes

In this section, the term "Dynamic Solutions" refers to solving of the dynamic properties of a structure. This involves assembling the mass matrix, solving for the eigen values (natural periods / frequencies), as well as determining the mode shapes of vibration associated with each period / frequency. Dynamic analysis requires a load combination, but this combination is merely used to determine the mass of the model. See [Dynamic \(Modal\) Analysis](#) for much more information.

When a dynamic solution has been performed and the results are available the "D" icon on the status bar in the lower left corner will change from  to . If any changes are made to the mode that invalidates the results then the results will be cleared and another solution is necessary.

Accelerated Solver

The Accelerated Solver is actually three solvers in one: A Direct Jacobian, an Accelerated Sub-Space solver, and a Lanczos Solver. Each of these solvers will have a certain range of models for which it is most efficient. Therefore, RISA will automatically detect which should be most efficient for the given model and use that solver for the eigen-solution. This solver is much more efficient than the standard solver and will find frequencies and mode shapes in a fraction of the time the standard solver. Therefore, it is the default solution option.

Standard Solver

This solver uses sub-space iteration to solve for the Eigen values. This solver has been used for years and the accuracy of the results is very well established. It has been included mostly for comparative / verification purposes.

Ritz Vector Solver



This solver uses Load Dependent Ritz (LDR) vectors to bias the dynamic solution. This means that the solution does not necessarily represent the true mode shapes or natural frequencies of the structure. As such, this solution should not be used in cases where the natural frequencies and modes shapes are the main goal.

Ritz vectors are derived by using a static displacement vector as the basis of the derived vector, only allowing for the solution of modes / vectors that will be excited by the initial loading or which will contribute to the total response. In RISA, the initial static displacement vectors are based on the load combination used for the definition of [dynamic mass](#). The mass defined in this load combination is converted into a static load in each direction for which a Response Spectra solution is requested. The solution of which forms the basis for the initial Ritz Vectors.

Note:

- For cases where the mode shapes and frequencies are used to estimate dynamic response (i.e. Response Spectra or Time History analysis), it has been demonstrated that using Ritz vectors can produce a more accurate response than would be obtained using the same number of true eigen modes.
- It is possible, however, for there to be some frequency shift in the mass participation. For the case of earthquake response of a typical building structure, this frequency shift should result in a more conservative base shear than would be produced by a true eigen solution producing the same amount of mass participation.
- In particular Ritz Vectors are useful for cases in which it is difficult to obtain the desired level of mass participation with a traditional eigen value analysis. This is because Ritz vectors are biased towards a presumed deflected shape.
- When Ritz Vectors are used for a Time History analysis the LC used as the basis for the dynamic mass should contain TH loading at the main joints of the structure. The program will detect this and then include the Time History Load function in the initial static displacement vector. This doesn't change the mass matrix at all. But, it will bias the Ritz Vectors to displacements at those joints which leads to a more accurate Time History response with fewer modes.

Dynamic Solutions - Response Spectra

- Whenever a dynamic / eigen solution has been performed the "D" icon on the status bar in the lower left corner will change from  to .
- If any changes are made to the model that invalidate these dynamic results (even if they don't invalidate the mass matrix), the dynamic results will be cleared and need to be re-solved before a time history analysis can be performed.

Note:

- Alpha will default to zero, at which point the solution is identical to the Newmark Beta method using integration constants $\beta = 0.25$ and $\gamma = 0.5$.
- A negative value for alpha is often used when the desire is to dissipate energy associated with higher frequency response. This makes the HHT solution methodology more stable than other solution methods, and may allow the user to set their integration time step slightly larger to improve time history solution speed. Refer to topic Dynamic Analysis - Time History for more information on setting time steps.
- RISA requires an Eigensolution or Ritz Vector solution even when Direct Integration is used. Refer to Required Number of Modes for a discussion on this topic.

Spreadsheet Operations

Powerful spreadsheets may be used to view, sort and edit the input data and results. The spreadsheets and model views are synchronized, unless you turn this feature off in the **Application Settings** on the **Tools Menu**. As you edit a model graphically the spreadsheets are automatically updated and as you make changes in the spreadsheets the model views reflect these changes immediately.

The input data may be accessed from the **Spreadsheets Menu**. You may edit the data or you can add new data. You can also paste data from another application directly into the spreadsheet via the Windows clipboard. Any changes made to the input spreadsheets may also be viewed graphically.

After solving the model, results are recorded in spreadsheets for browsing. These spreadsheets may be accessed from the **Results Menu**. You may sort the results in order to find maximums and exclude data that is not important. You may also copy this data to the Windows clipboard and use it in another application.

For additional advice on this topic, please see the RISA Tips & Tricks webpage at risa.com/post/support. Type in Search keywords: **Advanced Spreadsheet**.

Moving and Scrolling

To move between cells in a spreadsheet, click any cell or use the keyboard arrow keys. When you move to a cell it becomes the active cell. To see a different area of the spreadsheet use the vertical scroll bars on the right side of the spreadsheet.

To Scroll	Do This
One row up or down	Click the arrows on the vertical scroll bar.
One column left or right	Click the arrows on the horizontal scroll bar.
One page up or down	Click above or below the scroll box in the vertical scroll bar.
One page left or right	Click to the left or right of the scroll box in the horizontal scroll bar.
A large distance	Drag the scroll box to the approximate relative position.

Note:

- The size of a scroll box indicates the proportional amount of the spreadsheet that is visible. The position of a scroll box indicates the current location relative to the spreadsheet.
- The mouse wheel is also an excellent tool for scrolling up and down in spreadsheets or graphics. Roll the wheel or click and drag to move around.

Spreadsheet Keyboard Commands

The following keyboard commands are available:

Key	Function
Arrow Keys	Move the active cell one location

Key	Function
TAB	Move right one cell
ENTER	Move to the first column of the next line. Adds new line if necessary.
PAGE UP	Move the active cell one full page up.
PAGE DOWN	Move the active cell one full page down.
HOME	Move to the first line of the spreadsheet.
END	Move to the last line of the spreadsheet.
F3	Insert new line below current line.
F4	Delete current line.
F8	Insert new line below current line and repeat the current values in the new line.

Selecting Spreadsheet Cells

Before you can carry out commands or tasks in a spreadsheet, you must select the cells that you want to work with.

To Select	Do This
A single cell	Click the cell, or press the arrow keys to move to the cell.
A range of cells	Click the first cell of the range, and then drag to the last cell.
An entire row	Click the row heading.
An entire column	Click the column heading.
Adjacent rows or columns	Drag across the row or column headings

Note:

- To cancel a selection of cells, click any single cell in the spreadsheet.

Undoing Operations

RISA-2D provides you with virtually unlimited **Undo** capability so that you may easily correct mistakes or just back up to try different possibilities. Simply click the Undo button  as many times as you wish to go back a step. The model view and the spreadsheets will visually display the "undoing". Remember that graphic edits are undone as well.

Redoing Operations

RISA-2D provides you with virtually unlimited **Redo** capability so that you may reapply actions that were previously undone. Simply click the Redo button  as many times as the Undo button was used just prior. The

model view and the spreadsheets will visually display the "redoing". Remember that graphic edits are redone as well.

Editing Spreadsheets

The spreadsheets have been specifically developed for the input and editing of structural models. There are many ways to edit the spreadsheets allowing you to quickly build your model. You may copy and move data from other locations or other files. You may also fill large blocks of cells automatically and perform math on these cells.

To Change Basic Load Cases in a Load Spreadsheets

- Use the drop down load list  on the window toolbar to control the basic load case in a load spreadsheet.

To Fill Selected Cells

1. Select the cells you wish to fill.
2. Click the **Block Fill**  button.
3. Type the value you wish to apply.
4. Click **OK**.



To Perform Math on Selected Cells

1. Select the desired cells.
2. Click the **Block Math**  button.
3. Specify the value and the operation you wish to apply.
4. Click **OK**.

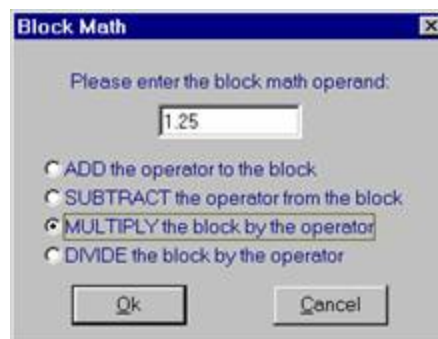

To Cancel or Undo Editing

- To cancel an entry before you press ENTER, press **ESC**.
- To undo a completed entry, click the **Undo**  button.

To Edit Cell Contents

1. Click the cell that contains the data you want to edit.
2. Make any changes to the cell contents.
3. To enter your changes, press **ENTER**.
4. To cancel your changes, press **ESC**.



Note

- To replace the contents of a cell, click on the cell and type the new entry.
- To edit the contents of a cell, double-click on the cell and use the arrow keys to locate the cursor and perform the edit.

Inserting, Deleting and Clearing Cells

To insert cells you must insert an entire row. When you delete cells you must delete an entire row. The row is removed from the worksheet and shifts the lower cells to fill the space. When you clear cells, you remove the cell contents but leave the blank cells on the spreadsheet.

To Insert Rows

1. Click a cell in the row immediately above where you want the new row.
2. To insert a blank line, click the **Insert New Line**  button.
3. To have the values of the current line copied in the new line, click the **Repeat Current Line**  button.

To Clear Cell Contents

1. Select the cells, rows, or columns you want to clear and press the **DELETE** key.

To Delete Rows

1. Select the rows you want to delete.
2. Click the **Delete Marked Lines**  button and the lower cells will shift up to fill the space.

Note

- Some spreadsheets do not allow you to delete lines. For example the Member Design spreadsheet has one line for each member defined. You may leave these lines blank but may not delete them.

Moving and Copying Cell Contents

Standard Windows cut, copy and paste functions are fully supported. By using the clipboard you may move or copy any spreadsheet data to another location in the same spreadsheet, or to another spreadsheet (provided it fits). You may also copy data to or from another model or any other application that supports copy and paste such as a word processor or spreadsheet.

To Move or Copy Cells

1. Select the cells you want to move or copy.
2. To copy the cells select **Copy** on the **Edit Menu**.



To move cells select **Cut** on the **Edit Menu**.

- Click on the cell you wish to place the data in and click the **Paste**  button.

To Move or Copy Cells between Existing Cells

- Select the cells you want to move or copy.
- To copy the cells select **Copy** on the **Edit Menu**.

To move cells select **Cut** on the **Edit Menu**.

- Select a cell on the row above where you want to place the data.
- Click the **Insert New Line**  button for each new line that is needed.
- Click on the upper left cell you wish to place the data in and click the **Paste**  button.

To Move or Copy Cells to Another File

- Select the cells you want to move or copy.
- To copy the cells select **Copy** on the **Edit Menu**.

To move cells select **Cut** on the **Edit Menu**.

- Open the file you wish to copy the data to.
- Click on the cell you wish to place the data in and click the **Paste**  button.

Note:

- Your data stays in the clipboard until you cut or copy new data. You may repeat step 4 to move or copy data to multiple locations.
- When you copy information a dialog will come up asking if you want to copy the spreadsheet headers as well. This is helpful if you are copying information to a spreadsheet-type program. See the [Customizing RISA](#) topic for more information on this.

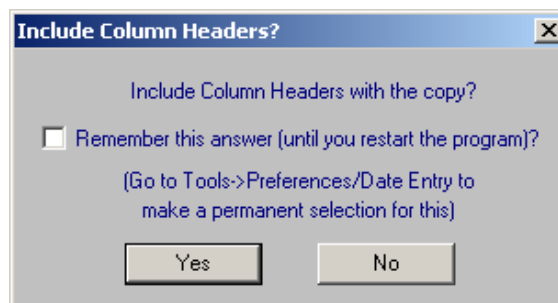

Sorting and Finding in Spreadsheets

You may sort spreadsheets by the values in most any column. Simply click in the column you wish to sort, click on the **Sort**  button and choose the sorting method.



You may relabel the joints, members, plates, or solids after sorting them by using the options in the **Tools Menu**.

To locate or find a specific joint, member, or plate while in a spreadsheet, click the **Find**  button on the **Window Toolbar**.



Default Spreadsheet Data

Many of the spreadsheets provide the option to save the current data as the default and every new file subsequent to the save will already have that data. This way the office standards that you might use in most of your models are already entered and available in new models. This feature is available in the following spreadsheets: **Materials, Design Rules, Footings, and Load Combinations**.

To save default data simply click the **Save as Defaults**  button when you are ready and the current data in the spreadsheet will be used in each new file that you create. The data is saved for the current, active, spreadsheet only and affects no other open or closed spreadsheets.

Special Spreadsheet Functions

There are special functions that help you with a particular spreadsheet. For example you may generate K factors for members on the **Member Design Parameters Spreadsheet**. These features may be accessed on the **Window Toolbar** or you may right click your mouse on the spreadsheet and choose the feature on the **Shortcut Menu**.

Member Design Spreadsheet

Click  to approximate the K factor for the current member or all of the members. See [K Factors](#) (Effective Length Factors) learn more about this feature.

Basic Load Case Spreadsheet

Click  to copy loads from one basic load case to another. You may choose certain load types such as distributed loads and point loads. Once you have created a copy you can use the spreadsheet tools to quickly modify the loads.

Click  to clear loads from a basic load case.

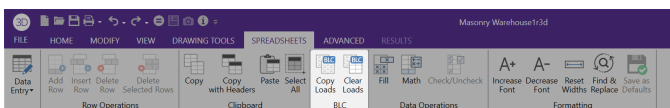

Load Combinations Spreadsheet

Click **Solve Current** , **Solve Batch** or **Solve Envelope** to solve the current load combination, batch, or envelope solutions.

You may click **LC Generator** button to have the program generate load combinations based on a variety of Building Codes. See [Generating Building Code Combinations](#) for more information.

Selecting Items in the Model View

In certain results spreadsheets there is the capability to have elements selected graphically.

The process is as follows:

1. Unselect the entire model.
2. Open the desired results spreadsheet.
3. Highlight in Yellow the lines you wish to view graphically, by clicking on the number of those lines on the far left.
4. Click the **Select Marked Lines in Current View** icon .
5. Only those elements highlighted will be selected graphically.

Note: The inverse process can be used to Unselect Marked Lines using the .

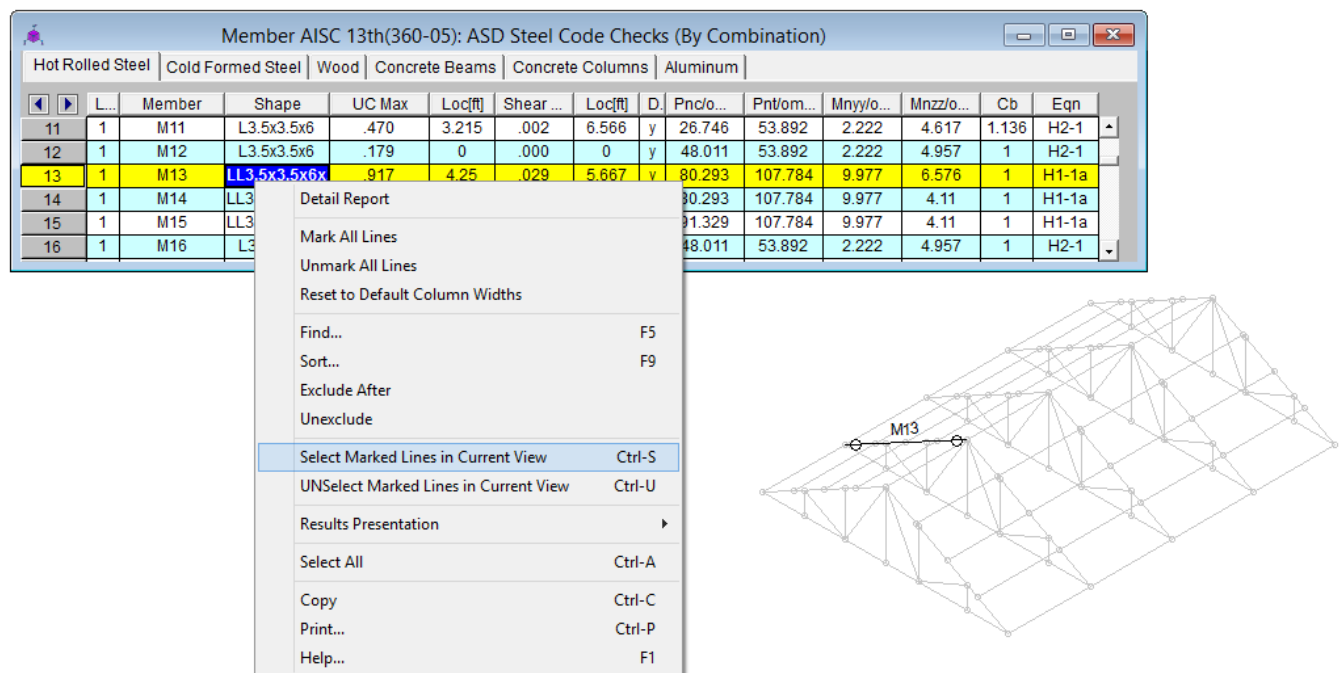

L...	Member	Shape	UC Max	Loc[ft]	Shear ...	Loc[ft]	D	Pnc/o...	Pnt/om...	Mnyy/o...	Mnzz/o...	Cb	Eqn	
11	1	M11	L3.5x3.5x6	.470	3.215	.002	6.566	y	26.746	53.892	2.222	4.617	1.136	H2-1
12	1	M12	L3.5x3.5x6	.179	0	.000	0	y	48.011	53.892	2.222	4.957	1	H2-1
13	1	M13	L3.5x3.5x6x	.917	4.25	.029	5.667	v	80.293	107.784	9.977	6.576	1	H1-1a
14	1	M14	LL3						80.293	107.784	9.977	4.11	1	H1-1a
15	1	M15	LL3						91.329	107.784	9.977	4.11	1	H1-1a
16	1	M16	L3						48.011	53.892	2.222	4.957	1	H2-1

Stability

Instabilities occur whenever a joint can deflect or rotate without limit. Put another way; **a joint is unstable if there is nothing to restrain it.**

With that one statement you can understand and resolve any instability problem. Instabilities are easy to understand and easy to fix. The next section explains what RISA-2D does with instabilities. The following sections provide some simple examples of instabilities and their resolution.

For additional advice on this topic, please see the RISA Tips & Tricks webpage at risa.com/post/support. Type in Search keywords: **Instabilities**.

Instability Procedure

Because many instabilities are inconsequential to the results yet they prevent a solution RISA-2D locks them as they are discovered and proceeds with the solution. This locking is a boundary condition that removes the degree of freedom from the solution. A reaction (if any) is not calculated and that is one of the dangers of ignoring instabilities. See [Testing Instabilities](#) to learn how to test if an instability is affecting the results.

At the end of the solution you will be notified that joints have been locked and that you may view the affected joints in a model view. These locks will also be reported in the **Reactions** spreadsheet.

Note

- Isolated rotational instabilities do not produce a notification that joints have been locked. You may adjust this in the **Output** section of the **Application Settings** on the **Tools** menu if you wish to be warned about all instabilities.

Instability Causes

Common causes of instabilities are briefly mentioned here and then highlighted in the examples below.

Member End Releases – Boundary Conditions

Overuse of member end releases and/or boundary conditions is by far the most common cause of instability as shown in the examples below. The solution is to either remove a member end release or change a boundary condition so that the joint is restrained. **At least one member or boundary needs to be fixed to each joint to prevent instability.** If you think of a joint as the end of a member and specify no release for that member end this member still will not experience moment at the end if all other elements are left unfixed.

Unconnected Elements

Joints that are not connected into the model cause instabilities. This is much more common in models without Physical Members as can be seen below. The solution may be to merge the model with the model merge feature.

Flexible Elements

Members or plates with relatively small properties such as a long member with a moment of inertia of 1.0 in^4 can cause instabilities. This is usually not a problem unless the members are not used properly.

Instability Examples

These simple examples are provided to directly address the common scenarios that occur in structural modeling. You will notice a recurring theme so once you understand one or two of them you will have a handle on the causes and resolutions for most instabilities, including those in more complex models.

Remember the golden rule as you look at each example: **A joint is unstable if there is nothing to restrain it.**

Cantilever Beam/Column

If a member end release is specified at the free end of a cantilever the joint becomes unstable because it is free to rotate without any resistance.

Cause: Specifying a member release at the free end of a cantilever member.

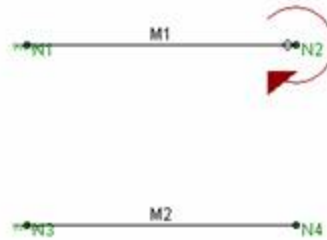

Resolution: Remove the member end release.

If the member is not released from the joint then the member provides resistance to the joint so that it cannot rotate without limit. The member end moves and rotates and the joint goes along for the ride. There will be no moment at the free end of the member since there is nothing there to pass moment.

Column at a Support

If a pinned column base is modeled with a pinned boundary condition **AND** a member end release at the base of the column the joint becomes unstable because it is free to rotate without any resistance.

Cause: Specifying a pinned boundary condition **AND** a member release.

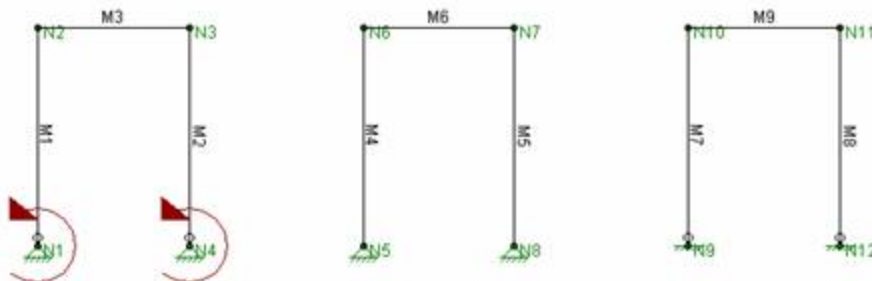

Resolution: Either remove the member end release or specify a fixed boundary condition. Do not do both unless you want a fixed column base that resists moment.

If the member is not released from the joint then the member provides resistance to the joint so that it cannot rotate without limit. The member end rotates and the joint goes along for the ride. There will be no moment at the base of the member since the pinned boundary cannot resist moment.

If instead the boundary is specified as fixed then the boundary provides resistance to the joint so that it cannot rotate. The member end release allows it to rotate while the joint does not. There will be no moment at the base of the member since the fixed boundary cannot pass moment through the member end release.

Simply Supported Beam

If a pinned beam end is modeled with a pinned boundary condition **AND** a member end release the joint becomes unstable because it is free to rotate without any resistance.

Cause: Specifying a pinned boundary condition **AND** a member release.

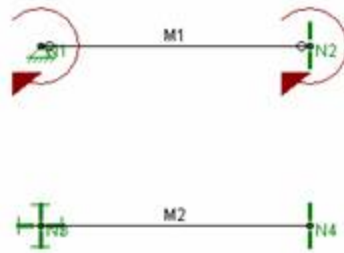

Resolution: Either remove the member end release or specify a fixed boundary condition. Do not do both unless you want a fixed member end that resists moment.

If the member is not released from the joint then the member provides resistance to the joint so that it cannot rotate without limit. The member end rotates and the joint goes along for the ride. There will be no moment at the end of the member since the pinned boundary cannot resist moment.

If instead the boundary is specified as fixed then the boundary provides resistance to the joint so that it cannot rotate. The member end release allows it to rotate while the joint does not. There will be no moment at the end of the member since the fixed boundary cannot pass moment through the member end release.

Beam-Column Connection

If a pinned beam/column connection is modeled with a released column end **AND** a released beam end the joint becomes unstable because it is free to rotate without any resistance.

Cause: Specifying a released column end **AND** a released beam end.

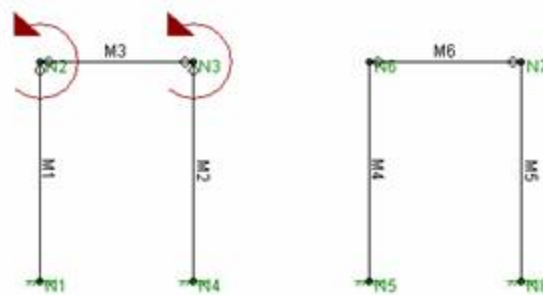

Resolution: Either remove the column end release or the beam end release. Do not do both unless you want a fixed connection that resists moment.

If the column is not released from the joint then the column provides resistance to the joint so that it cannot rotate without limit. There will be no moment at the connection since the beam end release cannot pass moment.

Simple Truss

If a truss panel point is modeled with releases at the ends of EVERY member connecting to that point the joint becomes unstable because it is free to rotate without any resistance.

Cause: Specifying all members with released ends.

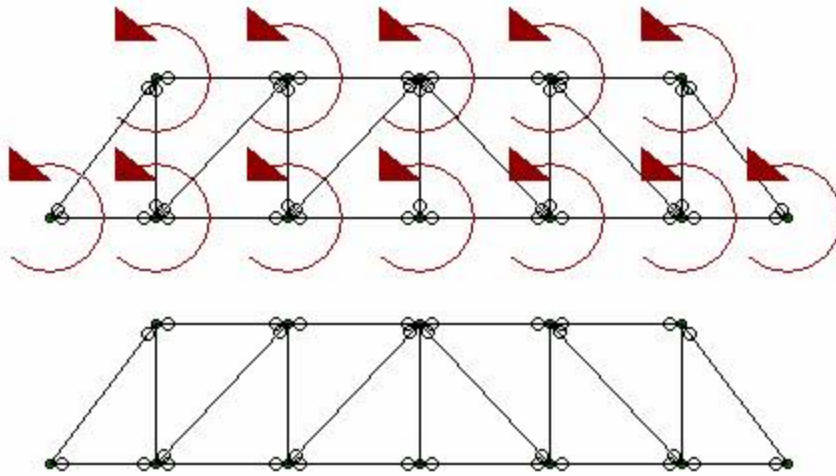

Resolution: Either remove one end release or add a rotational boundary condition at each joint. Do not do both.

If one member end is not released from each joint then the member provides resistance to the joint so that it cannot rotate without limit. There will be no moment at the member end since the remaining members have end releases and cannot pass moment.

You may also solve the problem with a rotational boundary condition at each joint. Using the ALL code you can restrain each joint for rotation and proceed to use end releases at all members.

Unconnected Elements

If a joint, member or plate is not connected to the model then there will be instability. With the use of Physical Members this is rare in a model that only consists of beam elements however those that have plates or finite members can be defined in a way that they are not connected.

Cause: Unconnected elements. The portal frame is not connected to the plate elements because the bottoms of the columns do not fall on plate corners. The plates are stable however the portal frame is not.

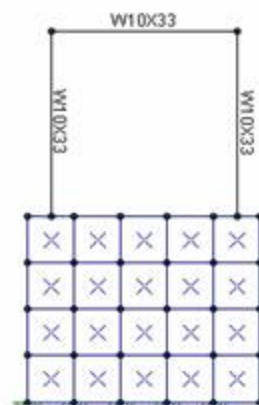

Resolution: For beam models, run the [Model Merge](#) feature. For plate models redefine the mesh so that plates are connected at their corners. Model merge will not solve problems caused by lack of plate continuity.

Testing Instabilities

Although some can be ignored, keep in mind that not all instabilities are necessarily inconsequential. Look at the following model:

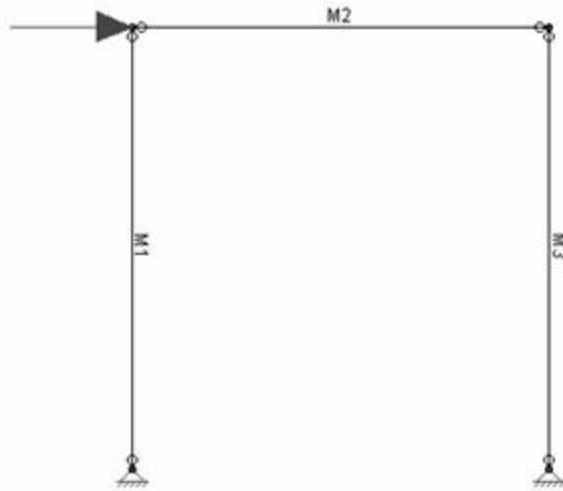

This is an example of a single bent frame that is laterally unstable. To obtain a solution the lateral direction would be locked and a solution obtained, though not a correct one. The warning message may be annoying if you know the instabilities being locked are of no consequence, but there won't be any surprises.

The best way to test whether an instability is inconsequential or not is to apply a Reaction to the joint in the unstable degree of freedom. Then re-run the model and examine the reactions. If the Reaction that is restraining the instability is showing a non-zero force or moment, then you have a problem with the model that must be corrected for you to get valid results. If the Reaction that is restraining the instability is showing a *ZERO* force or moment, then the instability is inconsequential to the results.

Unbraced Lengths

The member capacity for axial compression and for flexure is dependent on the spacing of elements which provide bracing along the length of a member. By default the program assumes that no bracing is provided along the length of the [Physical Member](#). This is represented by the condition where the unbraced length field is shown as empty/blank.

Note

- If bracing is not provided at each end of the physical member then the assumption that the unbraced length equals the physical member length can be unconservative. The program allows you to specify an unbraced length greater than the physical member length to address this situation.

You may specify unbraced lengths as a fixed distance or by using RISA's [Unbraced Length Commands](#). The unbraced lengths are:

- **Lbout**
- **Lbin**
- **Lcomp-top**
- **Lcomp-bot**
- **L-torque**

The unbraced lengths that are used for member capacity calculations are listed in the **Member Detail** report after solution.

Note:

- Specifying bracing via unbraced lengths does not provide physical bracing to the model for analysis. It only affects the member capacity calculated for code checks. See the example below.



Hot Rolled Steel Design Parameters								
Primary	Advanced	Hot Rolled	Cold Formed	Wood	Concrete Beam	Concrete Column	Aluminum	RISAC
	Label	Shape	Length[ft]	Lbyy[ft]	Lbzz[ft]	Lcomp top[ft]	Lcomp bot[ft]	L-torque[ft]
1	M1	W8X10	12	Segment	6			

For compression capacity, M1 (above) is braced at N3 based on specified Lbyy and Lbzz

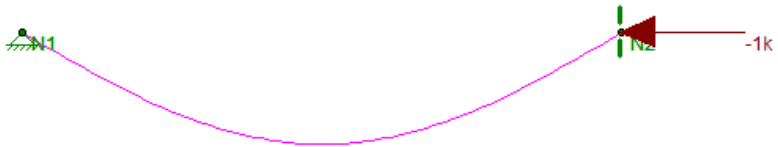

However, for analysis this member is not considered braced (see above)

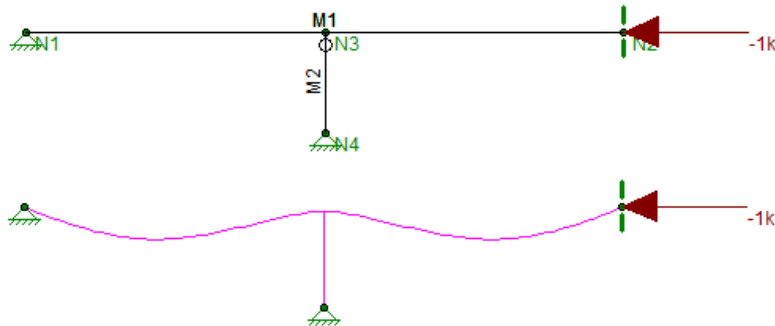

A bracing member (M2) must be modeled to provide bracing for analysis

Lb Values (Lb, Lu, Le)

The **Lb** values: **Lb-out** and **Lb-in**, represent the distance between points which brace the member against Flexural (column-type) Buckling out of plane and in plane, respectively. **Lb** bracing prevents the entire member from moving laterally (perpendicular to its own axis). These **Lb** values are used to calculate slenderness ratios (KL/r) for both directions, which are used in the calculation of member axial compression capacity.

Lcomp Values (Lcomp, Le-bend)

The **Lcomp** values, **Lcomp-top** and **Lcomp-bot**, represent the distance between points which brace the top or bottom flange of the member against Lateral-Torsional (beam-type) Buckling. These **Lcomp** values are used to calculate the member's flexural (bending) capacity. Where the top flange of the member is in compression due to bending, **Lcomp-top** is used. Where the bottom flange of the member is in compression due to bending, **Lcomp-bot** is used. **Lcomp** bracing prevents the member's flange from moving laterally (perpendicular to the member's axis).

Members which experience a moment reversal along their length (such as fixed-end or continuous members) have compression in both the top and bottom flange (although not simultaneously). The program uses the appropriate **Lcomp** (top or bottom) based on moment direction to calculate the bending capacity at each [internal section](#) along the member.

The top flange is the flange on the positive local y-axis side of the member. Therefore if a beam is rotated 180 degrees about its own axis (flipped upside down) the "top" flange will actually be facing downwards.

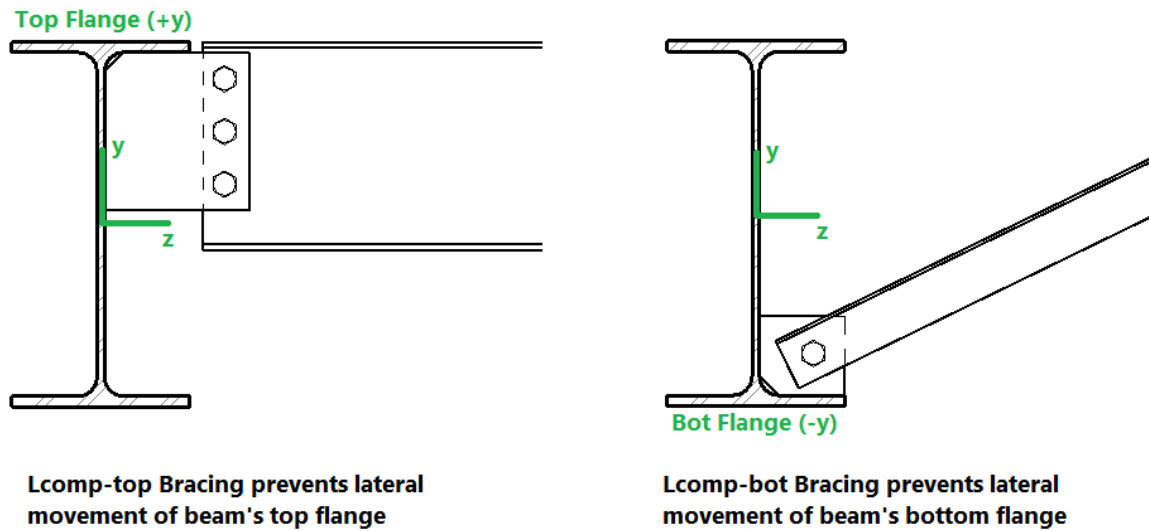

Note:

- Concrete members are not checked for lateral-torsional buckling, so **L_{comp}** is not used for concrete.

L-torque

The **L-torque** value represents the distance between points which restrain the member against twisting about its own axis. This value is used to calculate the member's Torsional Buckling and Flexural-Torsional Buckling capacity. These limit states affect the member's axial compression capacity.

L-torque always defaults to the full member length and cannot be changed by the user.

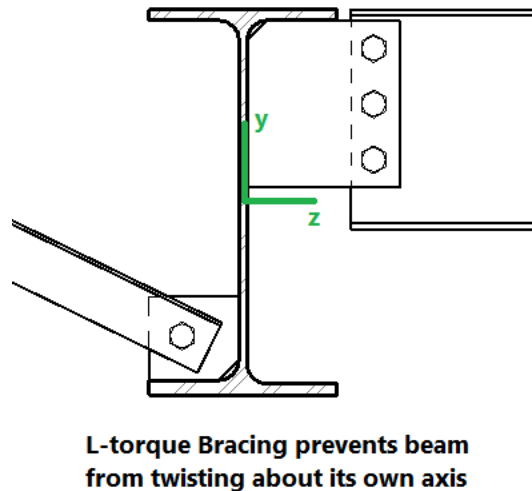

Note:

- Not all design codes check for Torsional Buckling or Flexural-Torsional Buckling. For those that do, these limit states will only be checked if **L-torque** > **L_{b-in}** and **L_{b-out}**.
- Currently the AISC 360 code, CSA S16-14 code, Aluminum codes, and the 2010 and newer Cold Formed Steel codes support this unbraced length.

Automated Unbraced Length Commands

Aside from leaving the unbraced length blank or inputting a fixed distance, you can harness the program's ability to use a limited intelligence for determining unbraced lengths. In order to do this you can simply type in the name of the Unbraced Length Commands into the unbraced length field. If a valid command word is used then the program will accept and display that command in lieu of a distance value.

	Label	Shape	Length...	Lb-out[ft]	Lb-in[ft]	Lcomp top...	Lcomp bot...	K-out	K-in	Cb	Func...
1	M2	W12x40	12	Segment 1		Lbyy					Lateral
2	M3	W12x26	15			0					Lateral
3	M4	W12x40	12			Lbyy					Lateral
4	M5	W16x67	30			0					Lateral
5	M9	HSS4.5x4.5x4	19.209			Lbyy					Lateral
6	M10	HSS4x4x4	19.209			Lbyy					Lateral
7	M12	LL5x3.5x4x3	19.209			Lbyy					Lateral

Some member types are pre-populated with an Unbraced Length Command when they are created. Below is a list of the commands which may be used:

Segment

When this command is used, all Joints which fall along the length of the physical member are assumed to provide bracing. If Joints are not evenly spaced along the member then an unbraced length is calculated for each "segment". A segment is defined as the distance between adjacent Joints. In the example below, the member is defined as one physical member spanning from N1 to N2. The intermediate node N3 is considered as a brace point when Segment is specified for this member. Therefore the forces which occur in Segment 1 will be compared against a capacity calculated using Lb_1 , and the forces occurring in Segment 2 will be compared against a capacity calculated using Lb_2 .

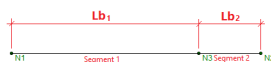

When using the Segment command the program will assume that each node along the length of the member can act as a brace location regardless of whether any bracing or restraint exists. In the example above this will result in an unconservative member capacity if no bracing will be supplied at N3 in real life.

Lb out

This command is only available for Lcomp-top and Lcomp-bot. When this command is used, the value entered for Lb out will also be used for Lcomp.

Information for Member M28

General | End Releases | Properties | Design

Unbraced Lengths

Lb out ft

Lb in ft

Lcomp top ft

Lcomp bot ft

Material Specific Behavior

Hot Rolled Steel

- For AISC ASD 9th Edition calculation of Kl/r for WTs and Double Angles, there is an effective Kl/r ratio that may be used when Flexural-Torsional buckling controls. This can be found in the commentary Section E3.
- Specifying $L_{compTop}$ and $L_{compBot}$ both as zero constrains a single angle to bend/buckle about its geometric axes. Otherwise it will behave about its principal axes. See [Member Results](#) for more information on Single Angle behavior.
- For single angles behaving about their principal axes, L_{byy} specifies bracing against buckling about the minor principal axis. L_{bzz} specifies bracing against buckling about the major principal axis. See [Member Results](#) for more information on Single Angle behavior.

Cold Formed Steel

In general, the unbraced lengths for Cold Formed bending checks are based on the **Lcomp** value and axial checks are based on **Lb** values. Below describes more specifics based on the AISI 2012 code.

Lateral Torsional Buckling (AISI C3.1.2)

$L_t = L_{comp}$

L_{comp} is the unbraced length for the flange that's in bending compression at that section (either L_{comp_top} or L_{comp_bot}).

This applies to all shapes and all AISI codes.

Note: Older Versions of RISA-3D (v12 and older)

$L_t = \text{smaller of } L_{byy} \text{ and } L_{comp}$

When Lateral Torsional Buckling governs over local buckling, the display of the S_{eff} in the Detail Report will report the S_c which is the elastic section modulus of effective section calculate relative to the extreme compression fiber at F_c .

Distortional Buckling (AISI C3.1.4)

$L_m = L_{comp}$

L_{comp} is the unbraced length for the flange that's in bending compression at that section (either L_{comp_top} or L_{comp_bot}).

Axial Strength (AISI C4.1)

$L = \text{Could be } L_{byy} \text{ or } L_{bzz}, \text{ whichever gives the larger of } (KL/r)_{yy} \text{ or } (KL/r)_{zz}$

Flexural Torsional Buckling or Torsional Buckling (AISI C4.1.2)

$L_t = L\text{-Torque}$

Note: Older Versions of RISA-3D (v12 and older)

$L_t = \text{smaller of } L_{byy} \text{ and } L_{comp}$

Distortional Buckling (AISI C4.2)

$L_m = L\text{-Torque}$

- The Torsional Warping constant for Back-to-Back Channels and Tracks, C_w is calculated per the AISI prescribed doubly symmetric shapes (AISI-08 Manual 3.3.3) that are continuously welded (all the unbraced lengths are 0). If the Back-to-Back shape is not continuously welded (any of the unbraced lengths larger than zero), C_w is twice the value of each individual section.

- For Hat Channel (HU) shape types, the **Lcomp-top** and **Lcomp-bot** values only apply to the flanges perpendicular to the local y axis (see image below). Therefore, if your loading is applied in the local z direction, these entries will not apply. This assumption was made in reference to section C3.1.2.1 of the *AISI Specification with Commentary* whose footnote tells us that the limit state of Lateral-Torsional Buckling does not apply to these shapes.

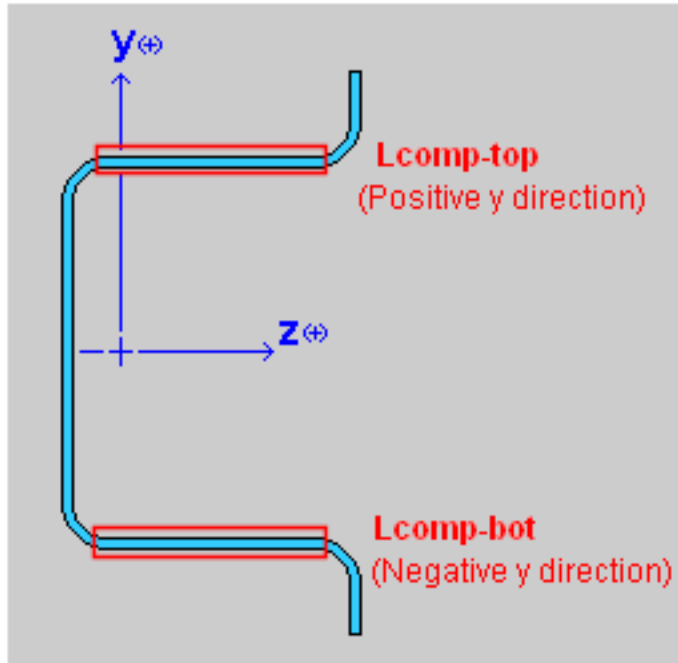

Concrete

- The unbraced lengths for Flexural Buckling (Lb-out, Lb-in) are called Lu-out and Lu-in for concrete. Their behavior is the same as the behavior for Lb-out and Lb-in.
- The unbraced lengths are used for the [Moment Magnification](#) procedure in older versions of the ACI code.

Wood

- The unbraced lengths for Flexural Buckling (Lb-in, Lb-out) are called Le-in and Le-out for wood. Their behavior is the same as the behavior for Lb-out and Lb-in.

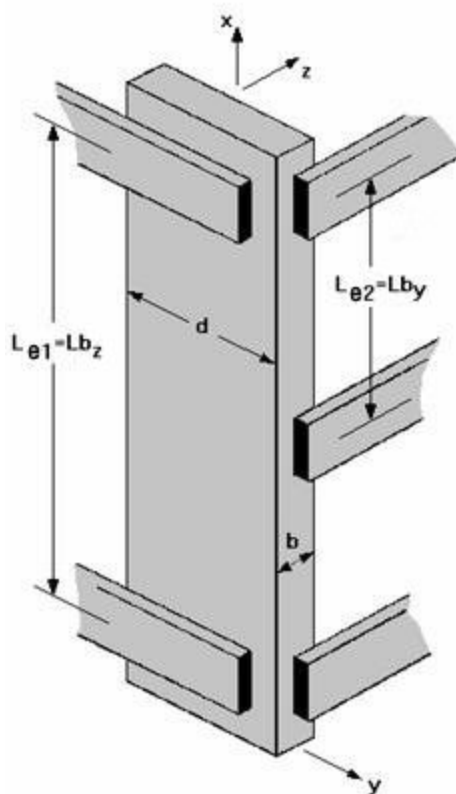

- The unbraced lengths for Lateral-Torsional buckling ($L_{comp-top}$, $L_{comp-bot}$) are called $L_{e-bend Top}$ and $L_{e-bend Bot}$ for wood. Their behavior is the same as the behavior for $L_{comp-top}$ and $L_{comp-bot}$.
- See AF&PA NDS-2012, Table 3.3.3 for information on how to determine L_{e-bend} based on the unbraced length. This procedure is not followed automatically in RISA.

Aluminum

- Specifying $L_{compTop}$ and $L_{compBot}$ both as zero constrains a single angle to bend/buckle about its geometric axes. Otherwise it will behave about its principal axes. See [Member Results](#) for more information on Single Angle behavior.
- For single angles behaving about their principal axes, L_{by} specifies bracing against buckling about the minor principal axis. L_{bz} specifies bracing against buckling about the major principal axis. See [Member Results](#) for more information on Single Angle behavior.

For additional advice on this topic, please see the RISA Tips & Tricks website: www.risa.com/post/support. Type in Search keywords: **Unbraced Lengths**.

K Factors (Effective Length Factors)

Effective Length Factors (K) are recommended or required for some design codes. The effective length factor allows you to adjust the unbraced length for Flexural Buckling as a simplified method of accounting for buckling effects. **K-out** is a modifier factor for [Lbout](#). **K-in** is a modifier factor for [Lbin](#).

If the K Factor field is left blank/empty then it is taken as 1.0, thereby not affecting the unbraced length.

If a value is entered for a **K Factor**, that value will be used for the entire length of the physical member. If an entry is not made (left blank), the value will internally default to '1' for that member.

Note

- **K-torque** for Torsional or Flexural-Torsional Buckling is always be assumed to be 1.0, except for Aluminum design where it is taken as the lesser of K_{yy} or K_{zz} .

***K* Approximation Feature**

RISA-2D is able to approximate the recommended K values for a member based on the member's sway condition and end release configuration. The K-factor approximation is based on AISC 360-10, Table C-A-7.1. To access this feature you must be in the Members spreadsheet, on the tab which shows the unbraced lengths. Click the **Calculate Approximate K Values**  button on the toolbar or right-click in the spreadsheet and choose **Approximate K**.

The following table gives the values the program calculates for various conditions.

Table Case	End Conditions	Sidesway?	K-Value
(a)	Fixed-Fixed	No	.65
(b)	Fixed-Pinned	No	.80
(c)	Fixed-Fixed	Yes	1.2
(d)	Pinned-Pinned	No	1.0
(e)	Fixed-Free	Yes	2.1
(f)	Pinned-Fixed	Yes	2.0

RISA-2D recognizes a pinned boundary condition for the K approximation for a full pin, i.e. if all the rotations in the boundary condition are released. If any of the rotations in a boundary condition are restrained, the boundary condition is considered "fixed" for the K factor approximation.

Any configuration not described here is given the default value of '1.0'.

If any value that influences these K values is changed, the K factor approximation should be redone. For instance, if you have RISA-2D approximate K factors, then change some of the member end release designations, you should redo the K factor approximations.

Remember that the K factors are *approximations* and you should check to make sure you agree with all K factors RISA-2D assigns. You can always override a K factor after an approximation by directly entering the value that you want in the appropriate field. Keep in mind that a subsequent approximation will overwrite any manually input values so you will need to override the approximation each time it is performed.

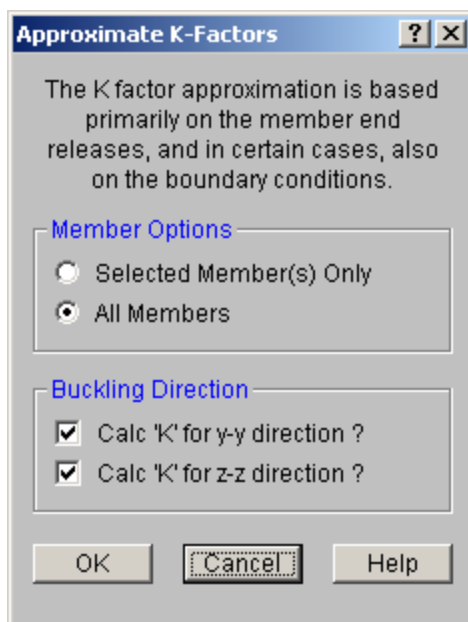
**Limitation:**

RISA-2D will currently neglect the influence of adjoining framing members when those members are connected at a joint that also has degrees of freedom restrained by boundary conditions. For example, suppose a column and beam member connect at a joint that is restrained for translation in both directions (i.e. the joint is "pinned"). The K factor approximation will neglect the beam member when it calculates the K factor for the column and visa-versa. The effect will be that the ends of the members at that joint will be seen as "pinned" and not "fixed" for the K factor approximation.

Sway Flags

The **Sway Flags** indicate whether the member is to be considered subject to sidesway for bending in and out of plane. The **Out sway** field is for out of plane bending and the **In sway** field is for in plane bending. Click on the field to check the box and indicate that the member is subject to sway for that particular direction, or leave the entry blank if the member is braced against sway. These sway flags influence the calculation of the K factors as well as the C_m and C_b factors.

Units

You can work with imperial (kips, inches, etc.) or metric (KN, meters, etc.) units, or any combination of the two. The current units appropriate for each data item are shown at the tops of the data columns in the spreadsheets and with the plot of values in the model view.

You may save any of the units as the default setting so that when you start a new model that information is already there. To do this, simply enter the information that you want to save and check the **Save as Defaults** box and click **OK**.

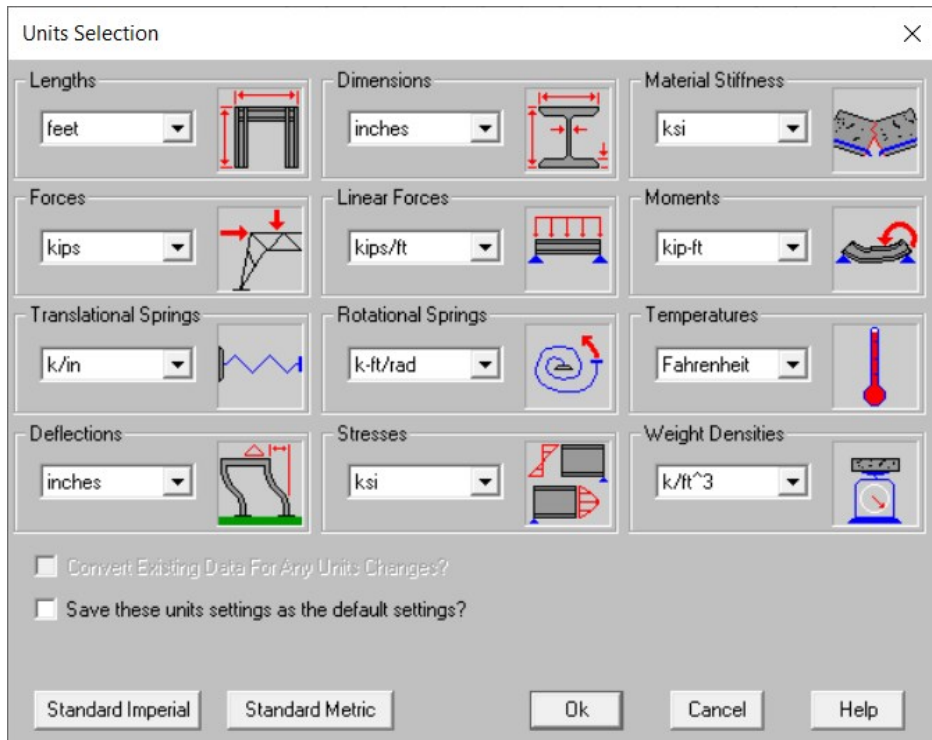

To Change Units

Standard units systems are preset and may be specified by clicking the **Standard Imperial** and **Standard Metric** buttons.

3. If you do not wish to convert values already entered then clear the check box for **Converting Existing Data**.

Standard Imperial Units

This is the units system currently prevalent in the United States. 'Feet' are used for location entries such as joint coordinates and load locations, and 'Inches' are used for section property entries such as area and moment of inertia. Force and weight units are in 'kips', where 1 kip = 1000 pounds. Stress units are in 'ksi' (kips per square inch).

Standard Metric Units

This units system uses 'Meters' for location entries and 'Centimeters' for section property entries. Force units are in 'kN' (kiloNewtons), where 1 KN = 1000 Newtons. Stress units are in 'MegaPascals' (MPa), where a MegaPascal is 1,000,000 Newtons per square meter. Weight units are in 'Kilograms' and thermal units are in 'Degrees centigrade'.

Units Specifications

The following are the unit specifications and their applications:

Measurement	Usage
Lengths	Coordinates, Unbraced Lengths, Load Locations
Dimensions	Shape Properties, Plate Thickness, Member Offsets
Material Stiffness	E, G
Weight Densities	Material Density
Forces	Loads, Forces
Linear Forces	Distributed Loads
Moments	Loads, Forces
Area Loads	Area Loads
Translational Springs	X Y Z Boundary Conditions
Rotational Springs	X Rot, Y Rot, Z Rot Boundary Conditions
Temperatures	Thermal Coefficient, Temperatures
Deflections	Deflections, Displacements
Stresses	Fy, Allowable and Actual Stresses

Wall Panels

The wall panel element allows you to easily model walls for in plane loads. Wall panel data may be viewed and edited in two ways: graphically in the [Wall Panel Editor](#) or in the [Wall Panels Spreadsheet](#).

Drawing Wall Panels

There are several graphic-editing features that make the creation and modification of models quite easy. Use the Insert and Modify menus or the Drawing Toolbar to use these features in the model view. To create new wall panels, you can draw them using a drawing grid or draw "dot to dot" existing joints. Once you have created these items you may use other graphic features to apply loads and set boundary conditions.

You can set many of the wall panel properties up front or you can modify these properties after you draw them. Modifying properties is discussed in the next sections. See the [Wall Panels](#) topic for information on wall panels and their properties.

The **Draw Wall Panels**  button lets you graphically draw wall panels in your model. Enter the appropriate wall panel parameters, click **OK** and draw wall panels between existing joints or on the drawing grid. You will also notice that the coordinates of the joint or grid point that is closest to your cursor are displayed in the lower right hand corner of the model view. The new wall panels will be shown on screen and will be recorded in the **Wall Panels Spreadsheet**.

To actually draw a wall panel, you have two options. One way is to modify your Drawing Grid according to how you wish to lay out your wall panels and use the **Create Wall Panels by Clicking on Grid Areas** option. Wall panels can then be created by clicking in the grid areas formed by the intersecting grid lines. As you click on an area, a wall panel will automatically be created in that area. The second option is to create wall panels by drawing them one joint at a time. First click on the grid point or joint that you want to be the "A" joint for the plate, then the "B" joint, "C" joint, and "D" joint in either clockwise or counter-clockwise order. The wall panel will "stretch" like a rubber band as you draw from joint to joint.

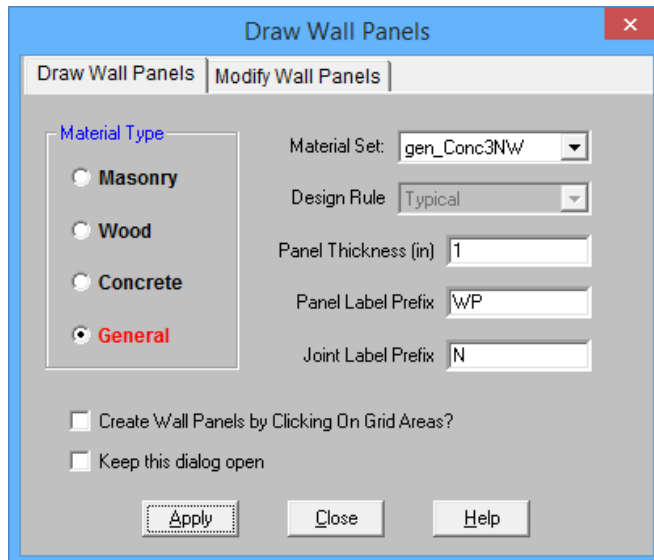

Note:

- You must draw wall panels rectangular.



The parameters shown are the same parameters that you would enter on the [Wall Panels Spreadsheet](#).

To Draw Wall Panels

1. If there is not a model view already open then click  on the **RISA Toolbar** to open a new view and click  to turn on the **Drawing Toolbar** if it is not already displayed.
2. If you are not drawing between existing joints, you will need to create a drawing grid or define joints on the **Joint Coordinates** spreadsheet.
3. Click the **Draw / Modify Wall Panels**  button and select the **Draw Wall Panels** tab. Then set the wall panel properties.
4. Click **Apply** to start drawing wall panels by clicking on the joints or grid points with the left mouse button.
 1. You must click four points in a clockwise or counter-clockwise order.
 2. Or, click in grid areas.
5. To stop drawing altogether right click or press the **Esc** key.

Note

- To draw more wall panels with different properties, press CTRL-D to recall the **Wall Panel Properties** settings.
- You may also specify or edit wall panels in the [Wall Panels Spreadsheet](#).
- You may also view and edit wall panel properties by double-clicking on a wall panel.
- You may undo any mistakes by clicking the Undo  button.
- Drawing clockwise or counter-clockwise determines the panel's local axes directions. See [Wall Panel Local Axis](#) for more information.

Modifying Wall Panels

There are a number of ways to modify wall panels. You may view and edit the member data in the **Wall Panel Spreadsheet**, you may double-click a wall panel to view and edit its properties, or you can use the **Modify Wall Panels** tool to graphically modify panels.

The graphical **Wall Panel Modify** tool modifies the properties of wall panels that already exist in the model. To use this tool, specify the properties you want to change and then select the wall panels that you want to apply these changes to. Wall panels can be modified one-at-a-time by selecting the **Apply Entries by Clicking** option. This will change the mouse cursor to a modify tool which applies to any wall panels which you click on. A group of selected wall panels can be modified all at once by using the **Apply Entries to All Selected** option. See the [Graphic Selection](#) topic for more on selecting.

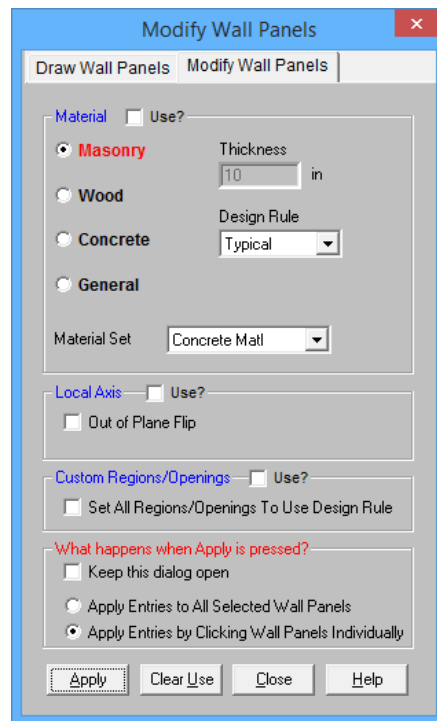

The **Out of Plane Flip** option will flip the openings and regions within the wall. If you draw in your openings opposite of what you meant then this tool can be useful.

The parameters shown are the same as those used to define new wall panels.



The **Use?** check boxes next to the data fields indicate whether the particular parameter will be used or not when the modification is applied. If the box next to a field is checked, that parameter will be applied to any selected wall panels. If the box is NOT checked, the parameter will NOT be applied, even if a value is entered in the field. This allows you to easily change one or two properties on wall panels without affecting all the rest of the properties. Note that if a no value is entered in a field (i.e. the field is blank) and the corresponding check box is checked, clicking “Apply” will have the effect of clearing the data for that field.

To Modify Wall Panels

1. If there is not a model view already open then click  on the **RISA Toolbar** to open a new view and click  to turn on the **Drawing Toolbar** if it is not already displayed.
2. Click the **Draw / Modify Wall Panels**  button and select the **Modify Wall Panels** tab. Then set the parameters for the new wall panels. Check the **Use?** Box for the items to apply.
3. You may choose to modify a single wall panel at a time or to an entire selection of wall panels.
 1. To modify a few wall panels choose **Apply Entry by Clicking Items Individually** and click **Apply**. Click on the wall panels with the left mouse button.
 2. To modify a selection of wall panels, choose **Apply Entries to All Selected Items** and click **Apply**.

Note

- To modify more wall panels with different parameters, press CTRL-D to recall the **Modify Wall Panels** settings.
- You may also modify wall panels in the [Wall Panels Spreadsheet](#).
- You may undo any mistakes by clicking the **Undo**  button.
- The thickness option is only available if you are choosing a General or Concrete material. Wood and Masonry require you to change their thickness in the [Design Rules](#) spreadsheet.

- For existing models of version or earlier, all wall panels will be brought in using **Custom** regions/openings. Here we provide an option that will reset all wall panels to base their design on the Wall Design Rule.

Wall Panel Spreadsheets

Another way of editing wall panels is through the **Wall Panel Spreadsheet**. This spreadsheet is accessible through the **Data Entry Toolbar** and includes data on two tabs: Primary and Advanced.

	Label	A Joint	B Joint	C Joint	D Joint	Material Type	Material Set	Thickness[in]	Design Rule	Panel/Spacing
1	WP1	N1	N2	N3	N4	Masonry	Concrete Matl	10	Typical	72
2	WP2	N5	N6	N7	N8	Wood	DF	5.5 (stud)	Typical	S1_3/8_8d@6 16
3	WP3	N9	N10	N11	N12	Concrete	Conc3000NW	12	Typical	N/A
4	WP4	N13	N14	N15	N16	Concrete	Conc3000NW	12	Second Floor	N/A
5	WP5	N17	N18	N19	N20	General	gen_Conc3NW	12	Typical	N/A

	Label	Seismic Rule	Design Method	SSAF	In-plane Ic...	K	Cm
1	WP1	N/A	N/A	N/A			No Val
2	WP2	None	N/A	N/A			
3	WP3	N/A	Force Transfer	1	N/A		No Val

The following data columns hold the primary data for the wall panels:

Wall Panel Labels

You may assign a unique label to any or all of the wall panels. You can then refer to the wall panel by its label. Each label has to be unique, so if you try to enter the same label more than once you will get an error message. You may relabel wall panels at any time with the Relabel Wall Panels option on the Tools menu.

Wall Panel Joints

The A, B, C, and D joint entries are used to define the 4 corner joints of a wall panel. The joints must all lie on the same plane, be oriented parallel to the vertical axis and be entered in either a clockwise or counter-clockwise sequence. They can not be adjusted from the spreadsheet.

Wall Panel Material Type and Material Set

The material set label links the wall panel with the desired material defined on the [Material Spreadsheet](#).

Note

- Currently wall panels can only be made up of concrete, masonry, wood, or general materials.

Wall Panel Thickness

The thickness field on the Wall Panels Spreadsheet is the thickness of the element. This thickness is constant over the entire element. Note that the thickness for Masonry and Wood wall panels are set in the [Design Rules](#) spreadsheet. For concrete and general material walls the value is defined here.

Design Rule

This allows you to choose a specific design rule from the Design Rules spreadsheet. The design rule is where you can specify very detailed information for the wall.

Panel/Spacing

This shows the current panel for masonry and wood walls. Wood and masonry walls can require an iterative solution. This means that the panel properties used for a wall panel may change from solution to solution, so here is the place where that information is displayed. Note that the panel properties also show up in the output.

When you select a design rule for a wall panel, there may be a range of sheathing call-outs, stud spacings and bar/grout spacings. At the initial solution the program simply uses the first item in the list that meets the criteria of the design rule and then the optimization starts from there. This initial criteria is what will show up in the **Panel/Spacing** column. After you optimize your wall this panel criteria may update/change. If you want to reset all of these values to the original values, simply press the **R** button when in the **Wall Panels** spreadsheet.

Note:

- For masonry walls we show the current bar/grout spacing.
- For wood walls we show the current sheathing call-out and the current stud spacing.
- For concrete walls this column is not applicable, as the stiffness of the wall is not affected by the program optimization.

Design Method

This is a column specific to wood wall panels and allows you to choose which design method you choose to work with: Segmented, Perforated or Force Transfer. See the [Wood Wall Panels](#) topic for more information. These design methods are not applicable for concrete, masonry, or general wall panels.

Note:

- Currently, wood wall panel design is only available for NDS design.

SSAF (Shear Stiffness Adjustment Factor)

This is a factor specific to wood wall panels that allows the user to manually adjust the shear stiffness of a particular wall panel. Because the program uses a finite element solution the program does not automatically consider some contributions to the FEM deflections, such as nail slip. With this adjustment factor the user can match up the deflections from their hand calculations with the FEM joint deflections at the top nodes in the wall.

Icr

These values are considered for both masonry and concrete wall design and allow you to modify the stiffness of the wall for cracking considerations. This value will be multiplied by the Igross of the wall.

Masonry Walls

By default (if left blank) the program will use a value of 0.50. This value comes from Section 3.1.5.2 of the ACI 530-11 code. If you have performed a cracked section analysis or want to override this default you can input it directly here.

Concrete Walls

By default (if left blank) the program will use a value of 0.70. This is the minimum factor for beams per ACI 318-14 Section 6.6.3.1.1 (ACI 318-11 Section 10.10.4.1). If you have performed a cracked section analysis or want to

override this default you can input it directly here.

For service level analysis, the level of cracking will be significantly less. Therefore, the stiffness used in your analysis should be representative of the reduced loading and reduced cracking. Per the ACI 318-14 Section R6.6.3.2.2 (ACI 318-11 Section R10.10.4.1), the program will account for this increased stiffness by applying a factor of 1.43 to the cracked section properties for any load combination that has the “**Service Load**” flag checked on the **Design** tab of the **Load Combinations Spreadsheet**

Note:

- This factor will only be used if the **Use Cracked Sections** checkbox is checked in the Concrete tab of [Model Settings](#).
- This factor (or $1.43 \cdot I_{cr}$) can not be greater than 1.0.

K Factor

This is the effective length factor and is available concrete, masonry and wood walls. If left blank this will be taken as 1.0.

Note:

- For masonry this factor affects ACI 530-11 equations 2-16, 2-17, 2-19, 2-21, 2-22, 3-11, 3-12, 3-18, 3-19, and Section 3.3.5.3.
- For wood this affects the C_p factor calculation (specifically F_{CE}) for wood compression capacity for both studs and chord design.

C_m

This input controls the C_m calculation for P-Little Delta calculations for concrete wall panels. If this is left blank the program will auto-calculate this value. See the **P-Little Delta** section of the [Concrete Wall - Design](#) topic for more information.

Inactive

This column allows you define a wall panel as inactive or excluded. Please see the [Inactive and Excluded Elements](#) for more information.

Wall Panel Editor

The **Wall Panel Editor** allows the user to edit the detailed properties of a wall panel including openings, regions and boundary conditions. This dialog also gives design options and details for the specific panel and is accessible by double-clicking on an existing wall panel.

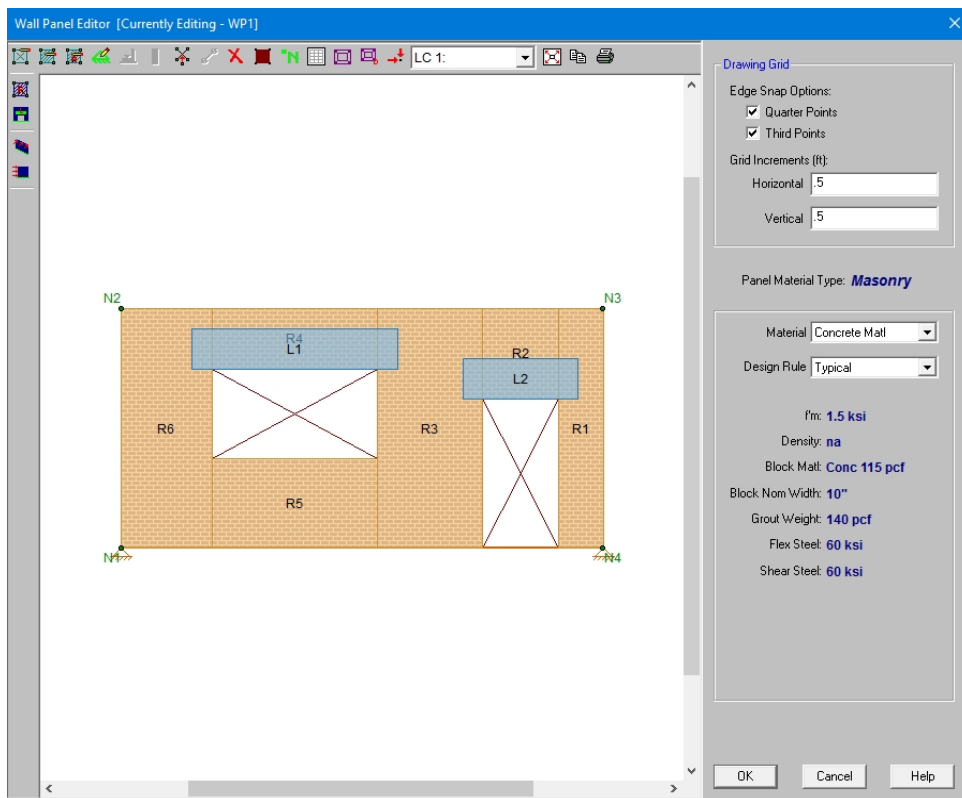

If the wall panel is drawn clockwise it will be drawn with the panel's local x-axis going from left to right. If drawn counter-clockwise the panel's x-axis will go from right to left and is presented here as though you are looking at the back side of the panel.

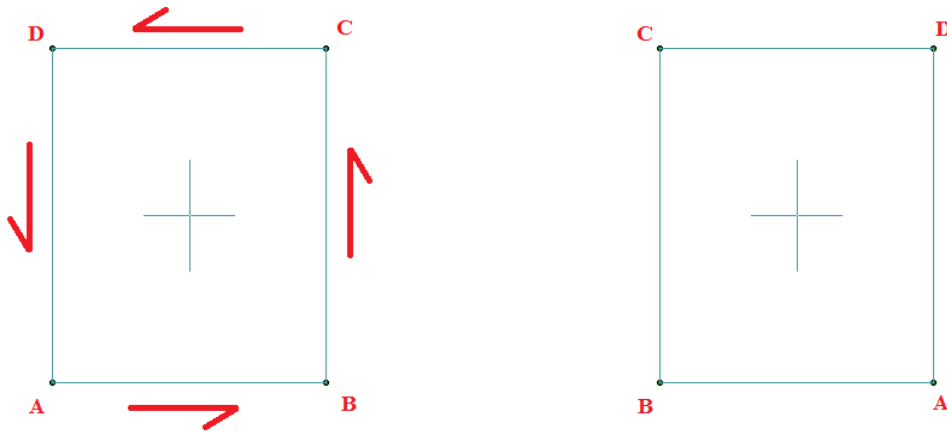

Note:

- There are many icons, dropdown lists and information shown depending on the type of wall panel you are working with. See the [Masonry Wall - Modeling](#), [Wood Wall - Design](#) and [Concrete Wall - Design](#) topics for more information.

Creating Openings

Within the **Wall Panel Editor**, you have the option of adding rectangular openings to the wall panel. To draw an opening, select the **Create New Openings**  button and then select two grid intersections which make up the two diagonal corners of your opening. Notice that you can view your cursor coordinates in the lower right

portion of your screen. The opening dimension is also displayed based on the first click of the opening relative to the second click.

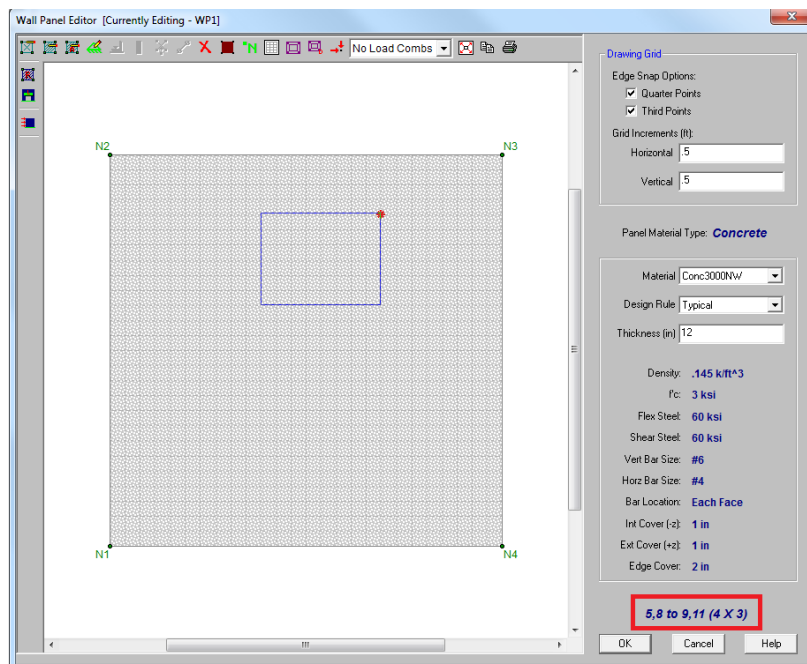

To exit this tool right-click your mouse.

Note:

- Drawing an opening in a concrete wall will create a lintel above the opening. We will not design the lintel but we will give analysis results. See the **Concrete Wall - Design** topic on [lintels](#).
- Drawing an opening in a masonry wall will create a lintel above the opening. For more information on defining lintel geometry and design properties, see the **Masonry Wall - Design** topic on [lintels](#).
- Drawing an opening in wood wall will create a header above the opening. For more information on defining the header properties, see the **Wood Wall - Design** topic on [headers](#).
- Drawing an opening in a general wall panel, there is no header/lintel automatically created. The general wall panel is given as an option for analysis only.
- Openings can not overlap a region. Regions must be deleted before you draw an opening in an area. After the opening is created you can go back and redraw the regions.
- Openings must be drawn greater than 3 inches away from wall edges.

Creating Regions

Within the Wall Panel Editor, you also have the option of creating different rectangular regions within your wall panel. Regions are used to further define areas of your wall panel for use in analysis/design. If you do not specify a region in a wall panel without openings, then the entire wall panel will be considered a region.

To automatically draw regions you must first have your openings input. Once you have that you can click the

Generate Wall Regions Automatically  button and the program will define regions as we would expect a user to want them.

Note:

- If the regions defined are not located correctly by the generator, you can delete the generated regions with the Delete  button and redraw them manually. See below for more information on this.

To manually draw a region, select the **Create New Regions**  button and use your cursor to select two grid intersections which make up the diagonal corners of the region. Similar to wall openings, local coordinates and region dimensions will be displayed in the lower left corner in the Wall Panel Editor. To exit this tool right-click your mouse.

Note:

- For masonry wall panels, there is a region editor that allows you to define design properties for the region. Double-click inside the boundary of the drawn region to open this editor. See the **Masonry Wall - Design** topic for [region](#) information. Note that design and analysis results are displayed by region.
- For wood wall panels the design and analysis results are displayed by region.
- For concrete wall design, the program will automatically create regions at solution around openings. If there are floors/diaphragms that cut through your wall, then separate regions/designs will be created above and below the floors/diaphragms.
- For general wall panels we will not do any design for you. However, you can lay out your regions so that your analysis results will allow you to design your general wall panels much more easily.

Boundary Conditions

Within the **Wall Panel Editor**, all boundary conditions are applied as continuous along a wall panel edge. To set boundary conditions within the wall panel editor, select the **Create New Boundary Conditions**  button, select your boundary condition criteria, and select **Apply**. To exit out of this tool right-click your mouse. You can also apply boundary conditions to your wall panel outside of the Wall Panel Editor as well, but this is the only place where you can define a continuous boundary condition.

For wood wall panels, hold downs and straps are used in the program as well. For more information on adding hold-downs and straps, see the [Wood Wall - Design](#) topic.

Drawing Grid

The drawing grid, which appears in the upper right corner of the Wall Panel Editor screen, gives the user options for drawing within the Wall Panel Editor window. The options include:

Snap Options allows you to provide snap points at the edges of the wall panel at quarter and third points.

Grid Increments allow you to set a drawing grid within the Wall Panel Editor separate from that in the main model view that you can snap to when drawing openings and regions. This field can work in two separate ways:

- A single increment: If you put a single value here (0.5 ft for example), then this increment will be used across the entire wall until the end of the wall is reached.
- Multiple input increments: If you have specific locations you wish to define you can use this field to place exact grid points. Commas are used to delineate different grids and @ symbols can be used to apply the same increment multiple times (5, 10, 2@8, 3 for example). If you place multiple increments in and you are not yet to the end of the wall then the last increment defined will be used until the end of the wall is reached.

View Controls

In addition to the wall panel editing tools, the **Wall Panel Editor** window includes the following view controls:





Delete allows you to delete openings, regions or boundary conditions from the wall panel.





Render will turn rendering of the current model view on or off, depending on the current setting.

 **Nodes** will show any nodes that fall in the plane of the wall panel and allow you to snap to them when drawing regions or openings.

 **Drawing Grid** will turn the display of the Drawing Grid on or off, depending on the current setting.

 **Detach Wall Panel From Diaphragm** will allow you to click on a diaphragm in the editor to detach it from the wall. The detached diaphragm will then show up in gray.

 **Loads** will turn the display of the wall panel loads on or off, depending on the current setting.

 **Redraw Full Wall View** redraws the wall panel to fit within the **Wall Panel Editor** window.

 **Copy Current View** makes a copy of the current view and saves it to the clipboard.

 **Print Current View** prints your current wall panel view.

Note:

- There are also view controls specific to concrete and masonry. For more information see the [Concrete Wall - Design](#) and [Masonry Wall - Design](#) topic.

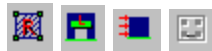

- There are also view controls specific to wood. For more information see the [Wood Wall - Design](#) topic.



Wall Panel Local Axes

When a wall panel is drawn it comes along with a set of local axes. If the wall is drawn clockwise versus counterclockwise it will change the direction of the local axes.

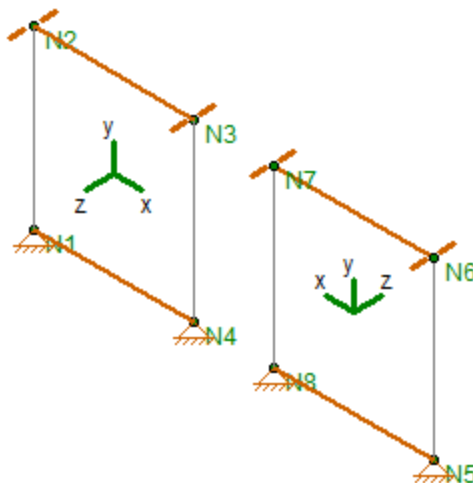

In most cases the local axes direction does not affect results. Here is a list where the local axis is important:

- **Applying Loads:** Wall panel surface loads can be applied to the local axes directions. Thus, the local axes direction will affect the sign of the applied load.
- **Viewing Plate Contours:** Wall plate contours can be viewed based on local axes, thus knowing the orientation is necessary to get meaningful information from these contours

- Out-of-Plane Concrete Wall Design: Concrete cover can be different for each face of a concrete wall. Which face you are defining is based on the +z and -z local axes.

Note:

- Check out the [Out of Plane Flip](#) command to allow you to change these local axes.

Loading

Wall panels can be loaded either directly or indirectly from supporting other elements (other walls, columns, beams, etc.). Line loads and distributed loads can be applied directly to wall panels, similar to how they are applied to members. These loads can be applied vertically or horizontally. Wall panel surface loads can also be applied directly to the wall.

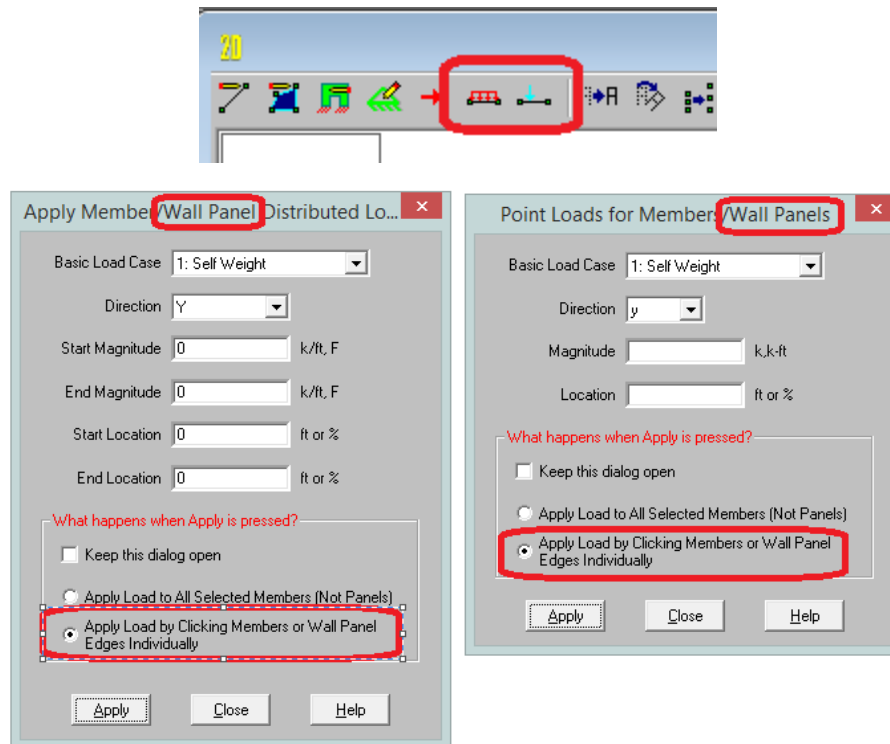

Load Attribution

In RISA-2D, the use of finite elements dictates how loads pass through wall panels. Load is attributed to the structure according to relative stiffnesses of elements. In concrete, wood and masonry design, many empirical equations are formed based on approximations or idealizations. Because of this, you may not get your loading in your wall panel elements (regions and lintels) to match hand calculations exactly. A prime example of this occurs with the 45 degree rule for lintels for masonry. According to theory, arching action occurs in lintels to the point that, if the top of your wall is a sufficient distance away, only the load in the triangular portion above your lintel would actually be taken into the lintel itself. Also, no load applied at the floor level would be felt by the lintel either. See the image below.

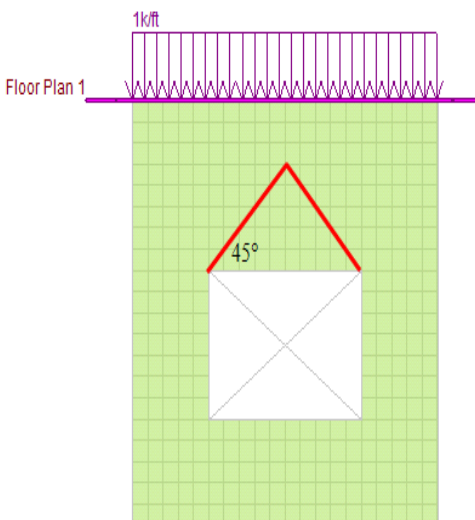

Within RISA-2D, this idealization will not hold true. The wall panel is a finite element mesh that attributes load according to the plate mesh FEM behavior. The load that is getting into the lintel is a true representation of how the wall is actually working. There is still arching action taking place as you can tell if you look at the vertical force contours in the wall panel.

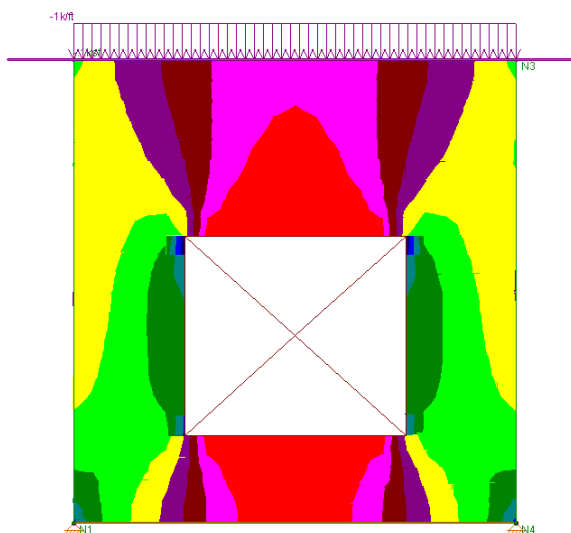

In the image above, the red color is an area of very low axial force in the wall. Thus, you can see that, due to plate distribution of force, there is still arching action taking place. This arching action, however, will not be immune to additional loads added to the wall or the opening being located lower in the wall (as is assumed with the idealized arching action in many texts). Thus, though your loads for lintel design may not be identical to what idealized methods might consider, this is a rational loading for the geometry and loading input on the wall panel.

Meshing the Wall Panels

At solution time, the wall panels will be automatically meshed into quadrilateral plate elements. Unlike the plate elements created directly by the user, the automatically generated plate elements are transient in the program and will not be saved in the input file.

The wall panel meshing is treated similar to analysis results. When the results of an analysis are deleted, the wall panel mesh is cleared to be re-built during the next solution. When a solution results file is saved, the meshed elements will be included in that file.

Mesh Size

The global mesh size for the wall panels can be input on the [Solution](#) tab of the Model Settings. The smaller the mesh size, the more accurate the analysis will be. However, smaller mesh size will also lead to longer solution time and more memory usage. The default mesh size is 12 inches RISA-2D.

Localized small mesh sizes are used in the lintel locations for masonry walls, in order to achieve more accuracy for the lintel forces.

Graphical Display of the Wall Panel Mesh

By default, the plate elements associated with the wall panels are not visible to the user. The mesh can be turned on using the setting on the [Panels](#) tab of the Model Display Options. The **Show Mesh** check box will turn the display of the wall panel mesh on or off.

Note

- The display of the mesh is only available when there are active analysis results.

Point Constraints for the Panel Mesh

Point constraints are the locations within the wall panel that require connectivity to the meshed plate elements. The program will automatically generate point constraints at the following locations:

1. Location of an existing joint on the wall panel edges, region boundaries and opening boundaries.

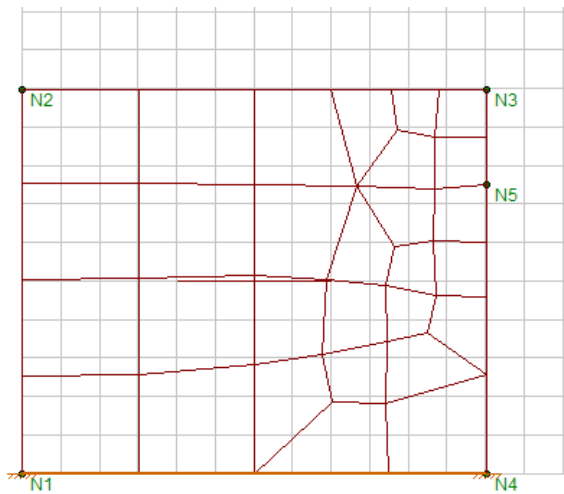

2. Where beams intersects the wall panels (out-of-plane) on the wall panel edges, region boundaries and opening edges.

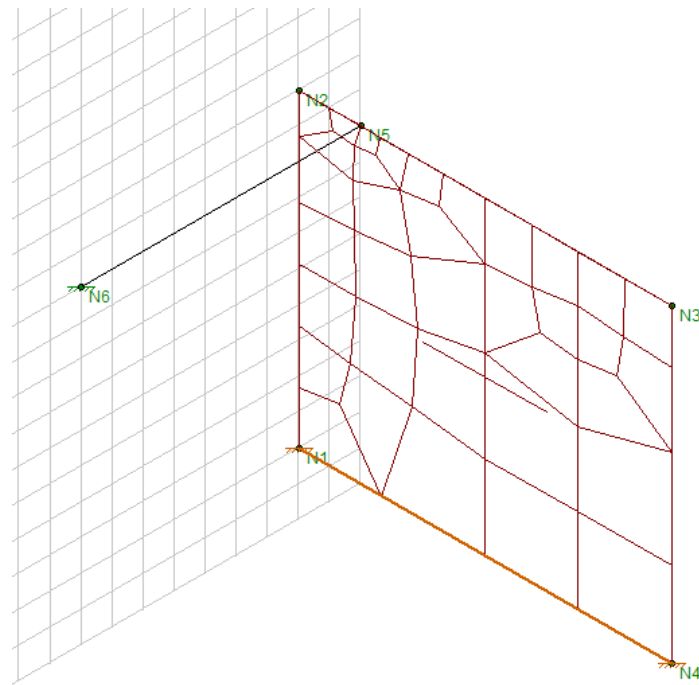

2. Location of an external boundary condition.

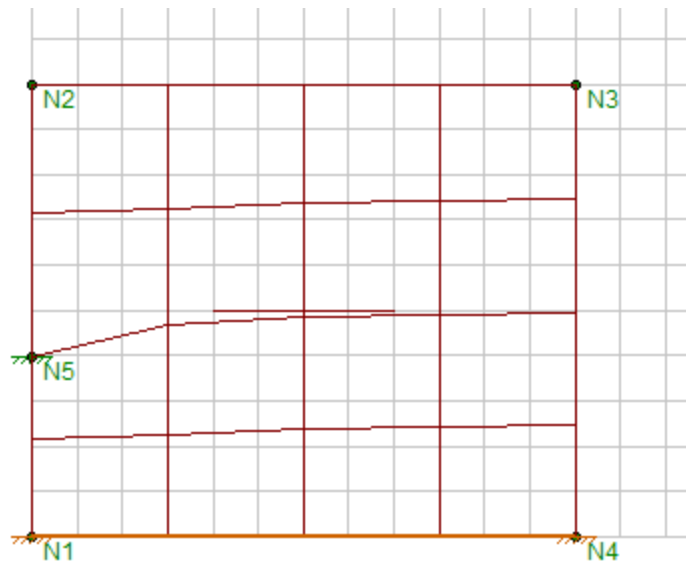

Note:

- Unattached joints that are located on the wall panels can be considered as point constraints and prolong the meshing time. It is highly recommended that the user delete any unattached joints before solving.

Line Constraints for the Panel Mesh

Line constraints are the locations within the wall panel that require continuous connectivity to plate edges rather than a single point. The program will automatically generate line constraints at the following locations:

1. Opening edges.

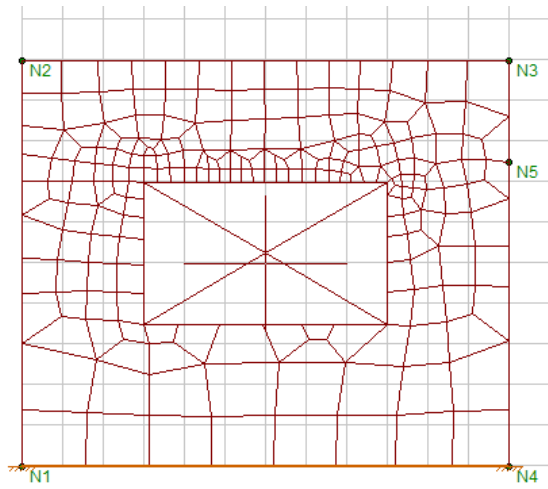

2. The edge and vertical centerline of a defined region.

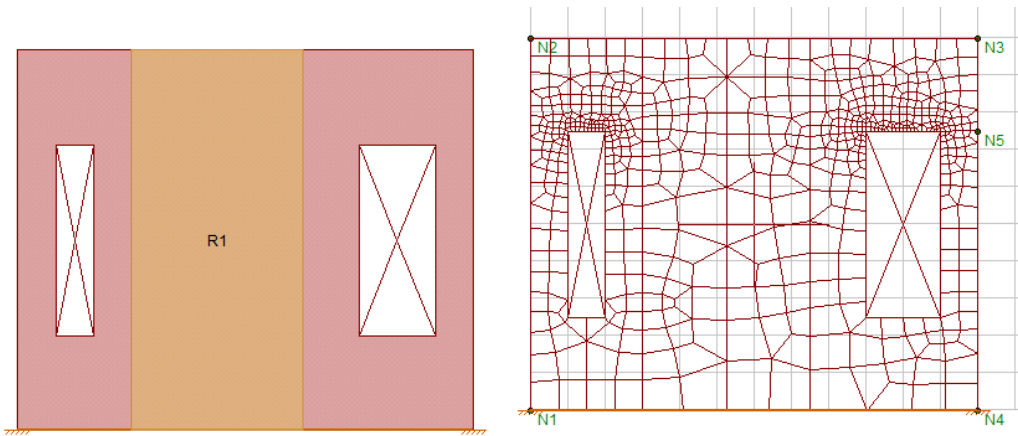

3. Where a diaphragm intersects the wall panel.

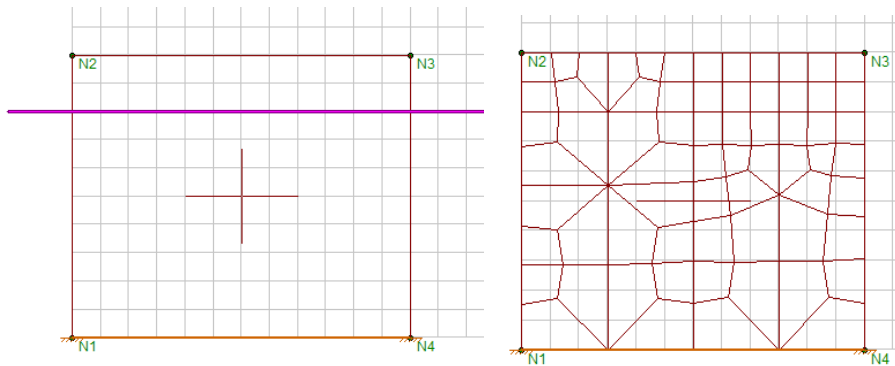

4. Where a beam or column element intersects within the plane of the wall panel.

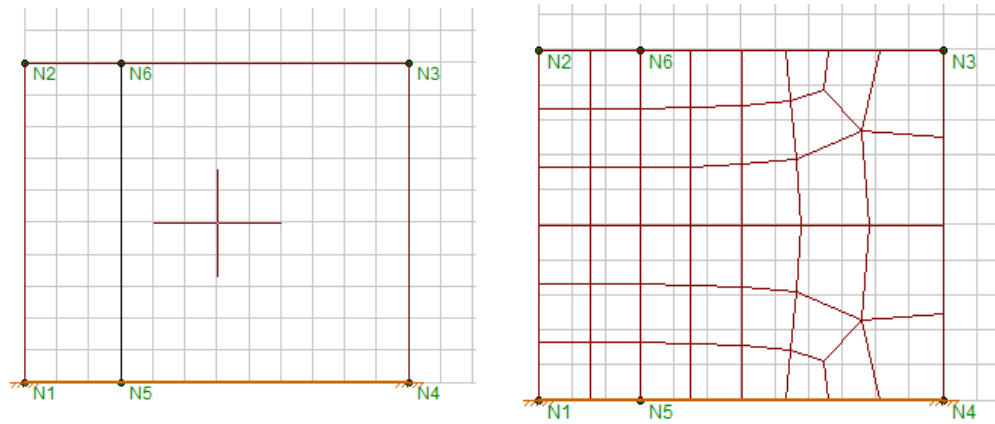

Tips for Ensuring an Accurate Mesh

In order to generate an efficient mesh that gives accurate results, it is critical to place the line constraints and point constraints correctly. If line constraints or point constraints are very close to each other, the auto mesher will be forced to generate small sized elements in order to satisfy the constraints. Therefore, a large number of plate elements will be generated and the solution will be slowed down significantly.

The following guidelines should be followed to ensure a quality mesh:

- Avoid generating very narrow regions and openings.
- Avoid small offsets between the external boundary conditions with the location of the region boundaries and wall boundaries.
- Avoid small offsets between opening edges with the region boundaries .
- When a wall panel is intersected by another wall panel, diaphragms, beams or plate elements, keep in mind that the intersection is a line/point constraint. Avoid the small offsets between intersections with the region boundaries or opening edges inside the wall panel.

Example #1: Region Boundaries

1. The left boundary region R1 is placed very close to the opening but not on the opening.
2. The left boundary of region R2 is placed very closed to the left edge of the wall but not exactly on the wall boundary.

In order to satisfy the line constraints required by the opening edge, region boundaries, and wall boundaries, the program is forced to generate very small meshes in the portion of the wall adjacent to these constraints.

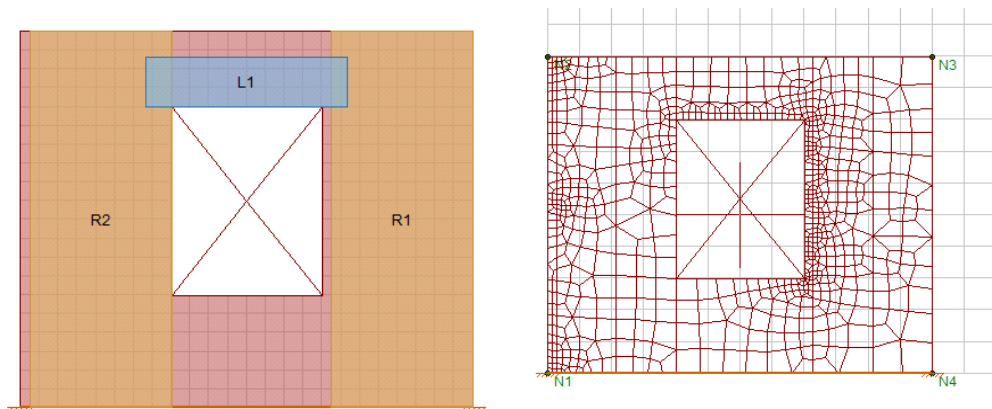

Example #2: Poorly Located Boundary Conditions:

The left boundary of region R1 is at the vertical center line of a wall panel. At the same time, the user placed an external boundary condition at the bottom of the wall panel, which is slightly offset from the center line. In order to accommodate the line constraint of the region boundary and the point constraint of the external boundary condition, the automeshing is forced to generate a very small mesh adjacent to these constraints.

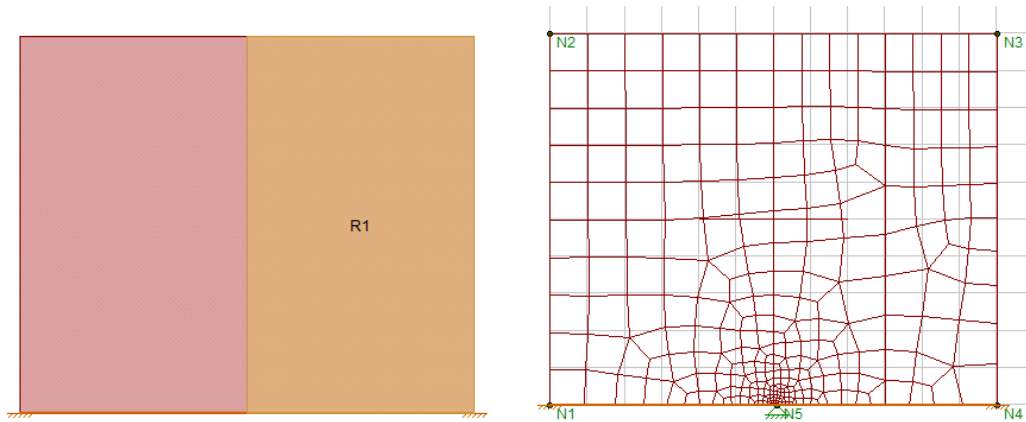

Merge Tolerance for Auto-Correction of Mesh

If the distance between the line constraints and point constraints are smaller than the merge tolerance specified on the Model Settings (which defaults to 0.12 inches) then the auto-mesher will automatically snap the constraints together during the meshing. This can eliminate some of the meshing issues that occur in the examples above.

Wall Panels - Results

When the model is solved there are results spreadsheets. The Wall Panel Design spreadsheets are divided into different tabs: In plane, Lintel, Wood Wall Axial, Wood Wall In-Plane, Wood Header and Wall Panel Seismic. Each tab gives code checks based on the relevant code depending on the material type. These spreadsheets can be used as a summary of all of the panels in your model. To get detailed information about each panel, you can use the Wall Panel Detail Reports.

Concrete Wall Spreadsheet Results

- [In Plane Results Spreadsheet](#)

Concrete Wall Detail Reports

- [Wall Summary Detail Report](#)
- [In Plane Detail Report](#)

Masonry Wall Spreadsheet Results

- [In Plane Results Spreadsheet](#)
- [Lintel Results Spreadsheet](#)

Masonry Detail Reports

- [In-Plane / Shear Wall Detail Report](#)
- [Lintel Detail Report](#)

Wood Wall Spreadsheet Results

- [Axial Results](#)
- [In Plane / Shear Results](#)
- [Header](#)

Wood Wall Detail Reports

- [In-Plane or Shear Wall Detail Report](#)

Wall Force Results

The Wall Force Results spreadsheet lists the axial force, shear and moments for each wall panel. The elevations where forces are reported are at the base of walls and at the locations of any diaphragms that intersect the walls. The elevation is given in terms of global elevation.

The **Wall Label** column displays the wall panel label.

The **LC** column reports the relevant Load Combination.

The **Elevation** column reports the elevation (in Global Coordinates) at which the forces are reported.

The **Axial** value reports the axial force in the wall. Compression force is reported as positive, Tension force as negative.

The **x-Shear** value is the shear force in the local x direction for the wall. This is the shear wall / strong direction of the wall.

The **z-z Moment** value is the moment about the local z axis for the wall. This is the shear wall / strong direction of the wall.

General Wall Detail Report

The general wall detail report shows the material type, height, length, and envelope forces for general walls.

Note

- No detail report is generated for general walls with openings when there is no region defined.

The **Wall Panel Results Spreadsheet** displays the calculated results for wall elements and may be accessed by selecting **Wall Panel Design** from the **Results** menu . The spreadsheet has fivetabs: **Concrete In, Concrete Out, Masonry InMasonry Lintel, Wood Wall Axial, Wood Wall In-Plane, Wood Header** and **Wall Panel Seismic**.

The first tab as well as the last tab gives results of **Concrete Wall** analysis. For more information on these tabs see [Concrete Wall Results](#) and Concrete Wall - Seismic Results.

The next two tabs are results of **Masonry Wall** analysis. For more information on these tabs see [Masonry Wall Results](#).

The next three tabs are results of **Wood Wall** analysis. For more information on these tabs see [Wood Wall Results](#).

CFS Wall - Design

The CFS wall panel element allows you to easily model, analyze and design CFS walls for in-plane loads. Here we will explain the specific inputs and design considerations. For general wall panel information, see the [Wall Panels](#) topic. For CFS wall results interpretation, see the [CFS Wall Results](#) topic.

For additional advice on this topic, please see the RISA Tips & Tricks webpage at risa.com/post/support. Type in Search keywords: **CFS Walls**.

Full code checking and design can be performed on the panel sheathing, studs, and chords based on the following codes:

- The AISI S240-15 CFS Structural Framing & AISI S400-15 w/S1-16 Seismic Design of CFS Structural Systems

CFS Wall Input

The **Wall Panel Editor** gives some specific information and options for modeling/analysis of CFS walls.

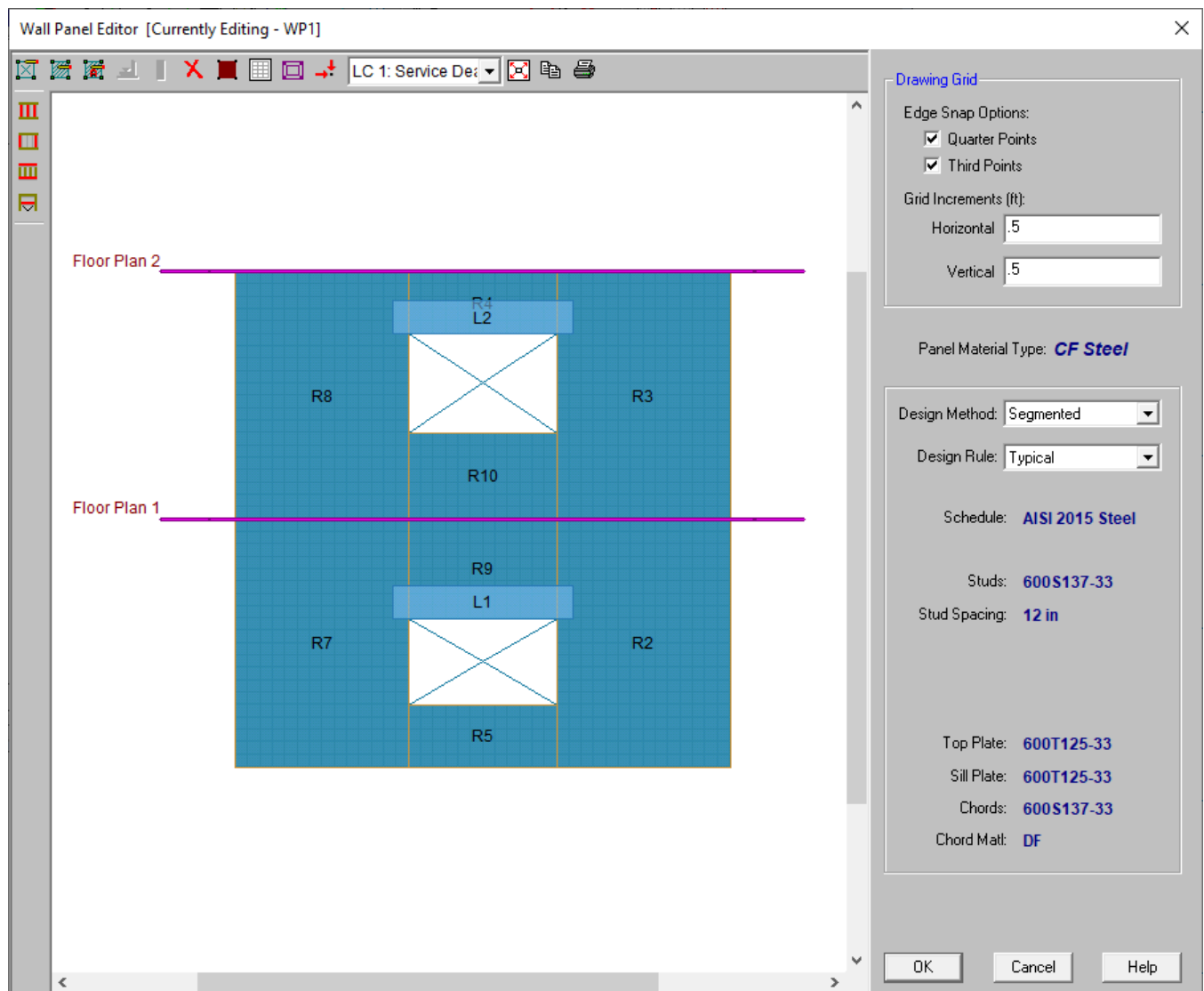

CFS View Controls



Toggle Wall Studs Display allows you to turn the display of the studs on and off.



Toggle Wall Chords Display allows you to turn the display of wall panel region chords on and off.



Toggle Top/Sill Plate Display allows you to turn the display of the top/sill plates on and off.



Toggle Opening Headers Display allows you to turn the display of headers on and off.

Design Rules

You must set up design rules for the stud/chord sizes, as well as make database selection for shear panels. This is done in the **Wall Design Rules** spreadsheet in the **CFS Wall (Studs)** and **CFS Wall (Fasteners)** tabs. See the [CFS Wall - Design Rules](#) topic for more information.

Creating Openings in CFS Walls with Headers

Within the **Wall Panel Editor** tab, you have the option of adding rectangular openings to wood wall panels. To draw an opening, select the **Create New Openings**  button and then select two nodes or grid intersections which make up the two diagonal corners of your opening. When an opening is drawn, a header beam is automatically created above the opening. Currently header design is not available for CFS walls

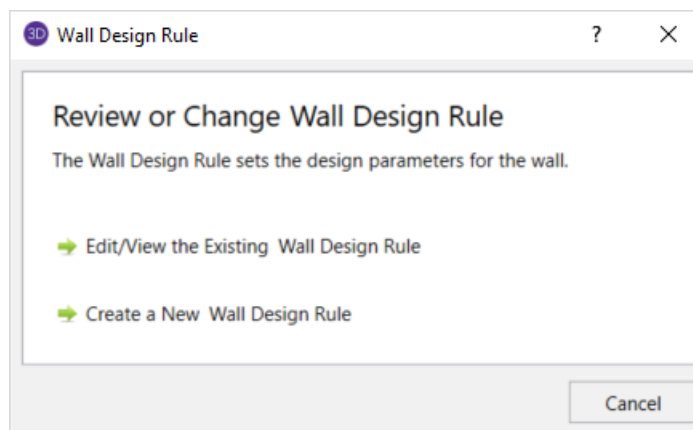

Label - This defines the name of this header and shows up in the results output for this header.

Wall Design Rule - This is the default setting here and is the default header information for all headers in the wall.

Custom - This allows you to define a header size and material that is different from the Wall Design Rule. You would only set a custom header if you have multiple headers in the same wall that are different sizes.

Hold-Downs and Straps

Hold-downs and straps are automatically added to your walls in their required locations. For a Type I - Segmented design, you must have hold-downs or straps at the bottom corners of each of your design segments. The program will not permit the drawing of hold-downs or straps at locations where they are not allowed.

If there are custom locations that you want to add hold-downs or straps, you can do this within the **Wall Panel Editor**.

Hold downs can represent the anchorage of your wall to the foundation or the connection of shear wall chords between floors. To add hold-downs to the base of your wall, first select the **Add New Wood Hold Downs** button



Hold downs must be added after regions are created and can only be added at the corners of regions. Hold down requirements depend on the type of wall design you are performing.

Straps represent the connection of the current wall panel to a wall panel below. To add straps to the base of your wall, first select the Add New Wood Straps button .

Straps also can only be added after regions are created and can only be added at the corners of regions. Strap requirements also follow the same logic as hold downs as to where they must be defined as far as regions are concerned.

Note:

- Hold-downs and straps are not designed for CFS Walls. However, the required forces will still be reported. More information on this can be found in the CFS Wall Results topic.
- All boundary conditions for wall panels should be defined in the wall panel editor. Adding external boundary conditions can create problems.
- The locations of hold-downs and straps define where the program will calculate tension forces in your walls.
- By default, the program will automatically add hold-downs to the base of walls that have boundary conditions applied to them and will apply straps to walls that have walls below.
- All Straps and Hold-downs are placed at the base of walls only. So, if you would like to put a strap or hold-down between floors, you would apply it to the base of the upper wall.

General Requirements for Shear Walls

The design of CFS shear walls per the available design codes requires that many criteria are satisfied before a wall can be considered adequate. For RISA to work within this framework, we require that certain modeling practices be followed. Outlined below are many general wall modeling practices and limitations as well as specific requirements for the Type I - Segmented method that is available for CFS Walls in the program.

Note:

- RISA-3D does not currently support Type I with FTAO or Type II walls.

Type I - Segmented Method

The Type I - Segmented methodology is defined in Section B5.2 of the *AISI S240-15 North American Standard for Cold-Formed Steel Structural Framing*.

Where there is a wall panel with openings, the area above and below the openings is disregarded and the wall is designed as being made up of separate, smaller shear walls.

Like all wall panels, the segmented CFS wall is broken into a series of meshed plate elements to represent the overall wall. The portions of the segmented shear wall that are considered "ineffective" in resisting shear are modeled with a plate elements that have a significantly reduced shear stiffness so that they will not receive any significant moment or shear from the FEM analysis.

See the diagram below for more information:

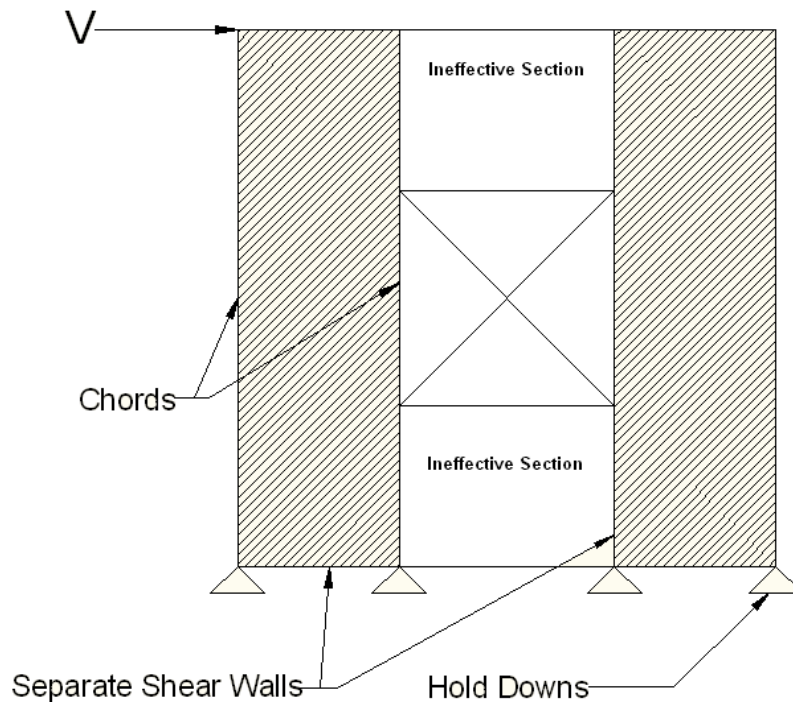

In addition, the out of plane stiffness and in plane stiffnesses of the segmented CFS wall are modeled separately based on different assumed plate thicknesses. This is done to insure that the shear stiffness is based entirely on the properties of the sheathing and is not influenced by the out-of-plane stiffness of the wall studs.

Note:

- If you have several stacked Segmented wall panels with misaligned openings, you will receive the Warning Message shown below upon solution. This message means that RISA-3D has assumed that the strap force from the above wall panel will be spread out across the region directly under it. Therefore, you need to be aware of this assumption and detail the wall panel accordingly.



- A shear panel design will be chosen for the worst-case region in a segmented wall. That panel will then be used for all regions in that wall. The worst-case region is the one that has the highest Shear UC value.

Geometric Requirements and Limitations

The program will check the geometric requirements per AISI S240-15 B5.2.1.1 and AISI S400-E1.4 as required unless otherwise noted below. The sections noted below are assumed to be satisfied and are not checked.

Note:

- AISI S400-E1.4 parts (d) - (g) and (k) - (r)
- AISI S240 B5.2.2.3.2.1.1 parts (c) and (e)
- AISI S400 E2.3.1.1.1.1 parts (c) and (e)

General Program Functionality and Limitations

Assigning Code and Design Methodology

CFS wall designs will be based on the *AISI S240-15 North American Standard for Cold-Formed Steel Structural Framing* and *S400-15 w/S1-16 North American Standard for Seismic Design of Cold-Formed Steel Structural Systems*. You can select these codes in the CFS Walls dropdown within the Codes section of the Model Settings. If you set this code to “None”, the program will not perform design for the CFS walls.

The design properties of CFS stud and chords within the wall are referenced from the AISI S100 specification referenced in the Cold Formed Steel dropdown.

In this manner, the design methodology (ASD or LRFD) for the entire wall panel (stud, chord and sheathing design) is determined by the design method selected in the Cold Formed Steel dropdown. For example, if the AISI S100-16: ASD code is selected as shown below, the CFS walls will use ASD factors in the stud, chord and sheathing designs.

Modeling Tips- Platform Framing

The CFS wall height in RISA is measured from the bottom of the sill plate to the top of the floor framing as shown below. However, platform framing causes the wall height to be significantly shorter than a RISA model would represent.

This is especially problematic for the FTAO design method where the region above openings is assumed to be much larger than it is built. However, currently only the Type I - Segmented method is available and the portions above and below the opening are not used to transfer shear forces.

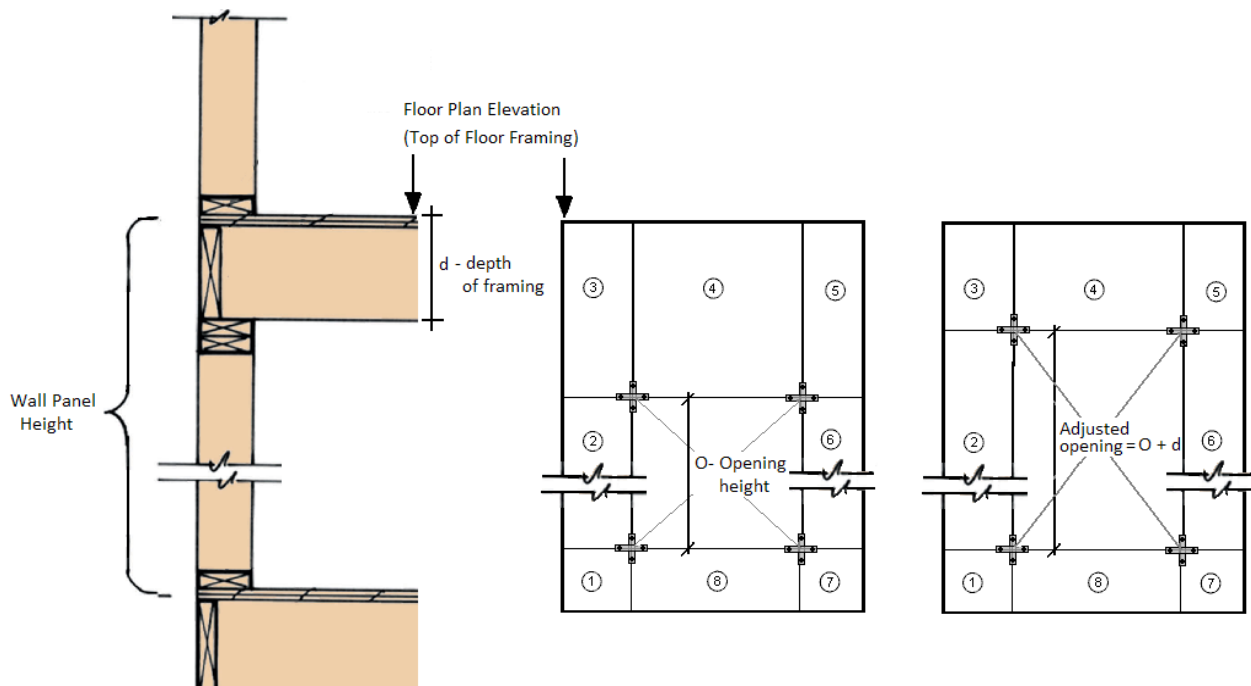

Limitations for Hold-downs / Straps (Including deformation)

- The program does not currently have a database for or optimize hold-downs/straps for CFS walls.
- The manufacturer listed or user defined hold-down deformation can be input in the Wall Design Rules spreadsheet for inclusion in the design deflection calculation. See the CFS Wall - Results topic for more information.

Automatic Boundary Conditions

- In RISA-2D, if no boundary conditions or hold downs are defined for CFS wall panels at the lowest level of the structure, the program will automatically create hold downs at the corners of the wall panel. If you do not want the hold downs to be automatically created, define a "free" boundary condition at the base of the wall panel in the wall panel editor.

Deflection

The program will report the design deflection for CFS shear walls that have wood or steel sheathing.

- There is currently no code check for drift or deflection for CFS shear wall panels.

Stud Design

Studs are only designed for load combinations which do not contain a wind or seismic load. The maximum axial load, determined as an envelope force from all of the "gravity" load combinations which have been solved, is determined for each region.

Studs are checked per AISI S240-15 B3.2: Wall Stud Design. The program currently only uses the All Steel Design methodology in which case bracing from the attached sheathing or structural bracing is ignored. Therefore the unbraced length for the buckling of the stud is taken as the full wall height. The top and bottom track thicknesses are considered negligible and are not deducted from the total height.

Note:

- The program currently does not optimize the stud size or spacing.
- The program will use an effective length factor, K , equal to 1.0 for the design of the studs.

Stud force demand and number of studs calculation:

The program first divides the maximum axial force in the region by the length of the region. Then it will multiply this distributed force by the stud spacing to get a maximum stud demand.

The program calculates the number of studs based on the following procedure:

1. Determine the number of spaces between studs by dividing the region length by the stud spacing.
2. Round this number up to the nearest whole number.
3. Determine the number of studs by adding one to this number.

Openings

- Currently, the program does not perform header design. This will be available in an updated version.

Chord Design

The chord design is based on forces that are calculated differently for Compression versus Tension. The tension chord force is calculated including the dead load stabilizing moment. The compression chord force includes the

only the tributary area of one stud spacing in the compression force. For Segmented design, the chord forces are found based on each region.

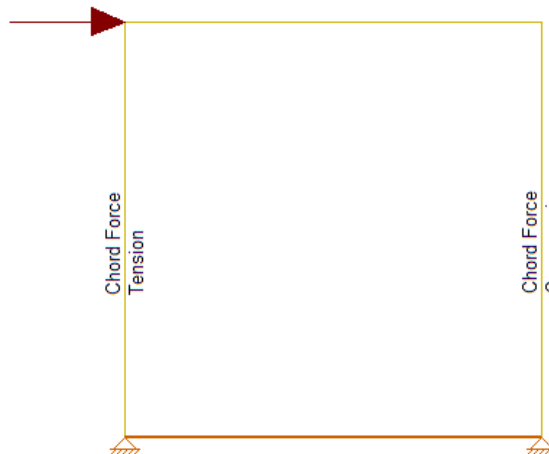

Chord forces are calculated per the following equations:

$$\text{Compression Force} = \frac{M}{L} + \frac{P}{n}$$

$$\text{Tension Force} = \frac{-M}{L} + \frac{P}{2}$$

Where:

- M = Moment at the base of the wall
- L = Length of the wall
- P = Axial force at the base of the wall
- n = Number of Studs = Length/Stud Spacing

Notes:

- In RISA-3D, the edge of the CFS walls represent the centerline of the chord member. Therefore, the depth of the chord member will not affect the chord force calculation since the centerline of the chord member will always be assumed at the edge of the wall.
- The eccentricity checkbox in the Wall Design Rules spreadsheet will not affect the chord force calculation.
- RISA-2D models the shear walls using only the sheathing. The vertical resistance occurs only at the tension and compression chords. Thus, if two wall panels are stacked on top of each other, the load transfer will only happen at the chord locations. Therefore, the lateral analysis should agree very well with hand calculations. However, it also means that gravity load design may be more appropriate in RISAFloor.

Hold-Down Force

Hold-Down forces are calculated per the following equations:

Note that the hold-down force calculation will be dependent on if the eccentricity checkbox has been checked and the value input in the eccentricity field.

- When the "[Eccentricity](#)" check-box is unchecked in the CFS Wall Design Rule (Fasteners tab), the hold-down force is exactly equal to the chord force indicated above.
- When the "[Eccentricity](#)" check-box is selected in the CFS Wall Design Rule (Fasteners tab), an eccentricity distance should be indicated in the "Ecc Dist" column. This distance should be the distance between the hold-down and the centerline of the chord member.

The Hold-Down force is calculated by finding the Tension chord force. In order to accommodate an unsymmetrical vertical load on the wall, the program adopted a more accurate approach by calculating the moment at the compression side first and then finding the resulting reaction on the tension side.

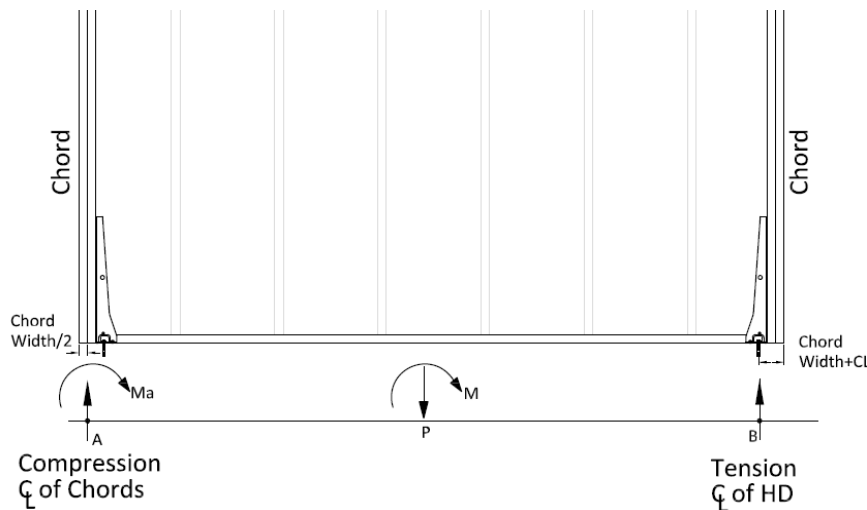

The resulting equation to determine the hold-down force is as follows:

$$\text{Moment at Point a} = M_a = -M + \left(P * \left(\frac{L}{2} - \frac{b_c}{2} \right) \right)$$

$$\text{Reaction at Point b} = R_b = \frac{M_a}{L - 1.5 * b_c - CL}$$

Where:

- M_a = moment at point A (CL of compression chord)
- M = moment at base of the wall
- P = Axial load at the base of the wall
- L = length of the wall
- b_c = width of chord member

- R_b = reaction at point B = hold down force
- CL = Hold down eccentricity distance (per selected hold down)

Lateral Force Distribution

- The lateral force distribution between piers is based on the relative stiffness of the sheathing, not on the length of the shear wall. For example, if you have an 8 foot wall and a 4 foot wall, the 8 foot wall will take more than $8/(8+4)*100\%$ of the force. The moment of inertia in the 8 foot wall will allow for a larger proportion of load to go into that pier.

Shear Panel Material Capacities

Shear capacity of the wall will be dependent on the Sheathing Material and Design Method that was chosen in the Design Rules spreadsheet - CFS Wall (Fasteners) tab. When design values are pulled from design tables, the program will use the appropriate capacity from the table based on the height-to-width ratio of the wall, member thickness of the stud members and type of loading used.

Tabulated shear capacities are based on the *AISI S240-15 CFS Structural Framing* and *AISI S400-15 w/S1-16 Seismic Design of CFS Structural Systems* codes. If the governing lateral load is a seismic load (under the load category EL, ELX, ELY, ELZ, etc) then the capacity will be pulled from the AISI S400-15 code.

Note:

- Curtain wall considerations per AISI S240-15 are not considered in the program.

Wood Sheathing

Tabulated design values are referenced from AISI S240-15 Table B5.2.2.3-2 and AISI S400-15 Table E1.3-1.

Steel Sheathing

Tabulated design values are referenced from AISI S240-15 Table B5.2.2.3-1 and AISI S400-15 Table E2.3-1.

If the Effective Width Method is used as the design method, this will be referenced from AISI S400-15 Chapter E2.3.

Note:

- The program will not perform the end distance check in the effective width method. This is assumed to be satisfied.

Fiberboard

Tabulated design values are referenced from AISI S240-15 Table B5.2.2.3-4. AISI S400-15 does not apply for this material.

Gypsum

Tabulated design values are referenced from AISI S240-15 Table B5.2.2.3-3. AISI S400-15 does not apply for this material.

Stiffness Assumptions

Vertical Direction

RISA uses an orthotropic plate element to de-couple the vertical and shear stiffness of the CFS walls. The vertical stiffness will be based on the E value of the studs and chords as specified in the Materials spreadsheet and the thickness of the wall. The thickness is taken as

$$\text{Thickness} = \frac{\text{Total Wall Weight}}{\text{Material Density} * \text{Wall Length} * \text{Wall Height}}$$

Where,

$$\text{Total Wall Weight} = W_{\text{studs}} + W_{\text{chords}} + W_{\text{top plate}} + W_{\text{sill plate}} + W_{\text{sheathing panel}}$$

In-Plane Shear

The in-plane shear stiffness will be based on the Ga value designated within the specified nailing schedule divided by the sheathing thickness. Both the Ga value and the sheathing thickness are defined in the specified sheathing schedule.

Out-of-Plane Shear

For the out of plane shear, RISA uses the same Young's Modulus (E) as used in the vertical direction and a thickness that is calculated from the out of plane moment of inertia. This becomes:

$$\text{Thickness} = \left(\frac{I_{\text{chord}} + I_{\text{stud}} + I_{\text{panel}}}{\text{Wall Length}} \right)^{1/3}$$

CFS Wall Self Weight

The program will calculate CFS wall self weight as a sum of all the weights of the components. The material density is used to calculate the self weight of the studs, chords, top plates, sill plate, and sheathing. These are all then summed together to give the self weight of the entire wall.

Note:

- For this calculation, stud height equals full wall height.
- The number of studs is calculated using the stud spacing specified in Design Rules.

CFS Wall Optimization

The program will optimize CFS walls based on the required demand forces. The program can optimize sheathing for in-plane shear design.

This optimization can substantially modify the stiffness of the wall. To properly adjust the stiffness requires an iterative solution that updates the stiffness of the model. This includes updating the strength properties of the wall as well as the stiffness. The program will handle this optimization/iteration automatically.

To update the stiffness portion of the wall, the program must re-solve your model with these updated stiffnesses as this will change the distribution of forces through the model. Thus, the program will start with its initial stiffness parameters and solve the model. It will then optimize the wall to meet strength criteria. Another solution will then be run with the new stiffnesses and the program will again optimize the wall to meet strength criteria. This procedure will continue to occur until all wall panel results match those of the previous solution.

The program will always present results in the output that coincide with the stiffness used in the final solution.

Panel Optimization

The procedure that RISA uses for design optimization is fundamentally based upon the assumption that there is a 'cost' to shear capacity, and therefore the ideal panel design would have as little shear capacity as possible to meet code requirements. Once the program has determined the shear demand on the wall it will choose the most economical panel configuration based on that which has a **Shear Capacity** closest to, but not exceeding the shear demand.

The program will also only pick shear panels that qualify based on the region height-to-width ratio and minimum stud thickness requirements.

The default shear panels in the program come straight from published tables in the AISI S240-15 and AISI S400-15.

Note:

- The shear forces listed in the XML spreadsheet are nominal shear strength values. The force capacity will be adjusted by the appropriate factor depending on if the ASD or LRFD design method is selected in the Cold Form Steel code dropdown.
- Panels with a label containing the characters "_W" together will be ignored during design optimization.

CFS Wall - Design Rules

The CFS wall panel element allows you to easily model, analyze and design CFS walls for in plane loads. Here we will explain the CFS specific inputs and design considerations. For general wall panel information, see the [Wall Panels](#) topic. For information on CFS wall design considerations, see the [CFS Wall - Design](#) topic. For CFS wall results interpretation, see the [CFS Wall Results](#) topic.

Unity Check

Max Bending Chk

This will define the hold-down maximum code check value. Currently, hold-down design/optimization is not available for CFS walls. However, this will be made available in a future release.

Max Shear Chk

This will define the shear panel selection maximum code check value. Typically this will always be 1.0, but this allows the option of having the program pick out a shear panel layout that is not at maximum capacity. Putting a value of 0.8 will choose a panel thickness and nailing that is at 80% of capacity.

CFS Wall (Studs)

Top Plate

Use the **Top Plate** column to specify the member to be used as a top plate for your wall. A top plate is a member that runs continuously along the top of the wall studs.

Sill Plate

Use the **Sill Plate** column to specify the member to be used as a sill plate for your wall. A sill plate is a member that runs continuously along the bottom of the wall studs.

Studs

Use the **Studs** column to specify the member to be used for studs in your wall. Studs are vertical members in the wall, attached to the sill plate at the bottom and the top plate at the top. Note that you can use back-to-back or toe-to-toe options as well.

Stud Space

Use the **Stud Space** column to specify the spacing between the studs within the wall.

Header Size

This defines the default header size for all openings. Note that the program will not provide a design for CFS headers at this time.

Design Rules - CFS Wall (Fasteners)

Type of Wall

This option determines the design methodology of the CFS wall panel. Currently CFS walls can only be designed using the Type I - Segmented method.

Sheathing Material

You can select which sheathing material you would like to be used for lateral design optimization. The specific sheathing material that you select will automatically populate the corresponding sheathing database in the adjacent Schedule column.

Schedule

You can select the sheathing database and Panel Group you would like to use for design optimization. By selecting the **Select Individual Panel** option, an individual panel type may be assigned. For information on how the optimization works, see the [CFS Wall - Design](#) topic. For more information on this schedule, as well as information on how to edit or create your own custom schedule, see [Appendix G-CFS Design Databases](#)

Design Method

This column allows you to choose the method in which the lateral capacity will be determined by the program. If you choose the Table option, the program will reference tabulated shear capacities in the AISI S240 and AISI S400 manual. The Effective Strip Method is only available for the Steel Sheet sheathing material option. For more information on this see the [CFS Wall - Design](#) topic.

Min/Max Panel Thick

These values set minimums and maximums for the thickness of the sheathing that will be designed. If the same value is input for both max and min, then that will be the thickness used.

Fastener Min Edge Space Max/Min

These values set minimums and maximums for the spacing of the nails that fasten the sheathing to the boundary members (top plate, sill plate, hold down chords). Note that a 12" spacing is assumed for all field nailing (nails fastening the sheathing to the internal studs).

HD Chords

You can choose what member size you would like to use for the Hold Down Chords (Posts) at both ends of the wall panel.

Eccentricity

This checkbox controls whether the eccentricity distance of the hold-down (input into the Ecc Dist column) will be used in the calculation of the hold-down force. For more information see the Hold Down force calculation section in the [CFS Wall - Design](#) topic.

Ecc Dist

You can use this column to input an eccentricity distance to be used in the calculation of the hold down force. This distance should be measured from the centerline of the HD chord to the actual hold-down anchorage.

HD Deflection

You can use this column to input the manufacturer hold down deflection which will be used in the reported shear wall design deflection calculation.

CFS Wall Results

CFS Wall results are presented in the **Wall Panel Design** Spreadsheet and the detail reports.

For additional advice on this topic, please see the RISA Tips & Tricks webpage at risa.com/post/support. Type in Search keywords: **CFS Walls**.

CFS Wall Results Spreadsheets

CFS Wall Axial Results

The **Wall Panel** column lists the CFS wall panels that you have defined.

The **Region** column lists the wall panel region that the results are based on.

The **Stud Size and Spacing** columns show the stud size and spacing chosen for your wall, based on the [Design Rules](#) you have defined.

The **Axial Check** value is a code check ratio between the member load and the member capacity. The adjacent **Gov LC** column shows the governing load combination for the design.

The **Chord Size** column shows the optimum chord size chosen for your wall, based on the [Design Rules](#) you have defined. Note that the chords are the vertical hold-down members/posts at the both ends of the wall.

The **Chord Axial Check** value is a code check ratio between the member load and the member capacity. The adjacent **Gov LC** column shows the governing load combination for the design.

Note:

- When running the [Segmented](#) design method, the wall panel regions above and below the opening are not considered in design. Thus an NC (no calculation) will be displayed.
- If there are some constraints that will not allow a wall to be designed, an NC (no calculation) will be displayed. Check the **Warning Log** within the program for more information on this.

CFS Wall In-Plane Results

The **Shear Panel Label** shows the optimum shear panel arrangement chosen for your wall, based on the [Design Rules](#) you have defined.

The **Region** gives the region for which the design values are being displayed.

The **Shear Check** value is a code check ratio between the panel shear load and the panel shear capacity. The **Shear Force** and **Gov LC** show the values and load combination which governed the design.

The **Hold-Down Force** and **Gov LC** show the maximum value of hold-down/strap and the load combination which produced the highest strap force. This maximum force could occur on either end of the wall/region.

Note:

- When running the [Segmented](#) design method, the wall panel regions above and below the opening are not considered in design. Thus an NC (no calculation) will be displayed. If running a combined RISAFloor and RISA-3D model use RISAFloor to get header results.
- If there are some constraints that will not allow a wall to be designed, an NC (no calculation) will be displayed. Check the **Warning Log** within the program for more information on this.
- If 'default' is shown in the **Hold-Down Label** column it means that a hold down is not required for this wall/region.

CFS Wall Self Weight

The program will calculate the self weight of a CFS wall based on the weights of the individual components. Using the material density, the self weight is calculated for the studs, chords, top plates, sill plates, and sheathing. These are all then summed for the total self weight of the wall.

CFS Wall Detail Reports



The detail report gives detailed information about the wall design. The detail reports are specifically molded to the type of design specified.

Note:

- Only the **Segmented** design method is considered for CFS walls at this time.
- Many of the values for design checks seen below are not performed in RISAFloor as it is strictly a gravity design program.

Accessing the Detail Reports and the Specific Windows

Once you have a solved model, the detail reports become available. They are accessible in two ways:



1. If you have the Wall Results spreadsheet open, there will be a button at the top of the screen: . This will open up the detail report window.
2. If you are in a graphic view of your model, there is a  button that will open up the detail report window.

Note:

- Detail report information is not available for an envelope solution.

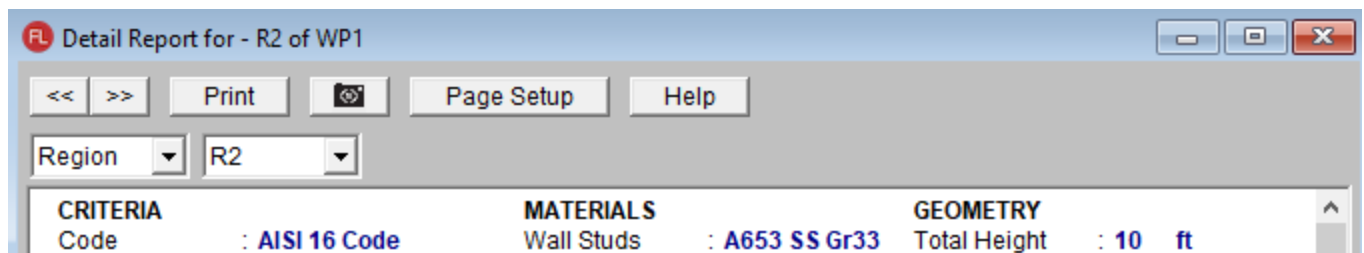
Once the detail report window is open, you will see a dialog area at the top.



-   - Allows you to click between the different wall panels in your model.
-  - This button will allow you to take a snapshot of the current detail report you are viewing so that it can be added to a report. View the [Printing](#) topic for more information.

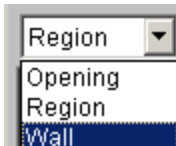

-  - This dropdown list allows you to select between the three different parts of the wood wall panel detail report. Below we will explain the importance of each of these sections.



- This dropdown list allows you to select between different regions or headers defined within the individual wall panel.

The Wall detail report gives an overall summary of your wall, complete with governing code checks and opening information.

Segmented Method

The **Segmented** design method uses each of the three detail report sections to give design information.

Wall Window

This window gives an overview of the wall, giving controlling region information and deflection information. Note that this window only gives information on the full-height segments in your wall, as this is the basis of the **Segmented** method.

Input Echo

GENERAL

Code : **AISI 16 Code**
 Design Method : **Segmented**
 Wall Material : **A653 SS Gr33**
 Function : **Lateral**

GEOMETRY

Total Height : **20** ft
 Total Length : **20** ft
 Parapet Height : **0** ft
 Wall H/W Ratio : **1.00**
 K : **1.00**

MATERIALS

Description	Material	Size
Top Pl	A653 SS Gr33	800T150-54
Sill	A653 SS Gr33	800T150-54
Wall Stud	A653 SS Gr33	800S162-54
Chord	A653 SS Gr33	2-600S137-33-BB

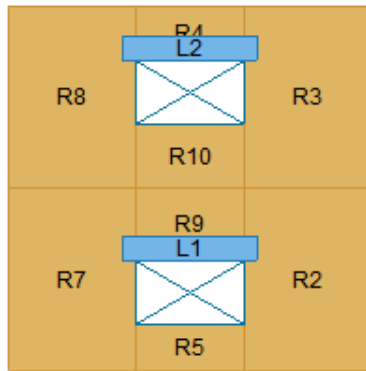

This lists information about the wall, similar to the [Region](#) report and also gives an image of the wall. The image shows the location of hold-downs/straps, regions and headers.

Design Details

DESIGN DETAILS

REGION INFORMATION

Full-Height Region Label	Stud Required Cap	Stud Provided Cap	Stud UC	Stud LC
R2	0.637	0.991	0.643	2
R3	0.318	0.991	0.32	2
R8	0.318	0.991	0.32	2
R7	0.637	0.991	0.643	2

The **Enveloped Results** gives the code checks for all of the controlling elements in the wall and their associated load combinations.

The **Region Information** gives the tabulated results of all of the full-height regions in your wall.

The **Opening Information** simply states that header design cannot be completed with the **Segmented** method. The regions above and below the opening have their shear stiffnesses set to be zero and this causes the header forces to be invalid.

The **Deflection Results** gives both the calculated AISI code deflection (Maximum Region Deflection) and the FE deflection for use as a means of comparison. Because the AISI equations are empirical and take into account many non-elastic considerations such as nail slip, these two values may not be the same.

Region Window

This window gives information for your wall on a region by region basis. Note that only full-height regions of the wall panel will have a region detail report. The **Segmented** method only considers these full height segments in the design of the wall.

The region detail report is split into four portions: [input echo](#), [diagrams](#), [design details](#), and [cross section detailing](#). Note that in RISAFloor the detail reports are less detailed because RISAFloor does not consider lateral forces which RISA-3D does.

Input Echo

Below is the input echo portion of the detail report.

Criteria	Description
Code	Gives the code used to design your wall panel.
Design Method	Gives the design method that was used.
Wall Material	Specifies the CFS type assigned to the entire wall
Panel Schedule	Specifies the sheathing material used to optimize panel selection (set in Design Rules)

Materials	Description
Wall Studs	Specifies the CFS material type assigned to the wall studs
Stud Size	Specifies the member size used for the wall studs
Chord Material	Specifies the CFS material type assigned to the chords (vertical members at both ends of the wall)
Chord Size	Specifies the member size used for the chords (vertical members at both ends of the wall)
Top Plate & Sill	Specifies the CFS material type assigned to the top and sill plates
Top Plate Size	Specifies the member size used for the top plate
Sill Plate Size	Specifies the member size used for the sill plate

Geometry	Description
Total Height	This is the height of the wall panel region
Total Length	This is the length of the wall panel region
Region H/W Ratio	This is the ratio of wall height to length, using the minimum wall height
Cap. Adj (2w/h)	This is an aspect ratio reduction factor for the shear panel strength per AISI S240-15 B5.2.2.1. This factor applies only for wall panels that have an aspect ratio greater than 2 but less than or equal to 4. This factor is applied separately for each full-height region in your wall.
Stud Spacing	This is the optimized stud spacing based on your Design Rules
K	This is the effective length, K Factor used for stud and chord compression design
HD Eccentricity	This is the eccentricity of the hold-down connection. This is based on user input (set within the Design Rules).

Envelope Diagrams

These diagrams show the axial forces, in-plane shear, and in-plane moments of the wall, as well as the maximum and minimum forces and their locations.

Note:

- The diagrams are not actually enveloped.
 - The **Axial** diagram shown is the diagram from the governing load combination for *Stud* design.
 - The **Shear and Moment** diagram is the diagram from the governing load combination for *Shear Panel* design.

Design Details

This portion gives you the capacity and strength values at the section in the wall where the combined check is maximum, as well as the governing load combination. Much of this information is also reported in the **CFS Wall Panel Design** spreadsheets.

Shear Panel

The **Selected Shear Panel** gives the call-out from the shear panel database. The information below it is the information describing the call-out.

The provided capacity of the shear panel is taken from the **Shear Capacity** column of the panel database. This is the adjusted capacity based on tables within the AISI S240-15 and S400-16. The Governing LC explicitly states if the controlling load combination was based on Wind or Seismic. The program does a unity check for all LCs that are being solved, finds the maximum value and reports that information.

This section of the report echoes the database information for the selected shear panel. For more information on these properties refer to [Appendix G-CFS Shear Wall Files](#).

Note:

- The displayed "Shear Capacity" takes the given nominal shear capacity from the design code and multiplies or divides it by the appropriate code factor and aspect ratio factor when applicable.
- A shear panel design will be chosen for the worst-case region in a segmented wall. That panel will then be used for all regions in that wall. The worst-case region is the one that has the highest Shear UC value.
- Because wind and seismic loading allows for different design capacities, the highest shear in the wall may not be the governing shear (if that highest shear was due to wind).

Chords, Studs

The provided capacities of these members are calculated using the standard provisions for tension/compression members. These members are assumed to be fully braced in the weak axis, and unbraced in the strong axis. For more information on the chord force calculations, see the [CFS Wall - Design](#) topic.

Note:

- For chord results, the tension/compression capacity is computed using the reduced cross-sectional properties caused by the hold-down bolt hole.

Deflections

Deflection	
Governing LC = 6	
Total Deflection	0.389 in

The deflection listed in the detail report is based on an approximation from the design code:

AISI Design Deflection

Per the AISI S240-15 North American Standard for Cold-Formed Steel Structural Framing Equation B5.2.5-1:

$$\delta = \frac{2 \cdot v \cdot h^3}{3 E_S \cdot A_C \cdot b} + \omega_1 \cdot \omega_2 \cdot \frac{v \cdot h}{\rho \cdot G \cdot t_{sheathing}} + \omega_1^{\frac{5}{4}} \cdot \omega_2 \cdot \omega_3 \cdot \omega_4 \cdot \left(\frac{v}{\beta}\right)^2 + \frac{h}{b} \cdot \delta_v$$

Refer to the AISI 240-15 standard page 52 for detail definitions for each term in the equation.

The first component of the above equation determines the Bending Component of the deflection.

The second component of the above equation determines the Shear Component of the deflection.

The third component of the above equation determines the Hold-Down Elongation, which causes additional deflection. The delta_v term refers to vertical deformation of the hold-down. This is a user input within the Wall Design Rules.

Note

- This is the theoretical deflection of the wall. This may differ from the deflection of the wall as performed by finite element analysis within RISA. Therefore, this deflection value may not coincide with the reported deflection value in the deflections spreadsheets.

Cross Section Detailing

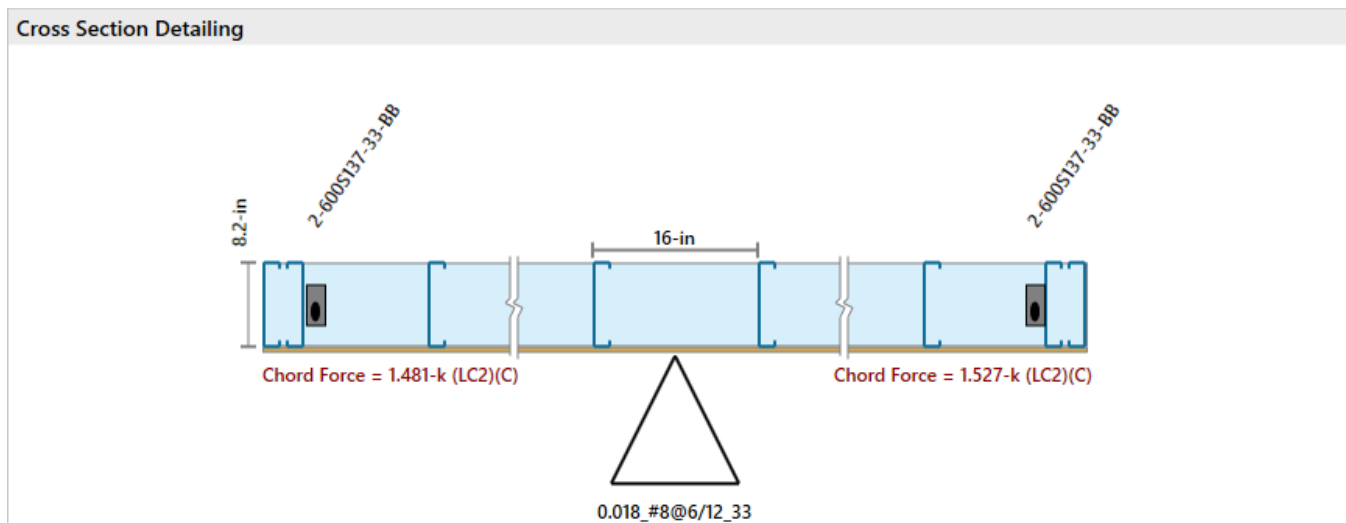

The last section of the detail report consists of the wall detailing information. This information is provided as a visual confirmation of the wall design. The wall thickness, and stud spacing are shown as dimensions. The triangle shows sheathing on one side of the wall, with the abbreviated panel designation. The chord sizes/forces are shown at either end.

Note:

- The graphic will show hold-downs regardless if one is required or not.
- The chord members will always be shown as CS members face-to-face despite what is specified in the Design Rules. This is just a graphical representation of the chord member placement.

Concrete Wall Panel - Design

The concrete wall panel element allows you to easily model, analyze, and design concrete walls for in plane loads for the codes defined below:

- The 2019, 2014, 2011, 2008 and 2005 Editions of ACI 318.
- The 2014 Edition of CSA A23.3.

Note:

- Unless otherwise specified, all code references below are to ACI 318-14.
- Walls designed in RISA meet all of the requirements for Ordinary Concrete Shear Walls.

Here we will explain the concrete-specific inputs and design considerations. For general wall panel information, see the [Wall Panels](#) topic. For concrete wall design rule information, see the [Concrete Wall - Design Rules](#) topic. For concrete wall results interpretation, see the [Concrete Wall Results](#) topic.

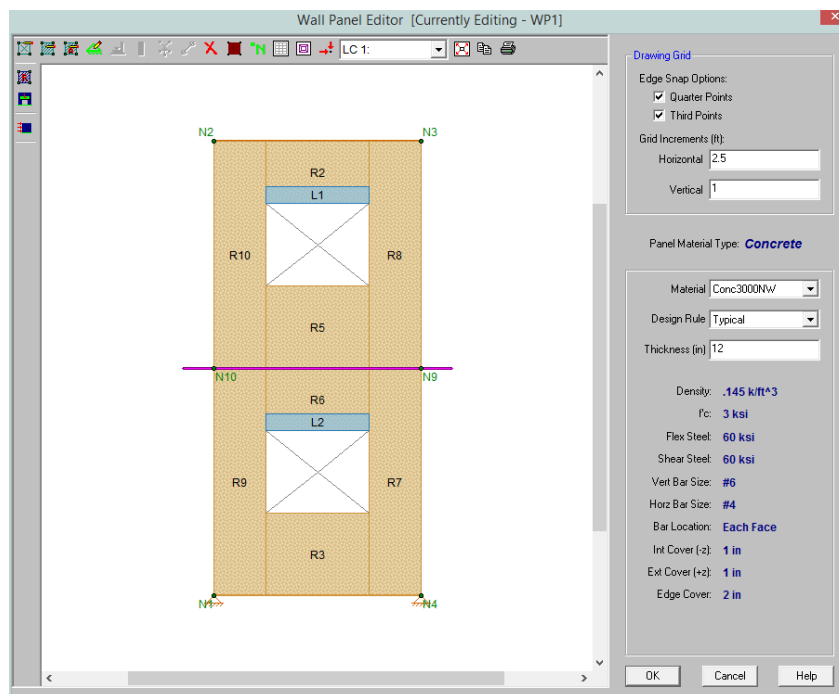

Concrete Wall Input

Double-click on the wall from the model view to open the **Wall Panel Editor**. This dialog displays input information such as Material and Design Rule, as well as gives viewing options for Region and reinforcement display (after solution). Within this dialog you also have control over the application of continuous boundary conditions.



Concrete Wall View Controls

Concrete wall panels have the following view controls:

-  **Toggle Region** display allows you to turn the display of regions on or off.
-  **Toggle Lintel** display allows you to turn the display of lintels on or off.

-  **Toggle Reinforcement** display allows you to turn the display of reinforcement on or off after you have solved your model.
- The **Drawing Grid** allows you to modify your snap options, drawing grid in the wall panel editor.
- The **Material** and **Design Rule** drop down lists allow you to modify these parameters in the wall panel editor.

Concrete Wall Regions

Concrete walls depend on Regions for results presentation. The program automatically creates these regions at solution time. If you have a wall panel with no diaphragms then a single region will be created over the entire wall and you will get a single reinforcement design for the entire wall. If there are diaphragms that pass through your wall panel and/or there are openings in the wall, then the wall will be broken up into multiple regions above and below the diaphragms and around the openings, giving a different reinforcement design for each region.

Within each region, the program will optimize the spacing of bars for strength, spacing and minimum reinforcement considerations of the wall.

From within the **Wall Panel Editor**, you have the option of creating rectangular regions within the concrete wall panel. Regions are used to define reinforcement in different parts of the wall. Each region will be assigned a uniform reinforcement, which may be different than the reinforcement in other parts of the same wall (unless you are using [Group Story](#) option from Wall Design Rules).

If no regions have been drawn on a wall then they will be automatically generated when a solution is performed. To automatically generate regions prior to running a solution, click the **Generate Wall Regions Automatically** button .

To manually draw regions, select the **Create New Regions**  button and use your cursor to select two nodes or grid intersections which make up the diagonal corners of the region. To exit this tool right-click your mouse.

Concrete Design Considerations

ACI 318-14/19 Reinforcement Design

The program will design the reinforcement spacing for you. For this design reinforcement spacing, rho, and strength requirements are considered for design. If specific reinforcement is defined in the [Wall Design Rules](#) spreadsheet then it may be possible for the reinforcement design to not meet code requirements.

Sections 25.2 and Chapter 11 have provisions regarding min/max spacing, required reinforcement ratios, and proper proportioning of wall reinforcement. If your wall does not meet a code requirement the program will give a red warning message in the detail report.

Section 25.2 (General Reinforcement Requirements)

The minimum spacing requirements from Section 25.2.1 are considered for design.

Chapter 11 (Wall Reinforcement Detailing)

The maximum spacing requirements from section 11.7.2.1 and 11.7.3.1 are considered for design.

Note:

- The precast wall spacing requirements of Section 11.7.2.2 and 11.7.3.2 are not considered.

The minimum spacing requirements of Section 11.6.1 are also considered for design. Additionally, the thickness requirement from Section 11.7.2.3 as well as the proportioning and cover checks in that section are also considered.

The program will consider the reinforcement requirements of Section 11.6.2 if the V_u exceeds $0.5 \cdot \phi \cdot V_c$.

ACI 318-11 Reinforcement Design

The program will design the reinforcement spacing for you. For this design reinforcement spacing, rho, and strength requirements are considered for design. If specific reinforcement is defined in the [Wall Design Rules](#) spreadsheet then it may be possible for the reinforcement design to not meet code requirements.

Sections 7.6, 14.3 and 11.9 all have provisions regarding min/max spacing, required reinforcement ratios, and proper proportioning of wall reinforcement. If your wall does not meet a code requirement the program will then give you a red warning message in the detail report.

Section 7.6 (General Reinforcement Requirements)

The minimum spacing requirements from 7.6.1 and the maximum spacing requirements from section 7.6.5 are considered for design.

Section 14.3 (Wall Reinforcement Requirements)

The minimum spacing requirements of Sections 14.3.2 and 14.3.3 and maximum spacing requirements of 14.3.5 are also considered for design. Additionally, the thickness requirement from Section 14.3.4 as well as the proportioning and cover checks of 14.3.4 are also considered.

Section 11.9.8 and 11.9.9 (Shear Reinforcement Requirements for Walls)

The program will consider the reinforcement requirements of Section 11.9.9 if the V_u exceeds $0.5 \cdot \phi \cdot V_c$ (per Section 11.9.8).

CSA A23.3-14 Reinforcement Design

The program will design the reinforcement spacing for you. For this design reinforcement spacing, rho, and strength requirements are considered for design. If specific reinforcement is defined in the [Wall Design Rules](#) spreadsheet then it may be possible for the reinforcement design to not meet code requirements.

Clause 14.1.7.1 and 14.1.8 have provisions regarding wall geometry, min/max spacing, required reinforcement ratios, and proper proportioning of wall reinforcement. If your wall does not meet a code requirement the program will then give you a red warning message in the detail report.

Clause 14.1.7.1 (General Wall Geometry Requirements)

The thickness of the walls shall be not less than the smaller of $l_w / 25$ or $h_u / 25$, but not less than 150 mm.

Clause 14.1.8 (Wall Reinforcement Requirements)

The program considers the provisions for reinforcement diameter (14.1.8.2), number of layers (14.1.8.3), max spacing of reinforcement (14.1.8.4), and min reinforcement ratio (14.1.8.5 & 14.1.8.6).

Reinforcement Placement

The reinforcement is designed to meet spacing, rho, and strength requirements. This design may cause the reinforcement spacing design to not fit in the wall region at the exact spacing designed for. Therefore the program will add bars to the extreme ends of the wall region to take these remainders into account.

The reinforcement layout algorithm works as follows (picture looking down on a cross section of wall):

First the required spacing is calculated and the wall region length is divided by this spacing.

- a. If two bars cannot fit at this spacing, one bar (each face if specified) will be placed at each end of the wall (meeting cover req'ts).
- b. If only three bars fit at this spacing then one bar (each face if specified) will be placed at each end of the wall (meeting cover req'ts) and one bar in the center of the wall.
- c. If more than three bars are required, then reinforcement is filled in uniformly in the center of the wall and an equal remainder is left between the end bar and the second bar. The image below illustrates this (assume symmetry on both ends of the wall).

Note:

- This process is only required for very skinny walls. Almost all walls will fall into **Step c** above.

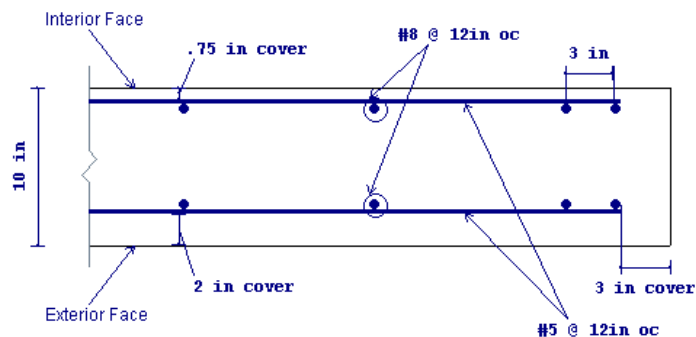
CROSS SECTION DETAILING**Axial Tension**

The axial tensile capacity for a wall assumes all reinforcement is fully developed. The capacity (with no bending interaction) equals:

$$\phi T_n := \phi \cdot n \cdot A_s \cdot f_y$$

where n = number of vertical bars in the wall.

Axial Compression

The axial compressive capacity (with no bending interaction) is taken from equation 10-2.

If CSA A23.3-14 code is selected, Clause 10.10.4 was used to calculate the axial compressive capacity (with no bending interaction).

Note:

- Slenderness is taken into account per section 6.6.4.5. See the [Second Order Effects](#) section below. CSA A23.3-14 uses the same procedure in considering slenderness effect.

Bending**Minimum Required Moment**

ACI 318-14 Section 6.6.4.5.4 (ACI 318-11 Section 10.10.6.5) requires a minimum required moment to be taken into account. Thus, if the value from ACI 318-14 Eq 6.6.4.5.4 (ACI 318-11 Eq 10-17) is greater than the calculated moment demand this value will be used. This is meant to account for a minimum eccentricity of the axial force in the wall. CSA A23.3-14 has similar requirements on minimum required moment as defined in 10.15.3.1.

The design moment may be factored up due to [P-Little Delta](#) effects (see below).

Shear

When ACI 318-19 is selected, V_c is calculated using Equation 11.5.4.3. For wall panels subjected to net axial tension, α_s is calculated using Equation 11.5.4.4.

When other ACI 318 editions are selected, V_c is taken into account using ACI 318-14 Detailed Equations from Table 11.5.4.6 (ACI 318-11 Equations 11-27 and 11-28), where:

- $d = 0.8 \cdot l_{wall}$
- N_u , M_u and V_u are taken at the location of maximum shear demand.

When CSA A23.3-14 are selected, V_c is taken into account using Equation 11.6. The factor β is calculated using Equation 11.11 where:

- The longitudinal strain ϵ_x is calculated using Equation 11.13.
- The equivalent crack spacing parameter s_{ze} is calculated using Equation 11.10.

V_s is taken from ACI 318-14 Equation 11.5.4.8 (ACI 318-11 Equation 11-29). Although V_s is only required if $V_u \geq 0.5 \cdot \phi \cdot V_c$, any minimum reinforcement requirement will be used as V_s and added to the shear capacity.

Note:

- The maximum V_n per ACI 318-14 Section 11.5.4.3 (ACI 318-11 Section 11.9.3) is also checked.
- In ACI 318-14 Section 11.6.2 (ACI 318-11 Section 11.9.9), the l_w term here is taken as the FULL length of the wall, not the length of the region. ACI 318-14 Section 11.5.4.6 (ACI 318-11 Section 11.9.6) take the l_w to be the length of the region.
- In ACI 318-14 Section 11.6.2 (ACI 318-11 Section 11.9.9) the h_w term here is taken as the height of the region.

When CSA A23.3-14 are selected, V_s is taken from Equation 11.7 where the angle of inclination θ is calculated using Equation 11.12.

When ACI 318-19 is selected, V_c is calculated using Equation (c) in Table 22.5.5.1. Note that ACI 318-19 code suggests ρ_w may be taken as the sum of the areas of longitudinal bars located more than two-thirds of the overall member depth away from the extreme compression fiber. Therefore, RISA calculates ρ_w as the sum of the areas of vertical bars on the tension face.

When other ACI 318 editions are selected, the equations from ACI 318-14 Sections 22.5.6.1 and 22.5.7.1 (ACI 318-11 Section 11.2.15 and 11.2.3) is used for V_c .

When CSA A23.3-14 are selected, V_c is calculated in the same way as In-Plane shear section.

Lambda

Lambda is considered differently for the 2005 and newer codes. For ACI 318-05 the program will always consider $\lambda = 0.75$ if the Density of concrete is ≤ 115 pcf and $\lambda = 1.0$ otherwise (ACI 318-05 Section 11.2.1). For the ACI 318-08 and newer codes, the program will use the Lambda value directly from the [Materials](#) spreadsheet.

Deflections

The deflection listed in the detail report is based on the finite element analysis of plate elements. This deflection agrees well with beam theory, thus can be calculated based on beam equations.

Note:

- If you are checking a hand calculation of the in-plane deflections, be sure to include the deflection due to shear and consider the cracked moment of inertia.

Interaction Diagrams

In Plane Wall Interaction Diagram

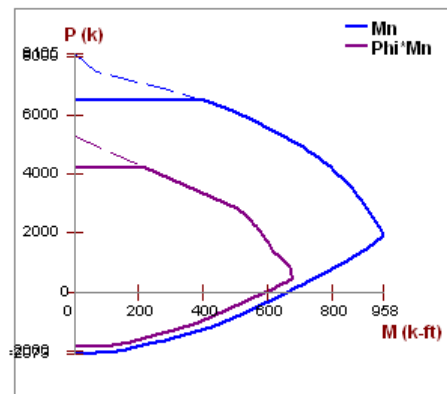

The program uses a concrete solver to create the interaction diagram and uses this diagram to calculate the capacity of a wall/wall region based on the demand axial force and moment. The program computes the code check based on making a straight line through the origin, the moment/axial force demand location, and where that line crosses the interaction diagram curve.

Moment and Axial Force Thresholds

The program will ignore axial forces and moments that are below a certain threshold. If the moment or axial force is deemed to be inconsequential to the code check then the program will simply not include the interaction of that force. There are two thresholds that are considered:

- Axial Force Threshold: If $P_u < 0.01 \cdot f_c \cdot A_g$ for that LC, then the axial force in the wall region will be ignored for code checks for that LC.
- Moment Threshold: If $M_u < 0.01 \cdot d \cdot P_u$ for that LC, then the moment in the wall region will be ignored for code checks for that LC.

These two thresholds allow the concrete solver to work much more efficiently while having little to no effect on code check values.

Second Order Effects

Per ACI 318-14 Section 6.7.1.1 (ACI 318-11 Section 10.10.4) an elastic second order analysis will satisfy code requirements. In RISA this means running a P-Delta analysis to consider secondary moments induced due to the displacement of member ends and a P-Little Delta analysis to account for member curvature effects.

The ACI 318-14 requires that either Section 6.6.4, 6.7 or 6.8 are used for sway frames. The ACI 318-08/11 specifications require that either Section 10.10.3, 10.10.4 or 10.10.5 are used. The ACI 318-05 specification requires that you follow provisions of Section 10.13.

Because a P-Delta analysis (big and little) is a more robust analysis the program requires this analysis for all ACI specifications.

P-Delta

The secondary effects due to the displacements of member ends is taken into account with the inclusion of a P-Delta analysis.

To perform a P-Delta Analysis place a "Y" in the **P-Delta** column of the **Load Combinations** spreadsheet. For more information on this, see [P-Delta](#).

Element Curvature Effects (P-Little Delta)

The design moment (max of demand moment and minimum required moment) must be factored up per Section 10.10.6 if the wall is considered slender.

Slenderness requirements are given in ACI 318-14 Section 6.2.5 (ACI 318-11 Section 10.10.1). The program conservatively only considers ACI 318-14 Equation 6.2.5.b (ACI 318-11 Equation 10-6). Thus, if the KL/r (in either direction) exceeds 22, then the provisions of ACI 318-14 Section 6.6.4.5 (ACI 318-11 Section 10.10.6) are also considered. CSA A23.3-14 uses the same procedure in considering the P-Little Delta effect.

Note:

- The M_2 moment will be calculated separately at each section of the wall vertically, rather than using a single M_2 moment for the entire height of the wall.
- If $P_u > 0.75 \cdot P_c$ the program will fail the wall and not give a code check.
- The moment of inertia (I) in the P_c equation is taken conservatively as $0.25 \cdot I_g$ per ACI 318-14 Section R6.6.4.4.4 (ACI 318-11 Section R10.10.6.2).
- C_m is calculated per ACI 318-14 eq. 6.6.4.5.3a (ACI 318-11 eq. 10-16). User may override this and manually input C_m value in Walls spreadsheet - Advanced tab.
- L_u for the wall is either defined as the full height of wall or story (a story is broken up by diaphragms that cross the wall).
- P-Little Delta is only considered for full story height regions. Non full-height regions will give a note and not do P-Little Delta.
- If the controlling load combination experiences tension, the M_c results will be suppressed and show N/A because tension would actually reduce the amplified moment.
- For more information on this, see [P-Little Delta](#).

Concrete Lintel Considerations

The addition of openings into a wall in the wall panel editor will automatically create a lintel above the opening. It will be symbolized by a blue bar that has the name of the lintel inside of it. The program will produce axial, shear and moment diagrams for the lintel that can be viewed from the [Concrete Wall Detail Report](#) from the Lintel drop-down option. Here we will explain some of the different considerations.

How Lintels are Defined

In RISA-3D the lintel is considered as the entire region directly above an opening (L1 below), even though the blue bar does not cover this entire area.

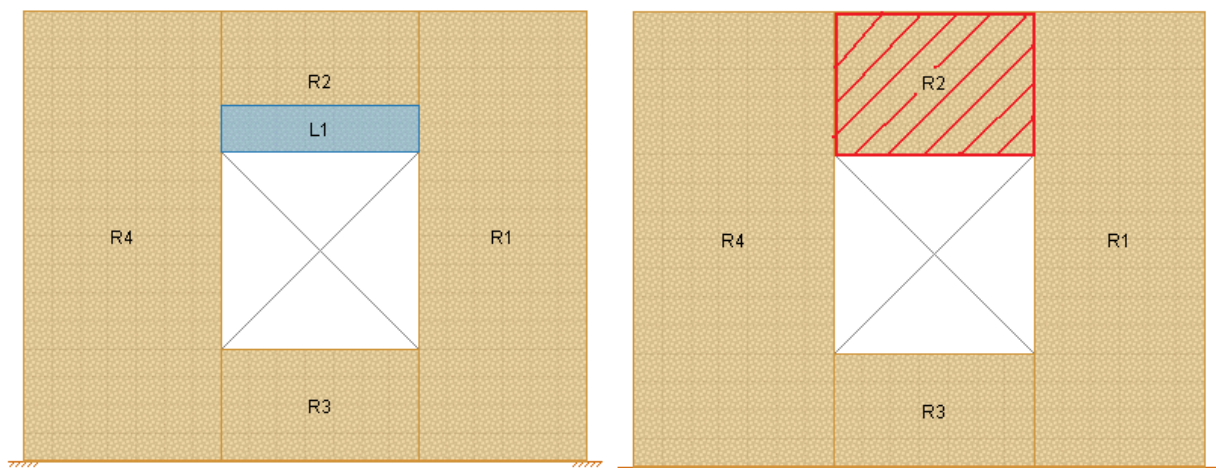

At solution the program will then perform a summation of forces over this entire region and presents the analysis results in the detail report. These results are presented as a "beam" analysis. The program will cut through the entire region vertically multiple times along the length of the region. At each cut the program will calculate the axial, shear and moments. The results from each of these cuts are then combined to form the force diagrams.

Note:

- Keep in mind that the program only reports results in the detail report if there is a region above the opening AND the width of the region matches exactly the width of the opening. Therefore, a region drawn off-center of the opening will not give lintel results.

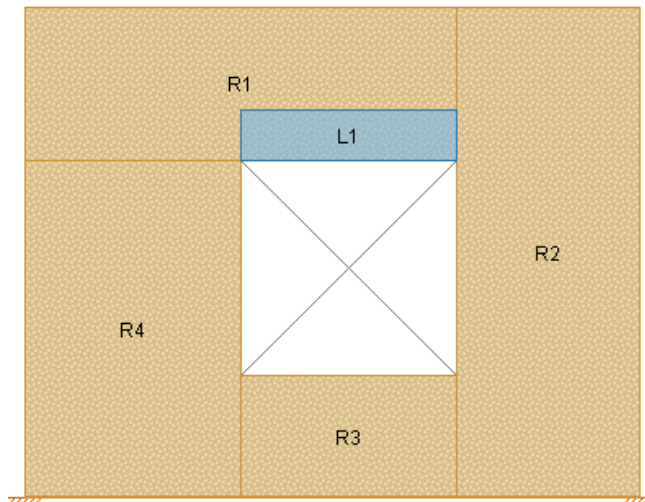

Load Attribution

See the [Wall Panels](#) topic for more information.

Concrete Wall Modeling Considerations

Optimization Procedure

The program will use the [Wall Design Rules](#) and start with the maximum spacing and check that configuration for strength, spacing, and minimum reinforcing requirements. If the max spacing works, then the design is done. If not then the program will reduce the spacing by the spacing increment and then do the same checks. This will occur until a bar spacing is reached to satisfy the code requirements.

Limitations

- Reinforcement development is not considered. All reinforcement is assumed to be fully developed.
- ACI 318-14 Chapter 18 (ACI 318-11 Chapter 21) and CSA A23.3-14 Clause 21 provisions for seismic design are currently not considered in the program.

Concrete Wall - Design Rules

The concrete wall panel element allows you to easily model, analyze, and design concrete walls for in plane and out of plane loads. Here we will explain how concrete design rules work. For general wall panel information, see the [Wall Panels](#) topic. For information on concrete wall design considerations, see the [Concrete Wall - Design](#) topic. For concrete wall results interpretation, see the [Concrete Wall Results](#) topic.

Unity Check

	Label	Max Bending Chk	Max Shear Chk
1	Bearing Wall	1	1
2	Shear Wall	1	1
3	12" Masonry	1	1
4	4" Wood	1	1
5	6" Wood	1	1

Setting a maximum Bending Check (Axial & Bending) or a maximum Shear Check controls the rebar which the program chooses for the wall design. A value of 0.9 denotes that the program may choose a rebar layout that is at 90% of capacity.

Note:

- The same unity check parameters are valid for masonry walls as well. However, these parameters are not considered in wood wall design. For wood walls these values are always assumed to equal 1.0.

Concrete Wall (Rebar) Rules

	Label	Vert Bar Size	Max Vert Bar Space[in]	Min Vert Bar Spa...	Vert Bar Inc[in]	Horz Bar Si...	Max Horz Bar Spa...	Min Horz Bar Spa...	Horz Bar Inc[in]	Group Wall
1	Bearing Wall	#6	18	4	2	#4	18	4	2	<input checked="" type="checkbox"/>
2	Shear Wall	#6	12	2	1	#4	12	2	1	<input type="checkbox"/>
3	12" Masonry	#6	18	4	2	#4	18	4	2	<input type="checkbox"/>
4	4" Wood	#6	18	4	2	#4	18	4	2	<input type="checkbox"/>
5	6" Wood	#6	18	4	2	#4	18	4	2	<input type="checkbox"/>

Vert and Horz Bar Size

These are the vertical and horizontal bar sizes used for reinforcement of the wall.

Note:

- The bar size and spacing is assumed to be the same for each face of the wall. Currently reinforcement must be the same for both faces.

Max/Min Vert and Horz Bar Space

The program will design the reinforcement spacing based on these guidelines. If you want the reinforcement to be at an exact spacing, simply enter that spacing as both the min and max in order to force this spacing.

Horz and Vert Bar Increment

This is the spacing change increment that the program will use for design. If the maximum spacing does not work, the spacing will drop by this increment and be checked again. The program will work its way down until it reaches a spacing that meets all reinforcement requirements.

Group Wall

For walls that have multiple regions, this checkbox allows you to group the reinforcement for the regions in a wall. Thus, the worst case vertical and horizontal reinforcement spacing will be used for all regions in the wall.

Concrete Wall (Cover) Rules

Concrete Wall Panel Cover Parameters								
Unity Check Concrete Wall (Rebar) Concrete Wall (Misc) Masonry Wall Masonry In Masonry Out Masonry Lintel Wood Wall (Studs) Wood Wall (Fasteners)								
	Label	Outer Bars	Location	Int Cover -z[in]	Ext Cover +z[...]	Edge Cover[...]	Transfer In	Transfer Out
1	Bearing Wall	Horizontal	Centered	1	1	2	<input checked="" type="checkbox"/>	<input checked="" type="checkbox"/>
2	Shear Wall	Vertical	Each Face	1.5	1.5	2.5	<input type="checkbox"/>	<input type="checkbox"/>
3	12" Masonry	Vertical	Each Face	1	1	2	<input type="checkbox"/>	<input type="checkbox"/>
4	4" Wood	Vertical	Each Face	1	1	2	<input type="checkbox"/>	<input type="checkbox"/>
5	6" Wood	Vertical	Each Face	1	1	2	<input type="checkbox"/>	<input type="checkbox"/>

Outer Bars

This defines whether the reinforcement mesh has the Horizontal or Vertical bars closest to the face of concrete. If the location is Centered then this defines which bar is nearest the outside face of concrete.

Horizontal

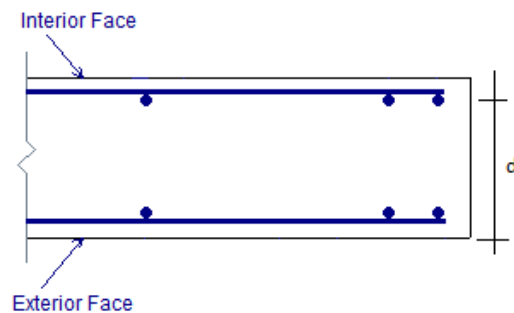

Vertical

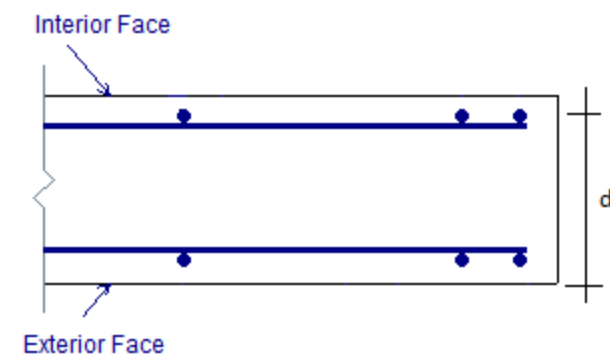

Location

This allows you to locate reinforcement at each face of wall or centered. If the reinforcement is defined as centered then the program places the vertical bar directly at the center of the wall. The horizontal bar is then placed to one side or the other based on the "Outer Bars" designation.

Note:

- The ACI code requires two curtains of reinforcement if the wall is 10" thick or greater, thus the program will give a warning in the results if you configure your wall like this.

Int Cover (-z)

This is the clear cover distance from the interior face of wall to the outer reinforcement. The interior face of the wall is defined by the negative z local axis direction of the wall.

Ext Cover (+z)

This is the clear cover distance from the exterior face of wall to the outer reinforcement. The exterior face of the wall is defined by the positive z local axis direction of the wall.

Edge Cover

This is the "in plane" cover dimension for the outer edges of walls.

Transfer In and Transfer Out

These options allow you to transfer loads from regions above and below openings to adjacent full-height regions. Transfer in is for in plane loads and transfer out is for out of plane loads. Here is an image of a wall:

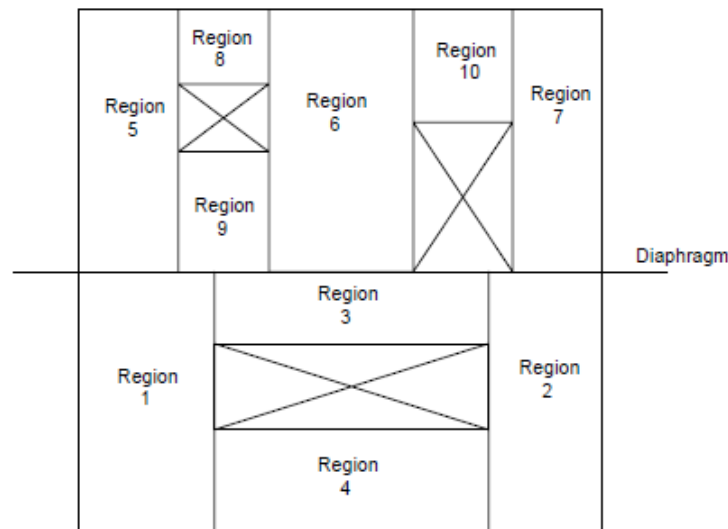

If either of the **Transfer** options are turned on for this wall, then any loading in that plane (in plane or out of plane) for regions above and below openings will have their load transferred into the adjacent regions.

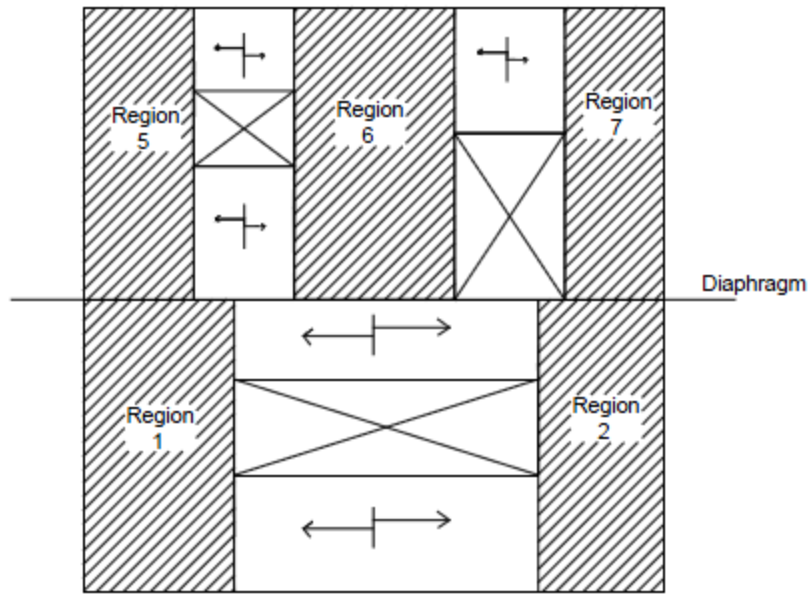

A couple of things to keep in mind with the **Transfer** options:

- This is a design-level tool. That is, there is no stiffness change for the model. The program uses the stiffness of all regions for its stiffness. However, after solution, the forces that have accumulated in the regions above/below openings are moved into the adjacent regions. The adjacent region design will then include these forces.
- Results output will not give any information for these "transferred" regions. Only the regions adjacent to the openings will have results.

Concrete Wall Results

Concrete wall results are presented in the **Wall Panel Design** spreadsheet on the **Concrete** tabs, the **Concrete Reinforcing** spreadsheet on the **Concrete Wall** tab and the detail reports. Results are reported on a region by region basis.

Concrete Wall Spreadsheet Results

The **Wall Panel Design** spreadsheet contains one tab that involve concrete wall design: **Concrete** , . Each tab gives code checks based on the chosen concrete code and can be used as a summary of all of the walls and wall regions in your model. To get detailed information about each region, you can see the [Wall Panel Detail Report](#).

Note:

- Concrete lintel results are not given in the output spreadsheets because the program analyzes them without designing. You must go to the detail report to see lintel analysis results.
- If a wall panel is set to Transfer forces, then regions above and below opening will not have results. See the [Concrete Wall - Design Rules](#) topic for more information.

In Plane

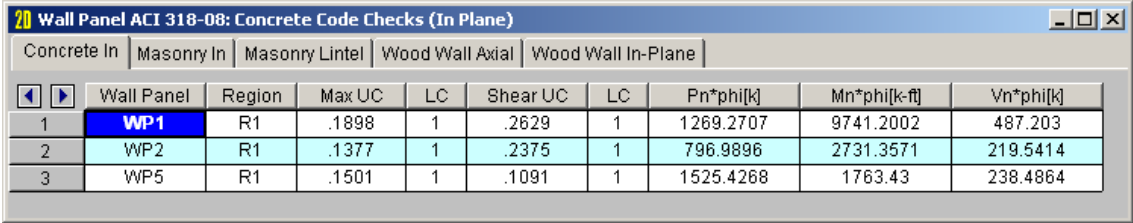

	Wall Panel	Region	Max UC	LC	Shear UC	LC	Pn*phi[k]	Mn*phi[k-ft]	Vn*phi[k]
1	WP1	R1	.1898	1	.2629	1	1269.2707	9741.2002	487.203
2	WP2	R1	.1377	1	.2375	1	796.9896	2731.3571	219.5414
3	WP5	R1	.1501	1	.1091	1	1525.4268	1763.43	238.4864

The **Concrete In** tab provides in plane code checks and capacities relevant to the in plane behavior of the wall.

The **Max UC** entry gives the maximum code check due to axial force plus in-plane bending. The **Shear UC** will show the in plane shear code check. A value greater 1.0 for any of these values would indicate failure.

The **LC** columns report the load combination that produces each of the highest code check values.

The **Pn*Phi** reports the axial capacity of the wall.

Note:

- An NC means that the axial force in the wall is less than the [threshold value](#), so the axial force is not considered.

The **Mn*Phi** reports the calculated in plane moment capacity for the region.

Note:

- An NC means that the bending moment in the wall is less than the [threshold value](#), so the axial force is not considered.

The **Vn*Phi** reports the calculated in plane shear capacity for the region.

Concrete Reinforcing Spreadsheet Results

The **Concrete Wall** tab contains reinforcement results for each region in a concrete wall panel.

Note:

- If a wall panel is set to Transfer forces, then regions above and below opening will not have results. See the [Concrete Wall - Design Rules](#) topic for more information.

Concrete Wall

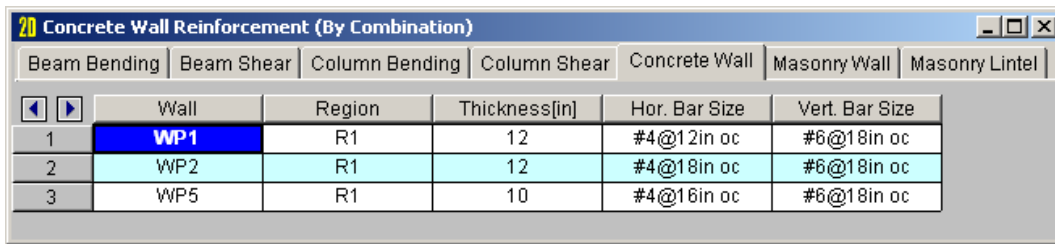

Wall	Region	Thickness[in]	Hor. Bar Size	Vert. Bar Size
1 WP1	R1	12	#4@12in oc	#6@18in oc
2 WP2	R1	12	#4@18in oc	#6@18in oc
3 WP5	R1	10	#4@16in oc	#6@18in oc

The **Concrete Wall** tab displays the thickness, horizontal and vertical reinforcement sizes, and spacing for each region in the concrete wall.



Concrete Wall Detail Reports

The detail reports show the overall geometry, analysis, and design for the individual regions/stories of the wall panel. The report also shows envelope diagrams for the forces and moments in the region.

Three basic types of detail reports are provided: Wall Summary, Region and Opening.

Accessing the Detail Reports and the Specific Windows

Once you have a solved model, the detail reports become available. They are accessible in two ways:

1. If you have the **Wall Panel Design** spreadsheet open, there will be a button at the top of the screen: . This will open up the detail report window.
2. If you are in a graphic view of your model, there is a  button on the Selection toolbar. Clicking this button and clicking on a wall panel will open up the detail report window for that wall panel.



Note:

- If a wall panel is set to Transfer forces, then regions above and below opening will not have results. See the [Concrete Wall - Design Rules](#) topic for more information.

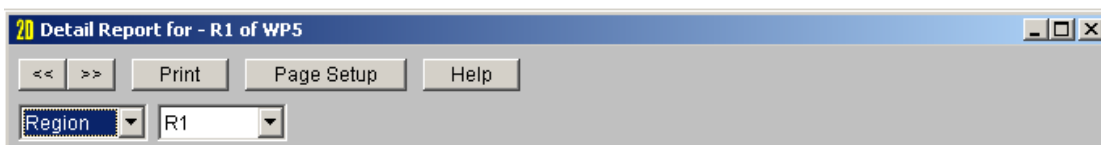
Once the detail report window is open, you will see a dialog area at the top.



These options control the display of the Detail Report:

-   - The arrow buttons allow you to scroll quickly between the different wall panels in your model.
-  - This button will allow you to take a snapshot of the current detail report you are viewing so that it can be added to a report. View the [Printing](#) topic for more information.

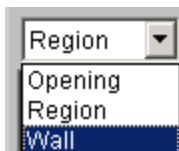

- - The first drop down list allows you to select between individual Region and Opening (Lintel) results and a summary of the entire Wall. Below we will explain the importance of each of these sections.



- - The second drop down list allows you to select between different Regions or Openings within the individual wall panel.

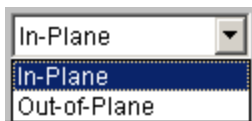

- - If you have selected a Region, then you have the option of whether to view the in plane or out of plane report.

Wall Report

This report gives an overview of the wall, a summary of the controlling code checks and deflection information. This report also displays information about the wall, similar to the [Region Input Echo](#) and also gives an image of the wall. The image shows region locations, wall length and story dimensions, and the nodes that define the corners of the wall panel.

CRITERIA		MATERIALS		GEOMETRY	
Code	: ACI 318-14	Material Set	: Conc3000NW	Total Height	: 16 ft
Design Rule	: Typical	Concrete f _c	: 3 ksi	Total Length	: 10 ft
Loc of r/f	: Each Face	Concrete E	: 3156 ksi	Thickness	: 9.625 in
Outer Bars	: Vertical	Concrete G	: 1372 ksi	Int Cover (-z)	: .984 in
Vert Bar Size	: #5	Conc Density	: .145 k/ft ³	Ext Cover (+z)	: .984 in
Horz Bar Size	: #4	Lambda	: 1	Cover Open/Edge	: 1.968 in
Transfer In?	: No	Conc Str Blk	: Rectangular	K	: 1
Transfer Out?	: No	Vert Bar F _y	: 60 ksi	Use Cracked?	: Yes
Group Wall?	: No	Horz Bar F _y	: 60 ksi	In Icr Factor	: .7
		Steel E	: 29000 ksi	Out Icr Factor	: .35
				Parapet Height	: 4 ft

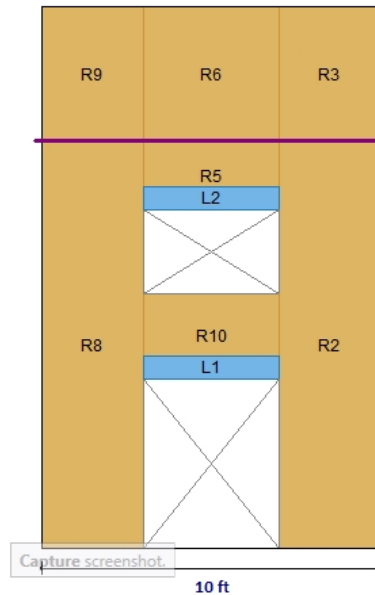

REGION RESULTS

Region	UC Max In Plane		UC Shear In Plane		Delta Max In Plane(in)	
	LC	LC	LC	LC	LC	LC
R1	.077	15	.075	15	.018	15
R2	.048	15	.258	15	.003	15
R3	.1	15	.183	15	0	15
R4	.161	15	.085	15	.018	15

REINFORCEMENT RESULTS

Region	Vertical Reinforcement	Horizontal Reinforcement
	R1	#6@18in oc e.f.
R2	#6@13in oc e.f.	#4@12in oc e.f.
R3	#6@13in oc e.f.	#4@12in oc e.f.
R4	#6@18in oc e.f.	#4@12in oc e.f.

The **Region Results** section gives the tabulated results of all regions in the wall for in plane design axial/bending, shear and deflection for quick reference. You can view the individual region reports to get a more detailed explanation of these values.

The **Reinforcement Results** section gives the reinforcement results for each region in the wall.

Region Report - In Plane

This window gives information for your wall on a region by region basis. The Region detail report is split into five portions: [input echo](#), [diagrams and design](#), [wall section properties](#), [interaction diagrams](#) and [cross section detailing](#).

Note:

- In RISAFloor, the detail reports are less detailed because RISAFloor does not consider lateral forces.

Input Echo

Below is the input echo portion of the detail report.

CRITERIA		MATERIALS		GEOMETRY	
Code	: ACI 318-14	Material Set	: Conc3000NW	Total Height	: 12 ft
Design Rule	: Typical	Concrete f _c	: 3 ksi	Total Length	: 3 ft
Loc of r/f	: Each Face	Concrete E	: 3156 ksi	Thickness	: 9.625 in
Outer Bars	: Vertical	Concrete G	: 1372 ksi	Int Cover (-z)	: .984 in
Vert Bar Size	: #5	Conc Density	: .145 k/ft ³	Ext Cover (+z)	: .984 in
Horz Bar Size	: #4	Lambda	: 1	Cover Open/Edge	: 1.968 in
Vert Bar Spac	: 16 in	Conc Str Blk	: Rectangular	K	: 1
Horz Bar Spac	: 16 in	Vert Bar F _y	: 60 ksi	Use Cracked?	: Yes
Group Wall?	: No	Horz Bar F _y	: 60 ksi	I _{cr} Factor	: .35
		Steel E	: 29000 ksi	Parapet Height	: 4 ft

Criteria	Description
Code	Gives the code used to design the wall.
Design Rule	Gives the design rule used to design reinforcement and cover for the wall.
Loc of r/f	States whether reinforcement is defined at each face of the wall or centered.
Outer Bars	States whether the outer bar in the wall is vertical or horizontal.
Bar Size	States the bar size for both horizontal and vertical reinforcement
Bar Spacing	States the bar spacing for both horizontal and vertical reinforcement
Group Wall?	States whether the regions in the wall are grouped or not. See the Concrete Wall - Design Rules topic for more information.

Materials	Description
Material Set	States the Material used for the design of the wall.
Concrete f _c	States the compressive strength of the concrete.
Concrete E	States the modulus of elasticity of the concrete.
Concrete G	States the shear modulus of the concrete.
Conc Density	States the unit density of concrete used for self-weight calculations.
Lambda	States the lightweight concrete factor for shear design.
Conc Str Blk	States whether a rectangular (Whitney's) or parabolic stress block was used.
Bar F _y	States the reinforcement strength for both vertical and horizontal bars
Steel E	States the modulus of elasticity for reinforcement.

Geometry	Description
Wall Dimensions	States the height, length, and thickness of the wall panel region.
Cover Dimensions	States the interior, exterior, and edge reinf. cover dimensions.
K	States the effective length factor which is used in determining slenderness of the wall.
Use Cracked?	States whether a wall is considered to be cracked or not. Defines whether or not to use cracking in the determination of the moment of inertia.
I _{cr} Factor	States the factor that I _{gross} is multiplied by to get the cracked moment of inertia. This defaults to 0.7 for in plane and 0.35 for out of plane.

Diagrams and Design

ENVELOPE DIAGRAMS

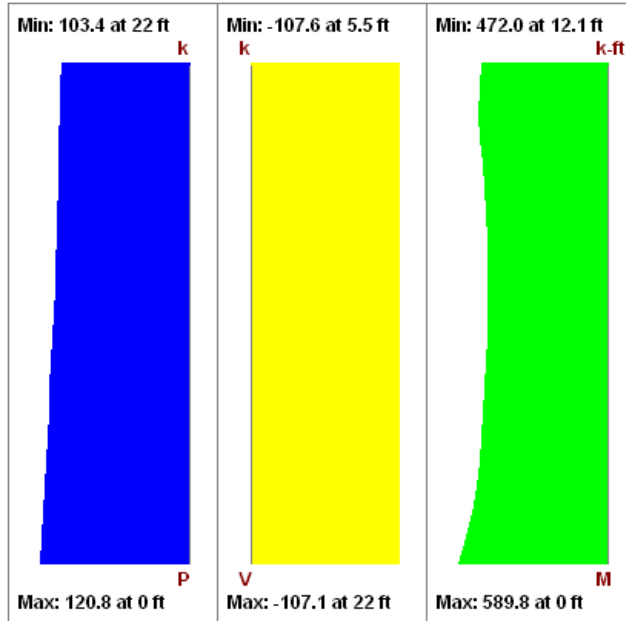

ACI 318-08 Code Check

AXIAL/BENDING DETAILS

UC Max	: .039	
Location	: 0	ft
Gov Pu	: 0	k
phi*Pn	:	k
Gov Mu	: 589.8284	k-ft
phi*Mn	: 15113.0342	k-ft
phi eff.	: .9	
Gov LC	: 2	

SHEAR DETAILS

UC Max	: .1533	
Location	: 3	ft
Gov Vu	: -107.6151	k
phi*Vn	: 702.0642	k
Vnmax	: 1051.6273	k
Vc	: 347.037	k
Vs	: 589.0486	k
Gov LC	: 2	ft

DEFLECTION DETAILS

Delta max	: .0092	in
Deflection Ratio	: H/10000	
Location	: 12	ft
Gov LC	: 2	

Envelope Diagrams

These diagrams show the axial forces, in-plane shear, and in-plane moments of the wall region, as well as the maximum and minimum forces and their locations. The results give an envelope solution of all load combinations.

Because the enveloped results displayed are always the maximum values and because axial and bending forces are checked per their combined effects, the forces in the envelope diagrams won't necessarily be the forces that the wall region is designed to. For example, if there is a high bending moment at the top of a wall region and a high axial force at the base of the wall region, the program will do a check *at each location up the wall region, considering the shear and moment at that location for THAT load combination*. Thus, the maximum axial force given at the location of maximum bending may NOT be the axial force for the LC that produced the maximum bending.

Code Check Summary

This portion of the report gives the capacity and strength values at the section in the wall region where the combined check is maximum, as well as the governing load combination. Much of this information is also reported in the **Concrete Wall Panel Design** spreadsheets.

Axial/Bending Details

The axial and bending capacity are based upon an interaction diagram for the wall region. See below for interaction diagram information. The program computes the code check based on making a straight line through the origin, the moment/axial force demand location and where that line

crosses the interaction diagram curve.

Shear Details

The shear details section gives the shear demand required in the wall region. The in plane shear strength of the concrete and steel are listed separately, along with the code-prescribed maximum allowed shear. For more information on shear capacity of concrete walls, see the [Concrete Wall - Design](#) topic.

Deflections

The deflection listed in the detail report is based on the finite element analysis of plate elements. This deflection agrees well with beam theory, thus can be calculated based on beam equations.

Note:

- If the deflection ratio is larger than $L/10000$, then $L/10000$ will be reported.
- If you are checking a hand calculation for in plane deflections, be sure to include the deflection due to shear and consider the cracked moment of inertia.

Wall Section Properties

WALL SECTION PROPERTIES

Total Length	: 20	ft	r	: 69.282	in	As Provided (H)	: 14.7262	in ²
A	: 2400	in ²	KL/r	: 2.078		rho Provided (H)	: .0061	
I _{gross}	: 1.152e+7	in ⁴				As min (H)	: 5.28	in ²
I _{cracked}	: 8.064e+6	in ⁴				rho min (H)	: .0022	
Cracked Mom, M _{cr}	: 3286.3353	k-ft				As Provided (V)	: 34.5575	in ²
						rho Provided (V)	: .0144	
						As min (V)	: 3.6	in ²
						rho min (V)	: .0015	

This section reports the properties used to calculate the wall capacities. The reinforcement details (minimums and provided area) are reported.

Slender Wall Considerations (P-Little Delta)

SLENDER BENDING SPAN RESULTS

KL/r out	C _m out	Lu out (ft)	P _c (k/ft)	deltaNS	M ₂ (k-ft/ft)	M ₂ min (k-ft/ft)	M _c out (k-ft/ft)
69.282	.8969	20	233.6135	2.5348	9.0571	9.0571	-22.9578

SLENDER BENDING SPAN RESULTS

KL/r in	C _m in	Lu in (ft)	P _c (k)	deltaNS	M _{act} (k-ft)	M ₂ min (k-ft)	M _c in (k-ft)
3.6803	.6722	8	0	N/A	0	0	N/A

ACI 318-14 Section 6.6.4.5 (ACI 318-11 Section 10.10.6) considers moment magnification of non-sway frames. This is essentially the P-little delta effect in the form of an amplified moment due to the effects of element curvature, M_c . This moment replaces the actual demand moment in design checks. For more information on this see the [Concrete Wall - Design](#) topic.

Note:

- M_{act} is the actual demand moment in the wall from analysis. The program compares this to the M_{2min} moment and uses the maximum as the M_2 moment.

- Since the moment can be different positive or negative for out of plane bending, the program will provide an Interior and Exterior calculation in this case.
- If the controlling load combination experiences tension, the Mc results will be suppressed and show N/A because tension would actually reduce the amplified moment.

Interaction Diagrams

In Plane Wall Interaction Diagram

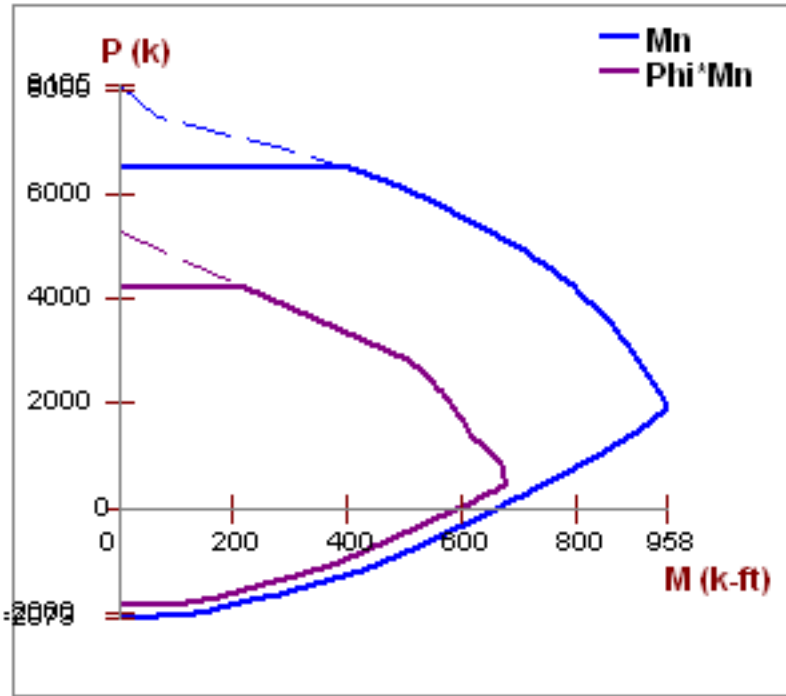

The program uses a concrete solver to create the interaction diagram and uses this diagram to calculate the capacity of each wall region based on the demand axial force and moment. The program then computes the code check based on making a straight line through the origin, the moment/axial force demand location and where that line crosses the interaction diagram curve.

Cross Section Detailing

CROSS SECTION DETAILING

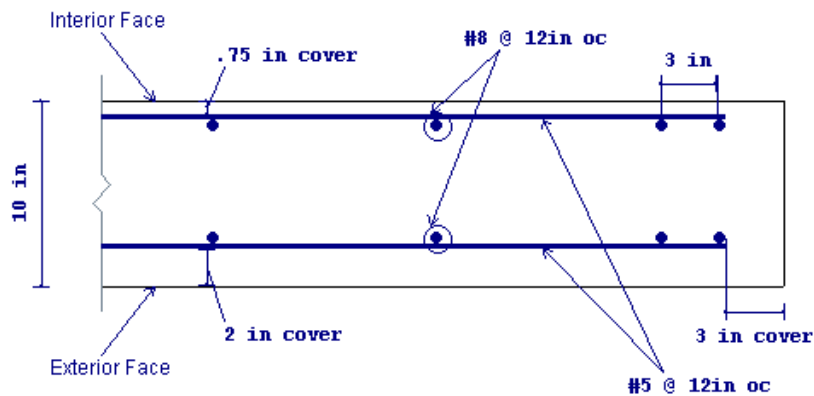

The last section of the detail report consists of a graphic cross-sectional view of the wall. This view gives cover dimensions, reinforcement size and spacing, and the wall thickness for placement verification.

Concrete Lintel Report

Lintels - Criteria / Materials / Geometry

The first section of the detail report echoes back the basic input parameters (Criteria, Materials, Geometry) entered by the user. An example is shown below:

CRITERIA		MATERIALS		GEOMETRY	
Code	: ACI 318-08	Material Set	: Conc3000NW	Total Height	: 3.5 ft
Design Rule	: Typical	Concrete fc	: 3 ksi	Total Length	: 6 ft
Loc of r/f	: Each Face	Concrete E	: 3156 ksi	Thickness	: 12 in
Outer Bars	: Vertical	Concrete G	: 1372 ksi	Int Cover (-z)	: 1 in
		Conc Density	: .145 k/ft³	Ext Cover (+z)	: 1 in
Vert Bar Size	: #6	Lambda	: 1	Cover Open/Edge 2	: in
Horz Bar Size	: #4	Conc Str Blk	: Rectangular		
		Vert Bar Fy	: 60 ksi		
Valid Region	: R2	Horz Bar Fy	: 60 ksi		
		Steel E	: 29000 ksi		

Since the lintel is not being designed, much of this information is not used but is displayed for reference.

Information	Description
Valid Region	This is the region that the forces are being considered over. The program will sum forces of the region directly above the opening and the forces given in the detail report come from this portion of the wall.
Total Height	This is the height of the region above the opening that forces are being reported for.
Total Length	This is the width of the opening that the lintel is spanning.
Thickness	This is the thickness of the wall.
Other Information	All of the other information is general information for the overall wall.

Lintel Detail Reports - Diagrams

The next section of the detail report provides the enveloped axial, shear and moment diagrams over the length of the lintel. These can be viewed for both in and out of plane forces and are the "beam" forces for the lintel.

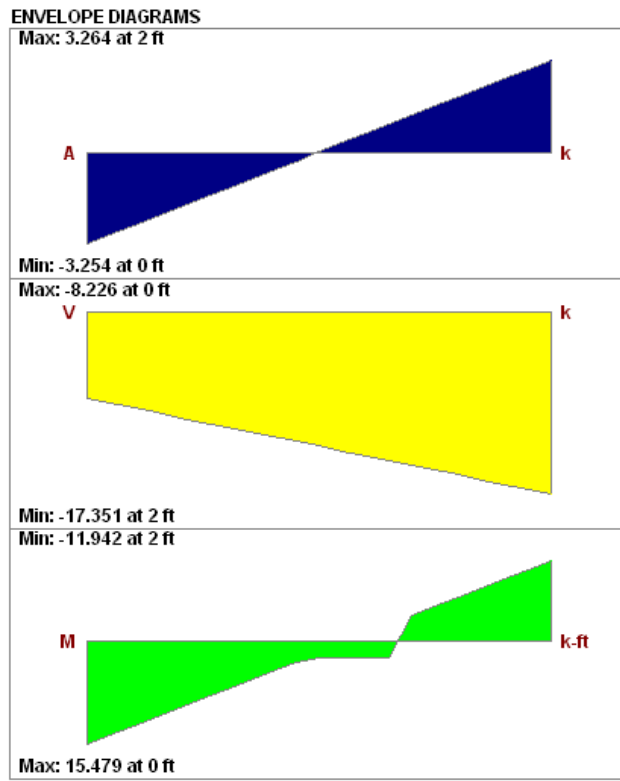

Masonry Wall Panel - Modeling

The masonry wall panel element allows you to easily model, analyze and design masonry walls for in plane loads. Here we will explain the masonry specific inputs and procedures for modeling. For general wall panel information, see the [Wall Panels](#) topic. For information on masonry design rules, see the [Masonry Wall - Design Rules](#) (this is where you can define block thickness and self-weight). For masonry calculation considerations and code references, see the [Masonry Wall - Design](#) topic. For masonry wall results interpretation, see the [Masonry Wall Results](#) topic.

Note:

- All code references in this topic refer to the **TMS 402-16** specification unless noted otherwise.

Masonry Wall Input

The **Wall Panel Editor** gives some specific information and options for modeling/analysis of masonry walls.

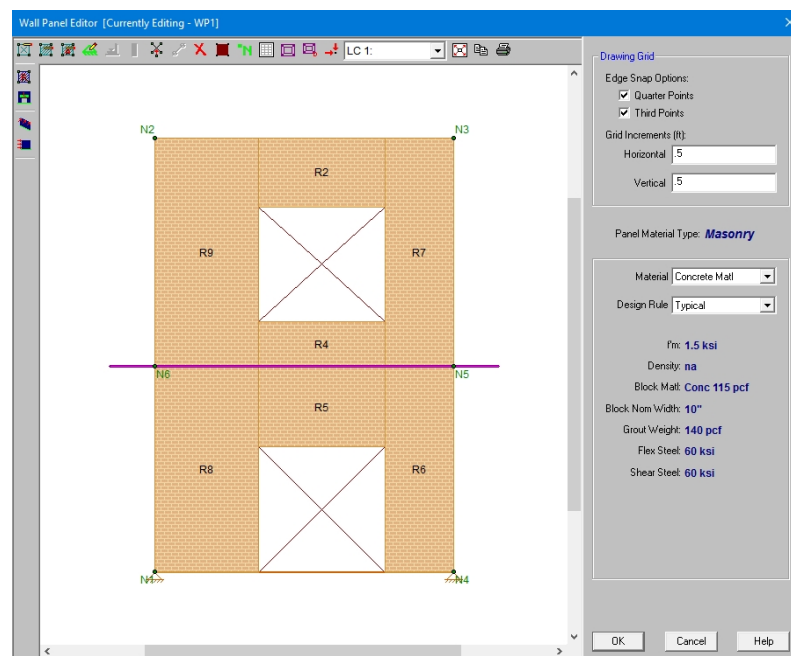

Masonry View Controls

Masonry Wall Panels will have the following view controls:



Toggle Region Display allows you to turn the display of regions on or off.



Toggle Lintel Display allows you to turn the display of lintels on or off.



Toggle In Plane Reinforcement allows you to turn the display of in plane reinforcement on or off after you have solved your model.

Creating Openings in Masonry with Lintels

Within the **Wall Panel Editor**, you have the option of adding rectangular openings to masonry wall panels. To draw an opening, select the **Openings** button and then select two nodes or grid intersections which make up the two diagonal corners of your opening. When an opening is drawn a lintel is automatically created above the

opening. To view or edit the properties of a masonry lintel, double-click inside the boundary of the drawn opening. This will bring up the Editing Properties window for that particular lintel.

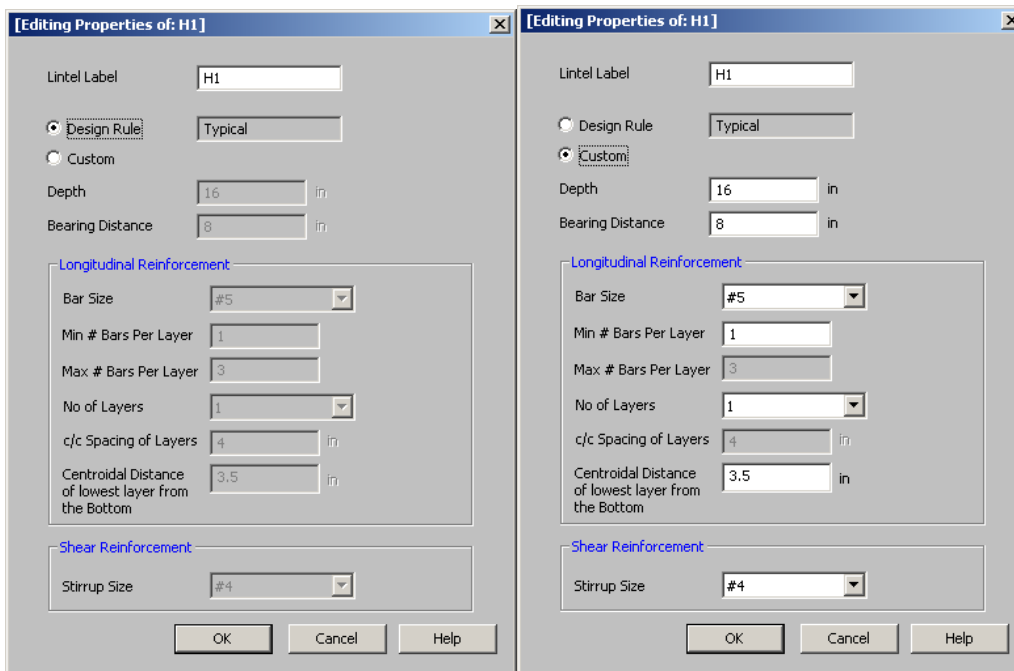

This window will show the design options set in the [Wall Design Rules - Lintel](#) spreadsheet to design/analyze your lintel. If you have multiple lintels in a wall and want a specific design that differs from the other lintels, then you can choose the **Custom** option. When using the custom option, the program will now use all of the information set in the Lintel Editor and will disregard any information given by the design rule.

Here we will walk through the different input options available for designing/analyzing lintels:

Depth - This is the depth of your lintel.

Bearing Distance - This is the bearing length at either end of the lintel. This is used to calculate the effective length of the lintel.

Bar Size - This is the reinforcement size you wish to use for your main reinforcing in the lintel.

Bars Per Layer - This is the number of bars you wish to have in a given layer of reinforcement. There is also an option to have this value optimized based on geometry of the section and also the number of layers that you have defined.

Number of Rebar Layers - This is an option if you need multiple layers of reinforcement in the lintel.

c/c Spacing of Layers - This is the distance between layers (if there is more than one).

Centroidal Distance of lowest layer from the Bottom - This value is used to calculate the "d" value for the lintel.

Stirrup Size - This is the size of stirrup that will be added to the lintel if required.

Note:

- When inputting bar sizes for your lintels, the program will not allow you to place reinforcement that will not actually fit into the lintel because of width constraints. We use the actual dimensions of the block, the face-shell thickness for the given block chosen and use a 1/2" clear cover between reinforcement and the block per section 6.1.3.5.

Masonry Regions

Within the Wall Panel Editor, you have the option of creating rectangular regions within the masonry wall panel. Regions are used to define reinforcement in different parts of the wall. Each region will be assigned a uniform reinforcement, which may be different than the reinforcement in other parts of the same wall.

If no regions have been drawn on a wall then they will be automatically generated when a solution is performed. To automatically generate regions prior to running a solution, click the **Generate Wall Regions Automatically** button .

To manually draw regions, select the **Create New Regions**  button and use your cursor to select two nodes or grid intersections which make up the diagonal corners of the region. To exit this tool right-click your mouse.

To view or edit the properties of a masonry region, double-click inside the boundary of the drawn region. This will bring up the Editing Properties window for that particular region.

The information is populated from the Wall Design Rules spreadsheet for masonry. For more information see the [Masonry Wall - Design Rules](#) spreadsheet on setting this up.

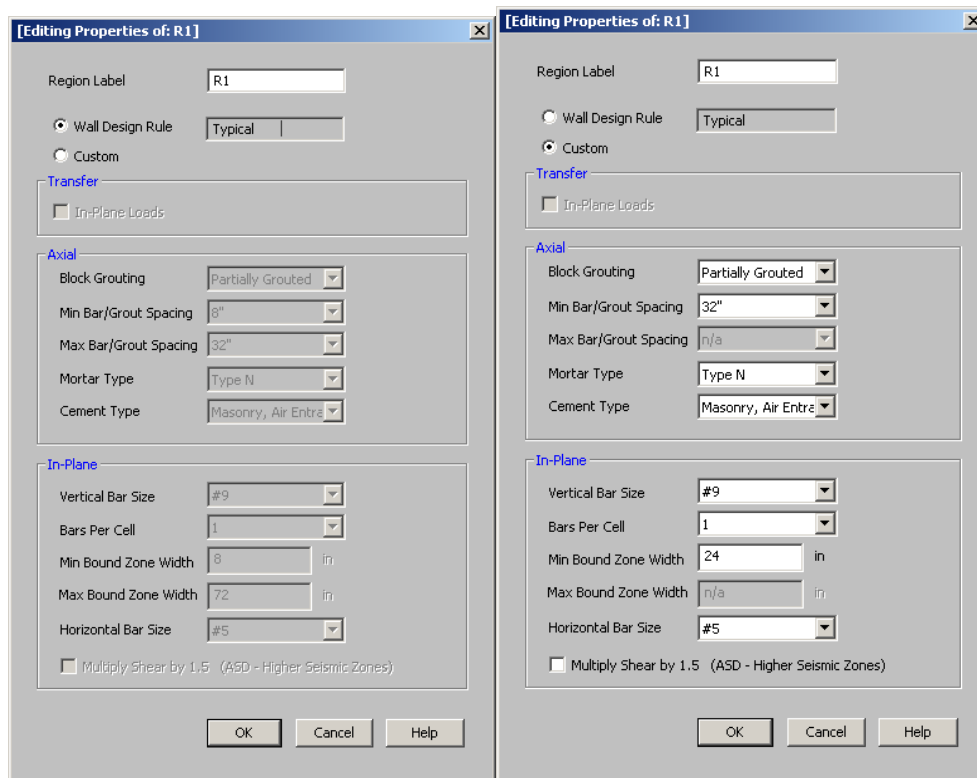

The image displays two side-by-side screenshots of the "Editing Properties of: R1" dialog box. Both windows show the same settings for Region Label (R1), Wall Design Rule (Typical), and Custom options. The "Transfer" section has "In-Plane Loads" unchecked. The "Axial" section includes "Block Grouting" (Partially Grouted), "Min Bar/Grout Spacing" (8" and 32"), "Max Bar/Grout Spacing" (32" and n/a), "Mortar Type" (Type N), and "Cement Type" (Masonry, Air Entr). The "In-Plane" section includes "Vertical Bar Size" (#9), "Bars Per Cell" (1), "Min Bound Zone Width" (8 in and 24 in), "Max Bound Zone Width" (72 in and n/a), and "Horizontal Bar Size" (#5). A checkbox for "Multiply Shear by 1.5 (ASD - Higher Seismic Zones)" is present and unchecked in both. The left window has "OK", "Cancel", and "Help" buttons at the bottom.

In most cases this Region Editor would only be used as a viewer. If, however, you want to change the reinforcement for a region within the wall to make it different than the Wall Design Rules, you can use the **Custom** option. When using the custom option the program will now use all of the information set in the Region Editor and will disregard any information given by the design rule.

Note:

- For models created with version or earlier ALL regions will come in set to Custom, bringing over the information exactly as it comes from the existing model. For all newly created models in version or later the regions will default to the wall design rule.

Within this dialog you can specify the properties which will be used for the design of the region. The program can optimize the bar spacing and the boundary zone width based on code checks. The block size, reinforcing strength and the method of self-weight calculation are defined in the Design Rules under the [Masonry Wall](#) tab.

Here we will walk through the different input options available for designing/analyzing regions:

Transfer - This is an option as to whether or not you want this region to transfer In Plane Loads. If you check these transfer options, the program will dump those loads above and below an opening into the adjacent regions for design.

Note:

- These transfer options are only available when you have defined a region above or below an opening.
- If you do not choose to check these transfer options you will see design results for regions above and below openings.

Axial - Allows you to define properties of a region based on axial forces.

- **Block Grouting** - Allows you to define how you want your wall grouted. If you choose "Partially Grouted" the program will optimize the grout spacing with the Bar/Grout Spacing
- **Bar/Grout Spacing** - This allows you to define the bar/grout spacing. If you have the "Optimize" box checked, the program will optimize the reinforcement spacing based on code checks.
- **Mortar Type** - Allows you to specify the type of mortar to design for.
- **Cement Type** - Allows you to specify the type of cement to design for.

In-Plane - Allows you to define properties of a region based on in-plane forces.

- **Vertical Bar Size** - Allows you to define vertical bar size for the boundary zones.
- **Bars Per Cell** - Allows you to define one or two bars per cell.
- **Boundary Zone Width** - The user must define a boundary zone width but RISA will optimize the width if the "Optimize" box is checked.
 - **Note:** If you have the optimize checkbox selected, the program will optimize the boundary zone width based on code checks.
- **Horizontal Bar Size** - Allows you to define horizontal bar size to be used if horizontal reinforcing is required.
- **Multiply Shear by 1.5** - This is an option that may be required in high seismic zones. This option is available per section 7.3.2.6.1.2.

Merge Lintels

When an opening is drawn in a masonry wall panel, you will notice that a lintel beam region is automatically created above the opening. If you have multiple openings, you may want to merge the individual lintels into one.

To do this, select the Merge Lintels  button. If you have two lintels you want to merge, then click within each of the openings to merge them into one. If you have multiple lintels that you want to merge, click inside of the two openings that define the ends of the merged lintel that you want. You will see that this merges your multiple openings into one. To exit out of this tool right-click your mouse.

When merging lintels, the top edges of the lintels have to be identical. If, once you have merged lintels, you delete one of the openings the entire lintel will be deleted. At that point, you have to delete any openings left in the wall that don't have a lintel over them.

Masonry Wall Optimization

The program will optimize masonry walls and lintels based on the required demand forces. The program can optimize:

- Vertical bar/grout spacing for axial design.
- Boundary zone widths for in plane flexural design.
- Horizontal bar spacing for in plane shear design.
- Reinforcement bars for lintel flexural design.

Of these optimizations, the only one that substantially modifies the stiffness of the wall is the vertical bar/grout spacing. To properly adjust the stiffness requires an iterative solution that updates the stiffness of the model. This includes updating the strength properties of the wall as well as the stiffness. This optimization/iteration can be done automatically (by choosing **Yes**) or can be done manually (by choosing **No**) in the [Model Settings - Solution](#) tab.

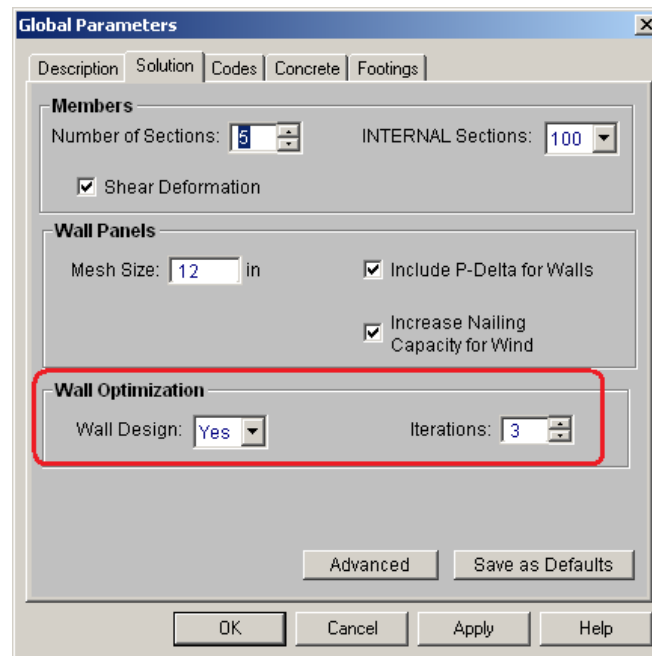

To update the stiffness portion of the wall, the program must re-solve your model with these updated stiffnesses as this will change the distribution of forces through the model. By choosing **Yes** you are telling the program to re-solve automatically. Thus, the program will start with its initial stiffness parameters and solve the model. It will then optimize the wall to meet strength criteria. Another solution will then be run with the new stiffnesses and the program will again optimize the wall to meet strength criteria. This procedure will continue to occur until you reach the number of **Iterations** set or until all wall panel results match those of the previous solution.

By choosing **No** the program will only run the solution once and the results will be based on the original configuration. You can then manually optimize your walls using the [Suggested Design](#) spreadsheet.

After the solution is run (with or without optimization) the design results are based on the stiffness used in the last iteration (by stating **No** a single iteration is run). The program will then compare the design of the last iteration with the stiffness used in that last iteration. If the two are the same, the results shown are the final results. If the two are not the same, the program will then provide these two different results in the **Suggested Design** spreadsheet.

The program will always present results in the output that coincide with the stiffness used in the final solution.

Note:

- The updating of the stiffness for the model is only required for the vertical bar/grout. Thus, boundary zone widths, horizontal shear reinforcement and lintel reinforcement are optimized automatically.

Suggested Design

Wall Panel	Current Spacing[in]	Suggested Spacing[in]	Use Suggested?
1 WP1	24	8	<input checked="" type="checkbox"/>

In the **Suggested Design** spreadsheet you will get a list of wall panels in your model that are not yet fully optimized, showing the vertical bar and/or grout spacing of the last iteration (Current Spacing) and the program optimized spacing (Suggested Spacing). From here you have the ability to **Use Suggested?** which means that you want to re-run the solution with the Suggested Spacing. You can choose this for each wall panel individually.

Once you have these checkboxes checked appropriately, press the  button. After this, the stiffness matrix is re-formulated and may cause some redistribution of loads through the model. Because of this, the Suggested Spacing may also update and you may need to **Use Suggested?** multiple times to converge on a solution.

Note:

- If the wall does not show up in the Suggested Design spreadsheet, then the current wall panel settings used are the optimal ones.
- For more information on wood wall optimization see the [Wood Wall - Design](#) topic.
- For more information on member optimization see the [Design Optimization](#) topic.
- Concrete walls do not show up here because the reinforcement optimization does not affect the stiffness of the wall.

Lintels

For masonry lintels you must input the dimensions, bar size and number of layers of bars for the lintel, but are given the option of optimizing how many bars are in a given layer. If you provide a max/min number of bars in the [Wall Design Rules - Masonry Lintel](#) tab then the program will optimize the number of bars in a layer. Because this is just a change in reinforcement, this is an automatic optimization that does not require an iterative solution.

Lintel Reinforcement Placement Check

The program will do a check to see that the reinforcement in the lintel will fit properly. The available width for reinforcing in the lintel is based on the width of block, thickness of grout between the block and the reinforcement, and it assumes there will be a double-leg stirrup.

$$W_{available} := W_{Block} - 2 \cdot t_{faceshell} - 2 \cdot t_{grout} - 2 \cdot d_{bstirrup}$$

where

- t_{grout} = 0.5 in (per Section 6.1.3.5 of ACI 530-13; the program assumes coarse grout)
- $dbstirrup$ = diameter of stirrup (from the [Wall Design Rules - Masonry Lintel](#) tab)

Note that we use a minimum bar spacing equal to the minimum of either d_b or 1".

Regions

For masonry regions, there is one option for optimizing. For in-plane design, the boundary zone width will be optimized for strength. The spacing of reinforcement/grouting affects the overall stiffness of the wall thus you must iterate your solution to update this spacing. The boundary zone design affects the overall stiffness very little, thus this is an automatic optimization that does not require an iterative solution. If you provide a min/max

boundary zone width in the [Wall Design Rules - Masonry In](#) tab, then the program will optimize the boundary zone width.

Limitations

- For areas of masonry wall panels that are not defined as a region, the stiffness of the wall is assumed to be that of an ungrouted masonry wall and the weight of the wall is assumed to be that of a fully grouted wall.
- Masonry has specific requirements regarding the spreading out of concentrated loads at certain angles and for certain depths (Section 5.1.3). These provisions are not considered in RISA, as the finite element mesh stiffness is what determines load path. See the [Wall Panels - Load Attribution](#) topic for more information.

Masonry Wall Panel - Design

The masonry wall panel element allows you to easily model, analyze and design masonry walls for in plane loads for these specific codes:

- The 2016 TMS 402 ASD and 2013, 2011, 2008, 2005, 2002 and 1999 Editions of ACI 530 ASD
- The 2016 TMS 402 Strength and 2013, 2011, 2008, 2005, 2002 and 1999 Editions of ACI 530 Strength
- The 1997 edition of the UBC for ASD and Strength

Here we will explain the calculation concepts and code references used in the program. For general wall panel information, see the [Wall Panels](#) topic. For information on masonry design rules, see the [Masonry Wall - Design Rules](#) (this is where you can define block thickness and self-weight). For masonry wall modeling procedures, see the [Masonry Wall - Modeling](#) topic. For masonry wall results interpretation, see the [Masonry Wall Results](#) topic.

Note:

- All code references in this topic refer to the **TMS 402-16** specification unless noted otherwise.
- References will be made to RMEH and NCMA. For more information on these designations, see the [Masonry Wall - Design Rules](#) topic.
- Walls designed in RISA meet all of the requirements for Ordinary Masonry Shear Walls except for the Minimum Reinforcement requirements of TMS 402-16 Section 7.3.2.3.1. That provision should be checked by hand outside of RISA.

Shear Design - In Plane ASD

In Plane Shear Stress, f_v

This stress is calculated from Equation 8-24:

$$f_v := \frac{V}{A_{nv}}$$

where:

- V = Total in plane shear in the wall region
- A_{nv} = net shear area

In RISA A_{nv} is defined as follows:

$$A_{nvRMEH} := Eq_{solidthickness} \cdot d_{inplane}$$

$$A_{nvNCMA} := \frac{A_{nvNCMAperfoot}}{\left(\frac{12 \text{ in}}{1 \text{ ft}}\right)} \cdot d_{inplane}$$

where:

- $d_{inplane}$ = distance from compression face to centroid of boundary zone
- $Eq_{solidthickness}$ = value from RMEH textbook which represents the "average" thickness of wall considering block voids.

Note:

- If the **1.5x Shear Inc** checkbox is checked in the [Masonry Wall - Design Rules](#), then f_v is factored up by a 1.5 factor. This option is available per section 7.3.2.6.1.2.

In Plane Shear Capacity, F_v

The program calculates the capacity, F_v , from Equation 8-22:

$$F_v := (F_{vm} + F_{vs}) \cdot \gamma_g$$

where:

$$F_{vm} := \frac{1}{2} \cdot \left(\left(4 - 1.75 \cdot \left(\frac{M}{V \cdot d} \right) \right) \cdot \sqrt{f_m} \right) + 0.25 \cdot \frac{P}{A_n}$$

$$F_{vs} := 0.5 \cdot \left(\frac{A_v \cdot F_s \cdot d}{A_n \cdot s} \right)$$

$$\gamma_g = 0.75 \text{ for partially grouted walls and } 1.0 \text{ otherwise}$$

The program also checks to verify we do not exceed the **Fv max** value from Equations 8-23 and 8-24 (or interpolation between them) that is reported in the detail report.

Fvs is only required if **fv > Fvm**. If **fv < Fvm**, then the program will not add any shear reinforcement and **Fvs = 0**. If **Fvs** is required, then the program will back calculate a spacing, **s**, that will satisfy the steel shear capacity required. This shear spacing is reported in the detail report.

When shear reinforcement is required the program will also meet the $d/2$ or 48" spacing required by 8.3.5.2.1. If **Fv max** must be exceeded to pass the code check, the program will use **Fv max** as the capacity and state "Over Allowable" for the Shear Steel Spacing.

Note:

- The program does not do explicit seismic design, thus Equation 8-25 is not used.
- The M in the F_{vm} equation above is taken as the maximum moment in the region instead of the moment at the location where the shear is maximum.

Axial Design - ASD**In Plane Axial Stress, f_a**

The axial stress in a wall due to axial forces, f_a , is calculated as:

$$f_a := \frac{P}{A_n}$$

P = Total axial force in wall at the reported location

$$A_{nRMEH} := E q_{solidthickness} \cdot L_{wall}$$

$$A_{nNCMA} := A_{nNCMAperfoot} \cdot L_{wall}$$

This is applicable for all out of plane and in-plane masonry calculations. When $f_a < f_b$ then the masonry has cracked and then a cracked section analysis is performed. See the [Bending Design - ASD](#) section below for more information on this procedure.

Note:

- The program does not design masonry for net tension forces. f_a will equal 0 ksi in these cases.

In Plane Axial Capacity, F_a

The calculation of F_a is per either Equation 8-13 or 8-14, depending on the h/r ratio. These equations match Equations 8-18 and 8-19 if you assume $A_{st} = 0$. RISA conservatively uses only the masonry in calculating the compression capacity. The equations are as follows:

if $h/r \leq 99$

$$F_a := \frac{1}{4} \cdot f_m \cdot \left(1 - \left(\frac{h}{140 \cdot r} \right)^2 \right)$$

if $h/r > 99$

$$F_a := \frac{1}{4} \cdot f_m \cdot \left(\frac{70 \cdot r}{h} \right)^2$$

where:

- r is taken from the UBC-97 Table 21-H-1 (concrete masonry units) and Table 21-H-2 (clay masonry units).
- h = effective height of wall region = $K \cdot h_{\text{actual}}$

Note:

- The program does not design masonry for net tension forces. If there is net tension, F_a will still equal the compressive capacity of masonry.

Bending Design - ASD**In Plane Stresses f_b and f_s**

These calculations are different depending on a cracked section or uncracked section. The wall is considered uncracked if f_a (compression) $> f_b$. The wall is considered cracked if f_a (compression) $< f_b$.

For uncracked masonry, the calculations are as follows:

$$f_b := \frac{M}{S_x}$$

where:

$$S_{xRMEH} := \frac{E q_{\text{solidthickness}} \cdot d^2}{6} \quad S_{xNCMA} := \frac{A_{nv} \cdot L_{\text{wall}} \cdot d}{6}$$

$$f_s := 0$$

where:

- d = Total length of wall

Because the masonry is uncracked, no stress can develop in the steel.

For **cracked masonry**, the program performs an iterative analysis to determine the section properties of the cracked wall.

The maximum masonry stress (f_m) is obtained by solving the moment equilibrium equation as a quadratic equation of kd . This equation comes from vertical equilibrium ($C - P - T = 0$).

Here is a representative wall with axial force and moment:

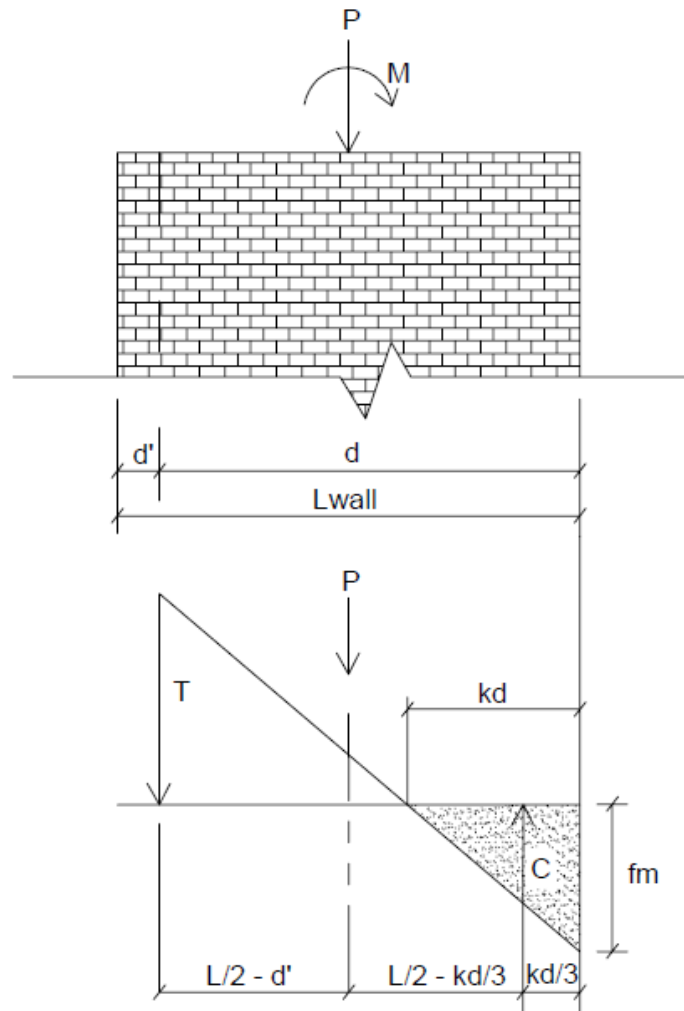

From this image we do a summation of moments about point T and come up with a quadratic equation in terms of kd .

$$\text{Quadratic} := \frac{t \cdot f_m}{6} \cdot (k \cdot d)^2 - \frac{t \cdot f_m}{2} \cdot (L - d_{prime}) \cdot k \cdot d + P \cdot \left(\frac{L}{2} - d_{prime} \right) + M$$

An assumption is made for $f_m = f_a + f_b$, where $f_a = P/A$ and $f_b = M/S$. From this C and T is determined. Once we calculate a value for T we can then define the boundary zone steel required. The final solution is determined through iteration. Each iteration of the steel area is based on the amount of steel needed to create a 0.005 ksi difference in the calculated bending stress (f_b) and is carried out until the calculated value of required reinforcement is less than the reinforcement provided.

The final values are given in the detail report:

$$f_m := f_a + f_b$$

$$C := \frac{1}{2} \cdot f_m \cdot t \cdot k \cdot d$$

$$T := C - P$$

A good reference for this iterative procedure is Section 7.10.1 of **Design of Reinforced Masonry Structures**, copyright 2001 by Narendra Taly and published by McGraw-Hill.

From this analysis f_m is calculated. This must then be broken down into f_a and f_b for the detail report. Because Section 8.3.4.2.2 states:

$$f_a + f_b \leq 0.45 \cdot f_m$$

the proportion is simplified. RISA will simply take $f_a = P/A_n$ for f_a and the remaining value from f_m is used as f_b .

From the tension force in the wall, T , the program calculates the required number of boundary zone bars and places them in the wall. The reported code check is then based on:

$$f_s := \frac{T}{A_s}$$

$$Steel_{Unity} := \frac{f_s}{F_s}$$

In Plane Masonry Bending Capacity, F_b

For unreinforced masonry, the Equation 8-15 is:

$$F_b := \frac{1}{3} \cdot f_m$$

For reinforced masonry, Section 8.3.4.2.2 states:

$$f_a + f_b \leq 0.45 \cdot f_m$$

Because of this provision, RISA defines:

$$F_b := 0.45 \cdot f_m$$

In Plane Steel Capacity, F_s

Section 8.3.3.1 defines the allowable steel stress, F_s .

In Plane Design - Strength

In Plane Axial Strength, P_n

This is calculated from Equations 9-15 and 9-16:

if $h/r \leq 99$:

$$P_n := 0.8 \cdot \left(0.8 \cdot A_{n1} \cdot f_m \cdot \left(1 - \left(\frac{h}{140 \cdot r} \right)^2 \right) \right)$$

if $h/r > 99$:

$$P_n := 0.8 \cdot \left(0.8 \cdot A_n \cdot f_m \cdot \left(\frac{70 \cdot r}{h} \right)^2 \right)$$

Note:

- Keep in mind that A_n is calculated differently for NCMA vs RMEH. See the [Masonry Wall - Design Rules](#) topic for more information.
- h = effective height of wall region = $K \cdot h_{\text{actual}}$

In Plane Moment Strength, M_n

The M_n value is based on the axial - moment interaction diagram for the wall based on strain compatibility at different levels of axial force. Once the interaction diagram is created the M_u is plotted and the code check is then calculated.

Note:

- In plane moment strength is solely accounted for by boundary zone steel. We do not use every bar in the wall and calculate the steel stress per bar. The "d" used for in plane design is from the extreme compression fiber to the centroid of reinforcement in the boundary zone. For a reference on this, see "Masonry Structures Behavior and Design" by Drysdale, Hamid, and Baker, copyright 1999.

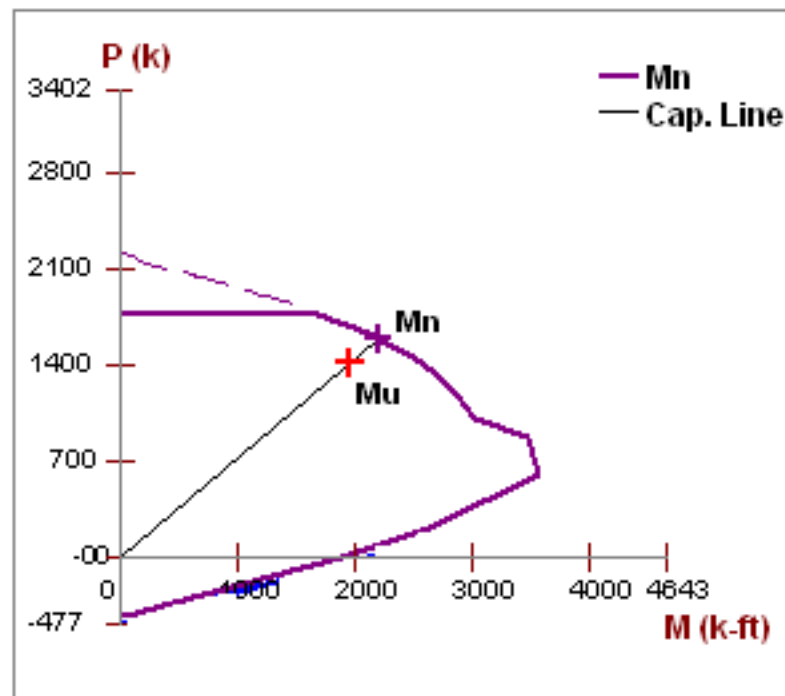

For a wall with no axial force, the M_n can be calculated from the equation:

$$M_n := A_s \cdot f_y \cdot \left(d - \frac{a}{2} \right)$$

Note:

- The maximum usable masonry strain at the extreme compression fiber, ϵ_{mu} , is assumed to be 0.0025. For assumptions of the extreme compression fiber for Seismic Detailing checks of Masonry Walls, refer to the Maximum Area of Flexural Tensile Reinforcement (Max. Flexural Rho Check - Strength) section.

In Plane Shear Strength, V_n

The program calculates the capacity, V_n , from Equation 9-17:

$$V_n := (V_{nm} + V_{ns}) \cdot \gamma_g$$

where:

$$V_{nm} := \left(4 - 1.75 \cdot \left(\frac{M_u}{V_u \cdot d} \right) \right) \cdot A_{nv} \cdot \sqrt{f_m} + 0.25 \cdot P_u$$

$$V_{ns} := 0.5 \cdot \left(\frac{A_v}{s} \right) \cdot f_y \cdot d_v$$

$$\gamma_g = 0.75 \text{ for partially grouted walls and } 1.0 \text{ otherwise}$$

The program also checks to verify the **V_n max** value from Equations 9-18 and 9-19 (or interpolation between them) that is reported in the detail report is not exceeded.

V_{ns} is only required if **$V_u > \Phi \cdot V_{nm}$** . If **$V_u < \Phi \cdot V_{nm}$** , then the program will not add any shear reinforcement and **$V_{ns} = 0$** . If **V_{ns}** is required, then the program will back calculate a spacing, **s** , that will both satisfy the steel shear capacity required and satisfy the maximum reinforcement spacing. This shear spacing is reported in the detail report.

If **V_n max** must be exceeded to pass the code check, the program will use **V_n max** as the capacity (so the wall fails in shear) and state "Over Allowable" for the Shear Steel Spacing.

Note:

- The **M** in the **V_{nm}** equation above is taken as the maximum moment in the region instead of the moment at the location where the shear is maximum. This is generally a conservative assumption.

Unreinforced Masonry Design - ASD**In Plane Bending and Axial Design - ASD**

For unreinforced masonry we use the same design provisions from reinforced masonry. Thus, we still use reinforcement for both the boundary zones and shear reinforcement (if needed). See the reinforced sections for more information on this design.

Note:

- Because this type of design is very uncommon it is not currently available.

In Plane Shear Design - ASD

The in plane shear stress, f_v , is calculated as follows:

$$f_v := \frac{V}{A_{nv}}$$

The in-plane shear stress capacity, F_v , is calculated from Section 8.2.6.2. Because we do not know whether the wall is in running bond or not we omit options (c), (d), (e) and (f).

Unreinforced Masonry Design - Strength

In Plane Bending, Axial, and Shear Design - Strength

For unreinforced masonry we use the same design provisions from reinforced masonry. Thus, we still use reinforcement for both the boundary zones and shear reinforcement (if needed). See the reinforced sections for more information on this design.

Note:

- Because this type of design is very uncommon it is not currently available.

Masonry Lintel Design - ASD

Here we will talk about specific calculations regarding lintel design for allowable stress design.

Note:

- There is no lintel design for unreinforced lintels. Regardless of whether you design the wall as reinforced or unreinforced, all lintel design will use reinforcement. Because unreinforced lintels are very uncommon it is not currently available.

Shear Stress, f_v

This stress is calculated from Equation 8-21:

$$f_v := \frac{V}{b \cdot d}$$

where:

- d = distance from extreme compression fiber in top of lintel to the centroid of reinforcement.

Shear Capacity, F_v

The program calculates the capacity, F_v , from Equation 8-25, which is shown in the previous [In Plane Shear Capacity \$F_v\$](#) section.

The program also checks to verify we do not exceed the **F_v max** value from Equations 8-23 and 8-24 (or interpolation between them) that is reported in the detail report.

F_v s is only required if $f_v > F_{vm}$. If $f_v < F_{vm}$, then the program will not add any shear reinforcement and **F_v s = 0**. If **F_v s** is required, then the program will back calculate a spacing, **s** , that will satisfy the steel shear capacity required. This shear spacing is reported in the detail report.

When shear reinforcement is required the program will also meet the $d/2$ or 48" spacing required by 8.3.5.2.1. If **Fv max** must be exceeded to pass the code check, the program will use **Fv max** as the capacity and state "Over Allowable" for the Shear Steel Spacing.

Note:

- The program does not do explicit seismic design, thus Equation 8-25 is not used.
- The M in the F_{vm} equation above is taken as the maximum moment in the region instead of the moment at the location where the shear is maximum. This is generally a conservative assumption.
- The detail report shows a stirrup with two legs. However, the program only considers one leg in the A_v calculation.

Bond Stress, u , and Bond Capacity U

The bond stress check is one that has been grandfathered in from the UBC-1997 specification section 2107.2.16 and is defined previously in the [In Plane Bond Stress \$u\$](#) section. Σo is the summation of the circumference of all vertical bars.

The bond stress capacity was defined previously in the [Bond Stress Capacity \$U\$](#) section.

Stresses f_b and f_s

The masonry bending stresses were defined previously in the [Out of Plane Stresses \$f_b\$ and \$f_s\$](#) section.

Bending Capacity, F_m (F_b) and Steel Capacity, F_s

Section 8.3.4.2.2 states:

$$F_b := 0.45 \cdot f_m$$

Section 8.3.3.1 defines the allowable steel stress, F_s .

Masonry Lintel Design - Strength

Here we will talk about specific calculations regarding lintel design for strength design.

Note:

- There is no lintel design for unreinforced lintels. Regardless of whether you design the wall as reinforced or unreinforced, all lintel design will use reinforcement. Because unreinforced lintels are very uncommon it is not currently available.

Shear Strength, V_n

The program calculates the capacity, **Vn, total** from Equation 9-17, which was shown previously in the [In Plane Shear Strength \$V_n\$](#) section.

The program also checks to verify the **Vn max** value from Equations 9-18 and 9-19 (or interpolation between them) that is reported in the detail report is not exceeded.

Vn,steel is only required if $V_u > \Phi \cdot V_{n,masonry}$. If $V_u < \Phi \cdot V_{n,masonry}$, then the program will not add any shear reinforcement and **Vn,steel** = 0. If **Vn,steel** is required, then the program will back calculate a spacing, **s**, that will satisfy the steel shear capacity required. This shear spacing is reported in the detail report.

If **Vn max** must be exceeded to pass the code check, the program will use **Vn max** as the capacity (so the wall fails in shear) and state "Over Allowable" for the Shear Steel Spacing.

Note:

- The M in the V_{nm} equation above is taken as the maximum moment in the region instead of the moment at the location where the shear is maximum. This is generally a conservative assumption.

Moment Strength, M_n

Lintel design in RISA does not account for axial force, thus M_n is calculated simply from:

$$M_n := A_s \cdot f_y \cdot \left(d - \frac{a}{2} \right)$$

Here are the calculations of other values reported in the detail report:

$a := \frac{A_s \cdot f_y}{0.8 \cdot f_m \cdot b}$	Depth of compression block
$c := \frac{a}{0.8}$	Neutral Axis Location
$C := a \cdot b \cdot 0.8 \cdot f_m$	Total compression in the compression block
$M_{nmasonry} := C \cdot \left(c - \frac{a}{2} \right)$	Moment capacity from NA to compression block
$M_{nsteel} := A_s \cdot f_y \cdot (d - c)$	Moment capacity from NA to tension steel

Masonry Wall - Design Rules

The masonry wall panel element allows you to easily model, analyze and design masonry walls for in plane loads. In this section, we will explain the masonry specific inputs and design considerations. For general wall panel information, see the [Wall Panels](#) topic. For masonry wall modeling procedures, see the [Masonry Wall - Modeling](#) topic. For masonry calculation considerations and code references, see the [Masonry Wall - Design](#) topic. For masonry wall results interpretation, see the [Masonry Wall Results](#) topic.

Note:

- All code references in this topic refer to the **TMS 402-16** specification unless noted otherwise.

Unity Check

Setting a maximum Bending Check (Axial & Bending) or a maximum Shear Check controls the rebar which the program chooses for the wall design. A value of 1.0 denotes that the program may choose a rebar layout that is at 100% of capacity.

Note:

- For the **Max Shear Check** for in plane design, the program will only optimize the spacing of reinforcement. It will not optimize the grout spacing. If you want to adjust grout spacing, review the **Masonry Out** tab.

Masonry Wall General

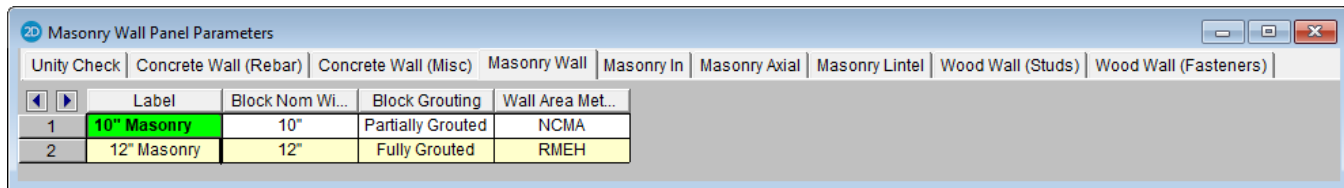

	Label	Block Nom Wi...	Block Grouting	Wall Area Met...
1	10" Masonry	10"	Partially Grouted	NCMA
2	12" Masonry	12"	Fully Grouted	RMEH

Block Nominal Width

This is the nominal thickness of masonry walls. The program will subtract 3/8" from this value to get the actual thickness. This value is used, along with the value of grout / bar spacing, to determine the effective thickness of the wall. The effective thickness is based on table B3 of the Reinforced Masonry Engineering Handbook, by Amrhein, Copyright 1998.

Block Grouting

This option defines how the wall is grouted. If "Partially Grouted" is chosen, then the spacing of grout will be based on the bar spacing defined on the **Masonry Out** tab.

Wall Area Method

This option defines where the wall area is taken from. The **NCMA** option pulls the " A_n " value from the NCMA TEK 141B document. The **RMEH** option pulls the "Equivalent Solid Thickness" value from Table B-3a and B-3b from the *Reinforced Masonry Engineering Handbook*, James Amrhein, 5th edition copyright 1998.

In doing research on these two methods of calculating the area for a masonry wall, the two methods produce very different results. The **NCMA** values assume face-shell mortar bedding and web bedding around grout-filled cells. The **RMEH** values assume full mortar bedding (both face-shells and all webs). The Amrhein values also appear to average in the area of horizontal bond beams as well. This would make the area conservative for a

self-weight calculation, but unconservative for stress calculations. With these considerations in mind we are defaulting the behavior to use **NCMA** by default.

See the [Masonry Wall - Design](#) topic for the specific calculations regarding NCMA or RMEH.

Note:

- In version RISA-2D V11 and older the program used both methods in different circumstances. Now the program is consistent with this usage.
- If you open an existing model from RISA-2D V11 and older the program will default to the **RMEH** option.
- If you start a model from scratch the program will default to the **NCMA** option.
- For self-weight the program will ALWAYS use **RMEH**, as the presence of bond beams in the wall is realistic and this is a conservative value.

Masonry Wall In Plane Design

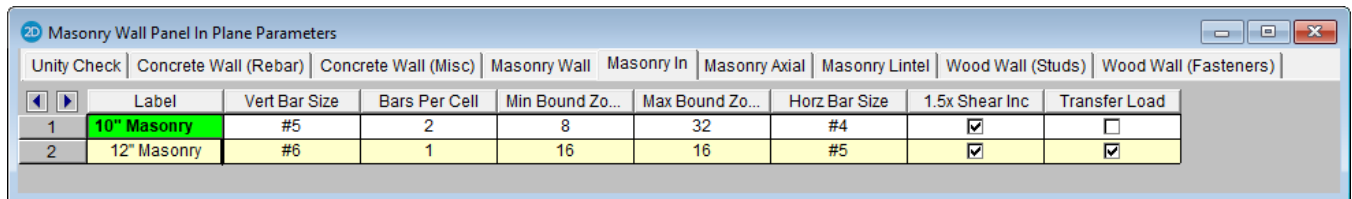

	Label	Vert Bar Size	Bars Per Cell	Min Bound Zo...	Max Bound Zo...	Horz Bar Size	1.5x Shear Inc	Transfer Load
1	10" Masonry	#5	2	8	32	#4	<input checked="" type="checkbox"/>	<input type="checkbox"/>
2	12" Masonry	#6	1	16	16	#5	<input checked="" type="checkbox"/>	<input checked="" type="checkbox"/>

Vert Bar Size

Allows you to define vertical bar size for the boundary zones.

Bars Per Cell

Allows you to define one or two bars per cell in the boundary zones.

Min/Max Boundary Zone

Allows you to give a maximum and minimum boundary zone width. The program will then design the width based on 8" increments (1/2 of a block length).

Horz Bar Size

Allows you to define horizontal bar size to be used if horizontal reinforcing is required.

1.5x Shear Inc

The 1.5x Shear Inc checkbox has been moved to the Seismic Design Rules spreadsheet in the Masonry Walls tab. Please see Masonry Wall - Seismic Design.

Transfer Load

This option will transfer in plane loads from regions above and below openings into the regions adjacent to the openings. Note that the design of regions above and below openings will be omitted.

Masonry Wall Axial Design

	Label	Bar Space Min	Bar Space Max	Mortar Type	Cement Type
1	Typical	8"	72"	Type M or S	Portland, Lime/Mortar
2	10" Masonry	8"	72"	Type M or S	Portland, Lime/Mortar
3	12" Masonry	8"	72"	Type M or S	Portland, Lime/Mortar
4	Lightweight	32"	32"	Type N	Masonry, Air Entrained PCL

Bar Space Min/Max

This allows you to give a maximum and minimum bar/grout spacing. If you give a range between the max and min, then the program will optimize the reinforcement spacing according to strength requirements (code checks).

Mortar/Cement Types

Allows you to specify the type of mortar/cement in the wall. This affects the modulus of rupture (flexural tensile stresses) from Tables 8.2.4.2 and 9.1.9.2.

Masonry Wall Lintel Design

	Label	Depth[i...]	Bear Leng...	Bar Size	Min # Bars...	Max # Bar...	Num of La...	c/c Sp of L...	Dist to Botf...	Stirrup Size	Analysis Method
1	10" Masonry	16	8	#6	3	5	2	8	3.5	#3	Simply Supported
2	12" Masonry	16	8	#6	3	5	1	N/A	3.5	#4	FEA

Depth

This is the total depth of your lintel.

Bear Length

This is the bearing length at either end of the lintel. This is used to calculate the effective length of the lintel.

Bar Size

This is the reinforcement size for your main reinforcing in the lintel.

Min/Max # Bars Per Layer

This is the number of bars you wish to have in a given layer of reinforcement. If you give a range between the max and min, then the program will optimize the reinforcement spacing based on geometry of the section and also the number of layers that you have defined.

Num of Layers

This is an option if you require multiple layers of reinforcement in the lintel.

c/c Sp of Layers

This is the distance between layers (if there is more than one).

Dist to Bot

This defines the distance from the centerline of the lowest-most bar to the bottom fiber of the lintel.

Stirrup Size

This is the size of stirrup that will be added to the lintel if required.

Analysis Method

This is the lintel analysis method that will determine the design of the masonry lintel. The Simply Supported analysis method will produce lintel reinforcement design results, which can be seen in the [masonry lintel detail report](#). The FEA analysis method will only display shear and moment diagrams in the detail report for the masonry lintel based on the results of finite element analysis.

Masonry Wall Results

Masonry wall results are presented in the wall results spreadsheets and the detail reports. Results are reported on a region by region basis. In addition, the code checks for lintels spanning openings are reported separately.

For general wall panel information, see the [Wall Panels](#) topic. For information on masonry design rules, see the [Masonry Wall - Design Rules](#). For masonry wall modeling procedures, see the [Masonry Wall - Modeling](#) topic. For masonry calculation considerations and code references, see the [Masonry Wall - Design](#) topic.

Note:

- All code references in this topic refer to the **TMS 402-16** specification unless noted otherwise.

Masonry Wall Spreadsheet Results

The information on this spreadsheet is present on two tabs that involve Masonry design: In plane, and Lintel. Each tab gives code checks based on the chosen masonry code and can be used as a summary of all of the panels and panel regions in your model. To get detailed information about each region, you can see the Wall Panel Detail Report.

In Plane

		Concrete In	Masonry In	Masonry Lintel	Wood Wall Axial	Wood Wall In-Plane				
Wall Panel	Region	Combined UC	LC	Shear UC	LC	Fa[ksi]	Fb[ksi]	Fv[ksi]		
1	WP3	R1	.9333	1	1.9596	1	.3592	.5	.0749	
2	WP4	R1	1.5556	1	1.1702	1	.3399	.5	.0581	

The **In-Plane** results are intended to provide the code checks relevant to shear wall behavior for the wall.

For ASD codes the **Combined UC** entry gives the code check due to axial force plus in-plane bending. The **Shear UC** will show the code check for shear effects. A value greater 1.0 for either of these values would indicate failure.

For Strength codes the **Axial UC**, **Bending UC** and **Shear UC** gives the individual code checks for each of these limit states.

The **Fa** or **Pn*Phi** reports the allowable axial stress or axial capacity.

The **Fb** or **Mn*Phi** reports the calculated allowable bending or moment capacity for the region.

The **Fv** or **Vn*Phi** reports the calculated allowable shear stress or Shear Capacity for the region.

Lintels

		Concrete In	Masonry In	Masonry Lintel	Wood Wall Axial	Wood Wall In-Plane				
Wall Panel	Lintel	Flexure UC	LC	Shear UC	LC	Fvm[ksi]	Fvs[ksi]	Fm[ksi]	Fs[ksi]	
1	WP3	L1	.876	1	2.066	1	.0387	.1162	.5	24
2	WP4	L1	1	1	3.286	1	.0387	.1162	.5	24

The Lintel results give the results for the masonry lintels that span over user defined openings in the wall. They can also be viewed by looking at the detail report associated with each opening.

The **Bending UC** entry gives the code check due pure flexure of the Lintel. Axial force is not considered in this code check at all. The **Shear UC** gives the code check for shear. A value greater 1.0 for either of these values would indicate failure.

The **Fm** and **Fs** or **Mn*Phi** reports the calculated allowable bending stress or moment capacity for the region.

The **Fvm** and **Fvs** or **Vn*Phi** reports the allowable shear stress or shear capacity.

Concrete Reinforcing Spreadsheet Results

The last two tabs of this spreadsheet contain results for Masonry Wall reinforcement.

Masonry Wall

	Wall	Region	Hor. Bar Size	Boundary Reinf.
1	WP2	R1	Over Allowable	1-#6
2		R2	Not Req.	1-#6
3	WP3	R1	Not Req.	1-#6
4		R2	Not Req.	1-#6

The Masonry Wall tab displays analysis results for the reinforcement of each region defined in your masonry wall.

Lintel Reinforcing

	Wall	Lintel	Flex. Steel	Stirrup
1	WP2	L1	1-#6	Not Req.

The Lintel Reinforcing tab displays analysis results for the reinforcement of each lintel defined in your masonry wall.



Masonry Wall Detail Reports

The detail reports show the overall geometry, analysis and design for the individual regions of the wall panel. The report also shows envelope diagrams for the forces and moments in the region.

Three basic types of detail reports are provided: Wall Summary, Region and Opening.

Accessing the Detail Reports and the Specific Windows

Once you have a solved model, the detail reports become available. They are accessible in two ways:

1. If you have the **Wall Panel Design** spreadsheet open, there will be a button at the top of the screen:  you can right click and select **Detail Report**. This will open up the detail report window.
2. If you are in a graphic view of your model, there is a  button on the Selection toolbar. Clicking this button and clicking on a wall panel will open up the detail report window for that wall panel.



Note:

- If a wall panel is set to Transfer forces, then regions above and below opening will not have results. See the [Concrete Wall - Design Rules](#) topic for more information.

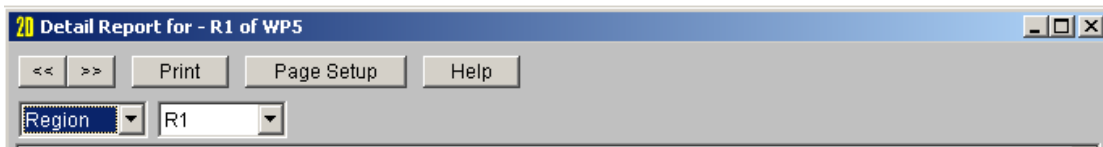
Once the detail report window is open, you will see a dialog area at the top.



These options control the display of the Detail Report:

-   - The arrow buttons allow you to scroll quickly between the different wall panels in your model.
-  - This button will allow you to take a snapshot of the current detail report you are viewing so that it can be added to a report. View the [Printing](#) topic for more information.

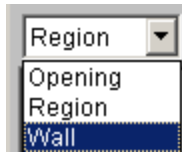

- - The first drop down list allows you to select between individual Region and Opening (Lintel) results and a summary of the entire Wall. Below we will explain the importance of each of these sections.
- - The second drop down list allows you to select between different Regions or Openings within the individual wall panel.

Wall Report

This report gives an overview of the wall, a summary of the controlling code checks and deflection information. This report also displays information about the wall, similar to the [Region Input Echo](#) and also gives an image of the wall. The image shows region locations, wall length and story dimensions, and the nodes that define the corners of the wall panel.

CRITERIA	MATERIALS	GEOMETRY
Code : ACI 530-13: ASD	Masonry fm : 1.5 ksi	Total Height : 16 ft
Special Insp : Yes	Masonry Em : 1350 ksi	Total Length : 10 ft
Design Rule : Typical	Steel fy : 60 ksi	Blk Nom Width : 10"
Wall Area : NCMA	Steel E : 29000 ksi	Blk Grouting : Partially Grouted
Transfer In? : No	Blk Material : Conc 115 pcf	1.5 Shear Factor: Yes
Transfer Out? : No	Grt Weight : 140 pcf	Parapet Height : 4 ft
K : 1	Mortar Type : Type M or S	
Use Cracked? : Yes	Cement Type : Portland, Lime/Mortar	
In lcr Factor : .5		
Out lcr Factor : .5		
Custom Regions: No		

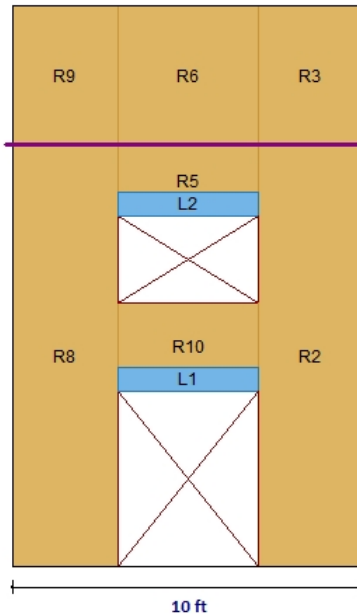

REGION RESULTS

Region	UC Max		UC Shear		Delta Max	
	In Plane	LC	In Plane	LC	In Plane(in)	LC
R1	.077	15	.075	15	.018	15
R2	.048	15	.258	15	.003	15
R3	.1	15	.183	15	0	15
R4	.161	15	.085	15	.018	15

REINFORCEMENT RESULTS

Region	Vertical Reinforcement	Horizontal Reinforcement
R1	#6@18in oc e.f.	#4@12in oc e.f.
R2	#6@13in oc e.f.	#4@12in oc e.f.
R3	#6@13in oc e.f.	#4@12in oc e.f.
R4	#6@18in oc e.f.	#4@12in oc e.f.

The **Region Results** section gives the tabulated results of all regions in the wall for in plane design axial/bending, shear and deflection for quick reference. You can view the individual region reports to get a more detailed explanation of these values.

The **Reinforcement Results** section gives the reinforcement results for each region in the wall.

The **Lintel Reinforcement Results** section gives the label and reinforcement for any lintels in the wall.

In Plane Masonry Detail Reports

You can click any of the **In-Plane** region sections in order to expand the section and view additional details pertinent for that specific region.

In Plane-Masonry - Input Echo

The top section of the detail report echoes back the input information used in the design of the wall region or lintel. This information is summarized below:

CRITERIA		MATERIALS		GEOMETRY			
Code	: ACI 530-11: ASD	Masonry fm	: 1.5	ksi	Total Height	: 10	ft
Special Insp	: Yes	Masonry Em	: 1350	ksi	Total Length	: 12	ft
Wall Area	: NCMA						
		Steel fy	: 60	ksi	Blk Grouting	: Partially Grouted	
Hor Bar Size	: #5	Steel E	: 29000	ksi	Grt/Bar Spacing	: 72"	
Vert Bar Size	: #5						
		Blk Material	: Conc 115 pcf		Blk Nom Width	: 10"	
No of Ten Bars	: 1	Grt Weight	: 140 pcf		1.5 Shear Factor:	Yes	
Effective Depth	: 140	in	Wall Dead Wt	: .056	ksf		

Criteria	Description
Code	Gives the code used to design your wall panel.
Special Inspection	Indicates whether special inspection is required for your wall. Special inspection is normally required for all walls designed to the MSJC / IBC codes. The UBC 1997 is the one code that allows the user to decide whether special inspection is required.
Wall Area	See the Wall Design Rules - Masonry Wall spreadsheet
Horizontal Bar Size	Indicates the bar size to be used to resist shear forces.
Vertical Bar Size	Indicates the bar size to be used to resist the tensile stress due to moment.
Number of Tension Bars	Indicates the number of vertical bars present in the boundary region of the wall.
Effective depth	This gives you the distance from the compression face of the wall to the centroid of tension reinforcement.

The **Materials** column can be mostly modified under the Materials button on the Data Entry toolbar.

The **Geometry** column gives the basic geometry of the wall. Block grouting and the grout spacing are specified in the Wall Panel Editor. The block nominal width is input under the [Wall Design Rules - Masonry Wall](#) tab.

In Plane Masonry - Force Diagrams and Code Check Summary

The next section of the detail report displays the envelope axial shear and moment diagrams as well as a summary of the code checks performed on the shear wall.

ENVELOPE DIAGRAMS

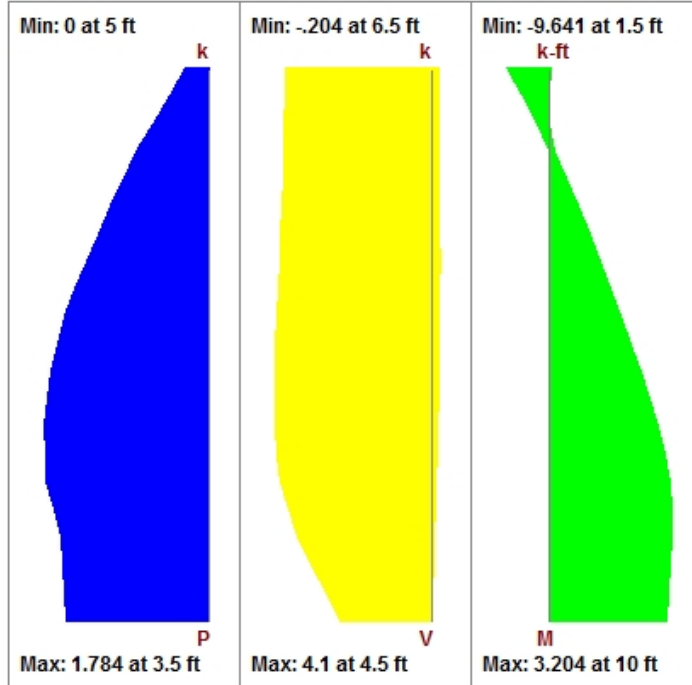

COMBINED CHECKS

(fa + fb)/Fb : .037
 fa/Fa : .01
 fs/Fs : .038

AXIAL SUMMARY

fa : .003 ksi
 Fa : .337 ksi

BENDING SUMMARY

fb : .022 ksi
 Fb : .675 ksi
 fs : 1.221 ksi
 Fs : 32 ksi

SHEAR CHECKS

fv / Fv : .167

SHEAR SUMMARY

fv : .012 ksi
 Fv : .072 ksi
 Fvm : .072 ksi
 Fv max : .116 ksi

The **Combined Check Summary** gives maximum overall code checks considering the effects of both bending and axial stresses. This section is not reported for MSJC strength design.

The **Axial Summary** and **Bending Summary** give the values used in the axial and flexural code checks at the location which controls the combined check (fa+fb)/Fb for ASD design.

For ASD design, the maximum bending stress in the flexural reinforcement is reported as **fs**, and the allowable steel bending stress as **Fs**. These values are given for the Load Combination and section that produce the maximum code check (fs/Fs).

The **Shear Summary** reports the maximum shear demand on the beam as **fv** or **Vu**. The allowable shear stresses are then reported as **Fvm** and **Fvs**, where **Fvm** is the allowable of the masonry alone and **Fvs** is the allowable considering the effects of the shear reinforcement.

In Plane Masonry - Axial Details

DESIGN DETAILS

AXIAL DETAILS

Max Axial : 27.923 k
 Location : 0 ft
 Load Comb : 1

Rad gyration r : 3.34 in
 h/r : 35.928
 Red Factor R : .934

Axial Details	Description
Maximum Axial Force	The maximum axial force in the wall.
Location	The location along the height of the wall which produces the maximum axial force.
Load Combination	The load combination that produced the maximum axial force.
Radius of Gyration (r)	The out of plane radius of gyration for the wall.
h/r	Slenderness ratio of the wall
Reduction Factor R	This is the slenderness reduction portion of equations 8-13, 8-14, 9-11 and 9-12.

In Plane Masonry - Bending Details

Click the **Bending Design** section to expand the section and see more details.

BENDING DETAILS			BENDING DETAILS		
Max Moment	: 0	k-ft	Max Moment	: 99.99	k-ft
Location	: 0	ft	Location	: 0	ft
Load Comb	: N/A		Load Comb	: 1	
a	: 0	in	Sect Mod S	: 15237.2888	
c	: 0	in	Tension St Asv	: .442	in ²
d	: 0	in	Per of steel p	: .000657796	
			k*d	: 75.39	in
			j	: .8	

Ultimate Strength Design Working Stress Design (ASD)

Limit State	Gov. LC	Required	Available	Unity Check	Result
Axial Design	1	0.009	0.35	0.016	PASS
Bending Design	1	0	32	0.008	PASS
M = 0.672 k-ft			Max moment		
Location = 0 ft			Governing bending location		
S = 3809.322 in			Section modulus		
Asv = 0.307 in			Tension steel		
p = 0.0009431			Percentage of steel		
k*d = 11.287 ft			Length of compression block		
j = 1			Ration of distance between centroid of compressive and tensile forces		
fb = 0.002 ksi			Max bending stress		
Fb = 0.675 ksi			Allowable bending stress		
fs = 0 ksi			Max steel bending stress		
Fs = 32 ksi			Allowable steel bending stress		

Bending Details	Description
Maximum Moment	The maximum moment in the wall.
Location	The height of the wall where the maximum bending moment is located.
Load Combination	The load combination that produced the maximum bending moment.
Section Modulus (S)	The uncracked section modulus. This is based on the effective thickness and the length of the wall.
Tension Steel Asv	The area of tension steel in this region of the wall panel.
Percentage of Steel (p)	The reinforcement ratio in this region of the wall panel.
k*d	The length of the compression block.
j	The ratio of the distance between the centroid of the compressive and tensile forces (j).
a	Depth of compression block.
c	Depth of Neutral Axis.
d	Depth of section from compression fiber to centroid of tensile reinforcement.

In Plane Masonry - Cracked Section Details

CRACKED SECT ANALYSIS
 $f_m = f_a + f_b$: **.144 ksi**
 C : **28.493 k**
 T : **.57 k**

See the [Masonry Wall - Design](#) topic for more information.

In Plane Masonry - Shear Details

SHEAR DETAILS
 Max Shear : **.085 k**
 Location : **0 ft**
 Load Comb : **1**

Corresponding M : **.2473 k-ft**
 $M / (V*d)$: **1.0916**
 Shear St Area : **Not Reqd.**
 Shear Spacing : **N/A**
 Peri of bars : **N/A**

Shear Details	Description
Moment	The moment corresponding to the maximum shear check is reported along with the M/Vd ratio.
Shear Steel Area	<p>The shear area per bar (A_v) is reported along with its center to center spacing and the perimeter of the reinforcing bars used for the calculation of allowable bond stress.</p> <ul style="list-style-type: none"> • If the shear can be taken by the masonry block alone, we will report "Not Reqd." • If shear reinforcement is required, we will report "Yes." • If the wall maximum shear the wall can take is reached, we will report "Over allowable."
Shear Bar Spacing	The spacing of shear steel in the region of the wall panel.

In Plane Masonry - Cross Section Detailing

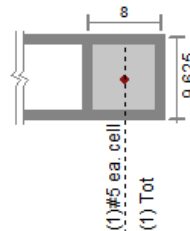

No horizontal reinforcement required

NOTE: All units are in "in."

Cross Section Detailing

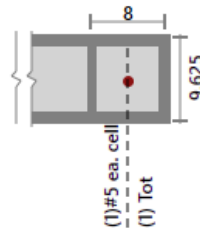

No horizontal reinforcement required

NOTE: All units are in "in"

This section of the detail report is meant to provide a visual confirmation to the user of the boundary zone width and reinforcement.

BENDING DETAILS

Mu / phi*Mn	:	Over-reinforced	
Mu, max	:	-3.47	k-ft/ft
phi Mn	:	9.66	k-ft/ft
phi	:	.9	
Location	:	0.00	ft
Load Comb	:	1	

Sectional Properties (Strength)

SECTIONAL PROPERTIES

ALL RESULTS PER C/C OF REINFORCEMENT

Total Width	:	40	in	Agross	:	167.7	in ²	As	:	.307	in ²
Eff Width	:	40	in	Igross	:	2283	in ⁴	Ase	:	.307	in ²
Flange thick tf	:	1.375	in	fr	:	0.083	ksi	Rho Provided (%)	:	.002	
Effective Thick te	:	4.192	in	Crack Mom, Mcr	:	3.041	k-ft	Rho Maximum (%)	:	.005	
				c	:	0.543	in				
				n	:	21.48					
				Icracked	:	136.6	in ⁴				

The center to center distance between reinforcing **Total Width** and the **Eff Width** (which accounts for partially grouted walls) are both reported in this section. The **Flange Thick tf** refers to the thickness of the face shell whereas the **Effective Thick te** refers to the overall effective depth of the block.

The gross area and moment of inertia are reported along with the modulus of rupture, cracking moment, neutral axis, modular ratio between steel and masonry, and the cracked moment of inertia.

The area of steel **As** and the effective area of steel **Ase** are reported, with the effective area based upon $As + Pu/fy$.

The gross steel ratio (rho gross) is calculated as the area of steel divided by the total area of the section.

The **Rho Provided (%)** is calculated as the area of steel divided by the total width times the effective depth (As/bd). This is limited to a **Rho Maximum (%)** value of $0.5 * \rho$ balanced per the UBC-97 Section 2108.2.3.7. This provision was implemented in future codes as well.

The Sectional Properties gives a number of the properties used during the iterative slender wall design procedure. All of these properties are reported based on a section of wall equal to the center to center spacing of the reinforcement.

Masonry Detail Reports - Lintels

Lintels - Criteria / Materials / Geometry

The first section of the detail report echoes back the basic input parameters (Criteria, Materials, Geometry) entered by the user. An example is shown below:

CRITERIA		MATERIALS		GEOMETRY			
Code	: ACI 530-11: ASD	Masonry fm	: 1.5	ksi	Dist to Top of Wall : 3.167	ft	
Special Insp	: Yes	Masonry Em	: 1350	ksi			
Type of Design	: ASD	Steel fy	: 60	ksi	Actual Length	: 5	ft
		Steel E	: 29000	ksi	Bearing Length	: 8	in
					Eff Length	: 5.667	ft
Stirrup Size	: #4	Beam Dead Wt	: .131	k/ft	Eff Width	: 9.625	in
Flex Steel	: 1-#5	Wall Dead Wt	: .098	ksf			
					Eff depth	: 12.5	in
					Total Depth	: 16	in

The geometry portion and the dead weight of the wall warrant further explanation

Attribute	Description
Beam Dead Weight	This is based on the user defined density for the Lintel / Opening.
Wall Dead Weight	This is based on the wall self weight or the self weight of the region immediately above the opening.
Dist to Top of Wall	This is the distance from the top of the lintel to the top of the wall and is used in the calculation of the arching action of the lintel loads.
Actual Length	This is the total width of the opening.
Bearing Length	This is the bearing length of the lintel on either side of the opening.
Effective Length	The Center to Center distance between lintel supports. Assumed to be length of the opening plus half of the bearing area on each side.
Effective Width	The thickness of the block used to define the lintel.
Effective depth	Equivalent to the "d" distance, the distance from the effective compression face to the centerline of the tension reinforcing.
Total Depth	This is the total depth of the fully grouted portion of the lintel.

Lintel Detail Reports - Diagrams and Code Check Summary

The next section of the detail report provides the envelope shear and moment diagrams as well as a summary of the code checks for the Lintel.

ENVELOPE DIAGRAMS

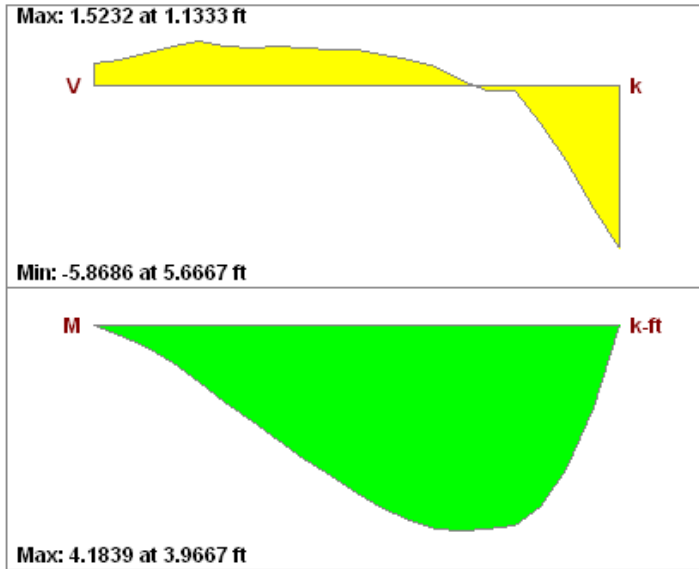

SHEAR SUMMARY

Vu/(Vn*phi)	: .46
Vu	: 5.869 k
Vn,total	: 15.956 k
Vn,masonry	: 15.956 k
Vn,steel	: 0 k
phi	: .8

BENDING SUMMARY

Mu/(Mn*phi)	: .185
Mu	: 4.184 k-ft
Mn	: 25.077 k-ft
Mn,masonry	: 3.802 k-ft
Mn,steel	: 21.275 k-ft
phi	: .9

Lintel Detail Reports - Design Details

The next section of the detail report gives further details for the design checks performed on the lintel.

DESIGN DETAILS

BENDING DETAILS

Max Moment	: 3.945 k-ft	Steel Area As	: .307 in ²
Location	: 2.3 ft	Per of steel p	: .003
Load Comb	: 1		

COMPRESSIVE STRESS BLOCK DETAILS

Depth of Block	: 1.594 in	beta 1	: .8
N.A. Location	: 1.992 in	alpha	: .8

SHEAR DETAILS

Max Shear	: 5.583 k
Location	: 3.833 ft
Load Comb	: 1
Corresponding M	: 0 k-ft
M / (V*d)	: .53
Tie Spacing	: Ties Not Reqd

Mm	: 9.1057 k-ft	k	: .3261
Ms	: 9.8442 k-ft	j	: .8913

Code Check:

Limit State	Gov. LC	Required	Available	Unity Check	Result
Bending Design	1	17.165 k-ft	215.428 k-ft	0.089	PASS
M = 1.43 k-ft Location = 3.333 ft Mu = 1.43 k-ft Mn = 17.952 k-ft Mn masonry = 1.834 k-ft Mn steel = 16.119 k-ft phi = 0.9 Max moment Governing location					
Shear Design	1	0.973 k	18.639 k	0.065	PASS
V = 0.973 k Location = 6.667 ft Vu = 0.973 k Vn, total = 18.639 k Vn, masonry = 18.639 k Vn, steel = 0 k phi = 0.8 Max shear force Governing location					
Compressive Stress Block details					
Depth of block = 1.594 in N.A. Location = 1.992 in beta 1 = 0.8 alpha = 0.8					

This **Bending Details** show the magnitude, location and load combination that correspond to the maximum moment used in the design as well as the area of flexural steel required (A_s) and the steel ratio (ρ).

The **Compressive Stress Block Details** show the parameters used in calculating the strength of the lintel.

The **Shear Details** show the magnitude, location and load combination that correspond to the maximum shear used in the design, the $M/(V*d)$ ratio for shear design, and the required spacing of ties (if applicable).

Lintel Detail Reports - Cross Section Detailing

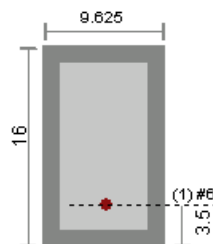

NOTE: All units are in "in."

This section of the detail report is meant to provide a visual confirmation to the user of the basic geometry and reinforcement provided in the lintel.

Wood Wall - Design

The wood wall panel element allows you to easily model, analyze and design wood walls for in-plane loads. Here we will explain the wood specific inputs and design considerations. For general wall panel information, see the [Wall Panels](#) topic. For wood wall results interpretation, see the [Wood Wall Results](#) topic.

For additional advice on this topic, please see the RISA Tips & Tricks webpage at risa.com/post/support. Type in Search keywords: **Wood Walls**.

Full code checking and design can be performed on the panel sheathing, studs, chords, headers and hold-downs based on the following codes:

- The 2015/18 edition of the NDS (Note the 2018 NDS did not include an update to the SDPWS, so it continues to use the 2015 spec for lateral wall design.)
- The 2012 edition of the NDS
- The 2005/08 edition of the NDS (National Design Specification)
- The 2014 edition of the CSA O86
- The 2009 edition of the CSA O86

Wood Wall Input

The **Wall Panel Editor** gives some specific information and options for modeling/analysis of wood walls.

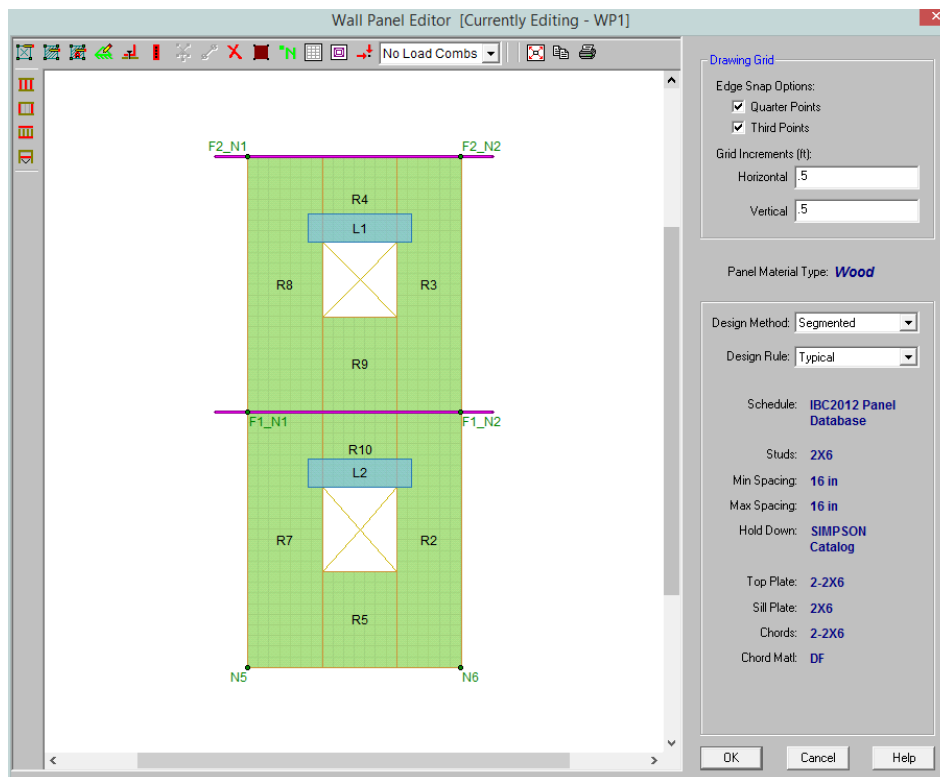

Wood View Controls



Toggle Wall Studs Display allows you to turn the display of the studs on and off.



Toggle Wall Chords Display allows you to turn the display of wall panel region chords on and off.



Toggle Top/Sill Plate Display allows you to turn the display of the top/sill plates on and off.



Toggle Opening Headers Display allows you to turn the display of headers on and off.

Design Rules

You must set up design rules for the stud/chord sizes, as well as make database selection for shear panels and hold-downs. This is done in the **Wall Design Rules** spreadsheet in the **Wood Wall (Studs)** and **Wood Wall (Fasteners)** tabs. See the [Wood Wall - Design Rules](#) topic for more information.

Creating Openings in Wood Walls with Headers

Within the **Wall Panel Editor** tab, you have the option of adding rectangular openings to wood wall panels. To draw an opening, select the **Create New Openings**  button and then select two nodes or grid intersections which make up the two diagonal corners of your opening. When an opening is drawn, a header beam is automatically created above the opening. To view or edit the properties of a header beam go to the [Wall Design Rules](#) spreadsheet. In the case where you may have different opening headers in the same wall, you can define those different headers by double-clicking inside the boundary of the drawn opening. This will bring up the **Editing Properties** window for that particular header beam.

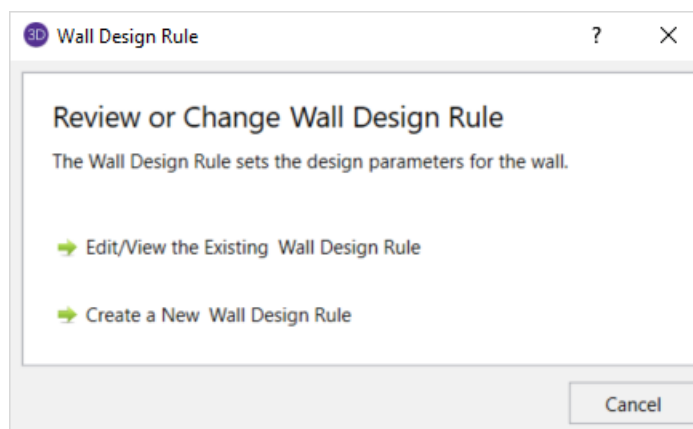
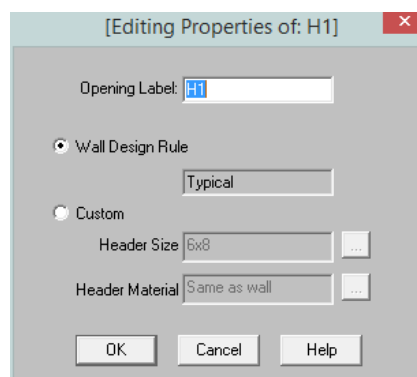

Label - This defines the name of this header and shows up in the results output for this header.

Wall Design Rule - This is the default setting here and is the default header information for all headers in the wall.

Custom - This allows you to define a header size and material that is different from the Wall Design Rule. You would only set a custom header if you have multiple headers in the same wall that are different sizes.

Hold-Downs and Straps

Hold-downs and straps are automatically added to your walls in their required locations. For a **Segmented** design, you must have hold-downs or straps at the bottom corners of each of your design segments. For

Perforated and **Force Transfer Around Openings (FTAO)**, hold-downs straps are only allowed at the two far corners of the wall panel. The program will not permit the drawing of hold-downs or straps at locations where they are not allowed.

If there are custom locations that you want to add hold-downs or straps, you can do this within the **Wall Panel Editor**.

Hold downs can represent the anchorage of your wall to the foundation or the connection of shear wall chords between floors. To add hold-downs to the base of your wall, first select the **Add New Wood Hold Downs** button



Hold downs must be added after regions are created and can only be added at the corners of regions. Hold down requirements depend on the type of wall design you are performing.

Straps represent the connection of the current wall panel to a wall panel below. To add straps to the base of

your wall, first select the Add New Wood Straps button .

Straps also can only be added after regions are created and can only added at the corners of regions. Strap requirements also follow the same logic as hold downs as to where they must be defined as far as regions are concerned.

Note:

- All boundary conditions for wall panels should be defined in the wall panel editor. Adding external boundary conditions can create problems.
- The locations of hold-downs and straps define where the program will calculate tension forces in your walls.
- If you have applied your hold-downs or straps for the Segmented design with openings in your wall, then they will be required at the interior of the wall panel. However, running Perforated or FTAO does not require hold-downs or straps at the interior of the wall panel. Thus, if you toggle between Segmented to Perforated or FTAO, then the hold-downs or straps you drew will be removed at the interior of the walls. If you switch back to Segmented, the interior hold-downs or straps will come back again.
- By default, the program will automatically add hold-downs to the base of walls that have boundary conditions applied to them and will apply straps to walls that have walls below.
- All Straps and Hold-downs are placed at the base of walls only. So, if you would like to put a strap or hold-down between floors, you would apply it to the base of the upper wall.

The output for straps and hold-downs will show up on the detail report for the wall panel. More information on this can be found in the [Wood Wall Results](#) topic.

General Requirements for Shear Walls

The design of wood shear walls per the available design codes requires that many criteria are satisfied before a wall can be considered adequate. For RISA to work within this framework, we require that certain modeling practices be followed. Outlined below are many general wall modeling practices and limitations. Also included are specific requirements for each of the three design procedures for wood wall design with openings: Segmented, Force Transfer Around Openings, and Perforated.

The three different types of shear walls are defined in Section 4.3 of the *NDS Special Design Provisions for Wind and Seismic*.

Note:

- The Canadian CSA O86 design code only supports the Segmented method, as described below.

Segmented Method

Where there is a wall panel with openings, the area above and below the openings is disregarded and the wall is designed as being made up of separate, smaller shear walls.

Like all wall panels, the segmented wood wall is broken into a series of meshed plate elements to represent the overall wall. The portions of the segmented shear wall that are considered "ineffective" in resisting shear are modeled with a plate elements that have a significantly reduced shear stiffness so that they will not receive any significant moment or shear from the FEM analysis.

See the diagram below for more information:

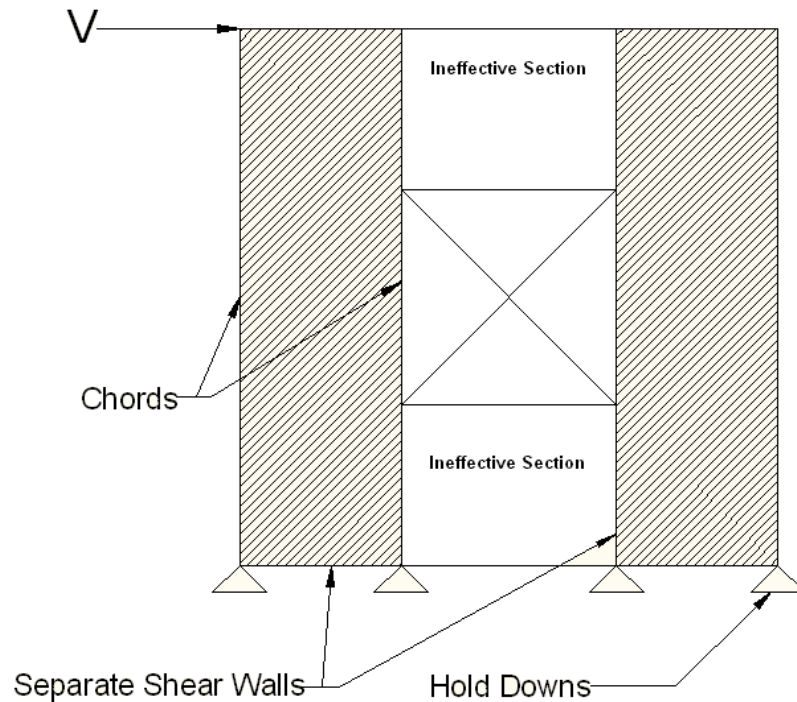

In addition, the out of plane stiffness and in plane stiffnesses of the segmented wood wall are modeled separately based on different assumed plate thicknesses. This is done to insure that the shear stiffness is based entirely on the properties of the sheathing and is not influenced by the out-of-plane stiffness of the wall studs.

Note:

- If you have several stacked Segmented wall panels with misaligned openings, you will receive the Warning Message shown below upon solution. This message means that RISA-3D has assumed that the strap force from the above wall panel will be spread out across the region directly under it. Therefore, you need to be aware of this assumption and detail the wall panel accordingly.



- A shear panel design will be chosen for the worst-case region in a segmented wall. That panel will then be used for all regions in that wall. The worst-case region is the one that has the highest Shear UC value.

Force Transfer Around Openings Method

This method is based on a rational analysis of the wall generally referred to as the "Diekmann Method" This method is documented in detail in *Design of Wood Structures ASD/LRFD (6th edition)* by Breyer, Fridley, Cobeen, and Pollock. The assumption being that straps and blocking can be added at the corners of the openings to transfer the sheathing forces across these joints. This method essentially allows you to use the entire area of the wall (minus the opening) to resist the shear in the wall.

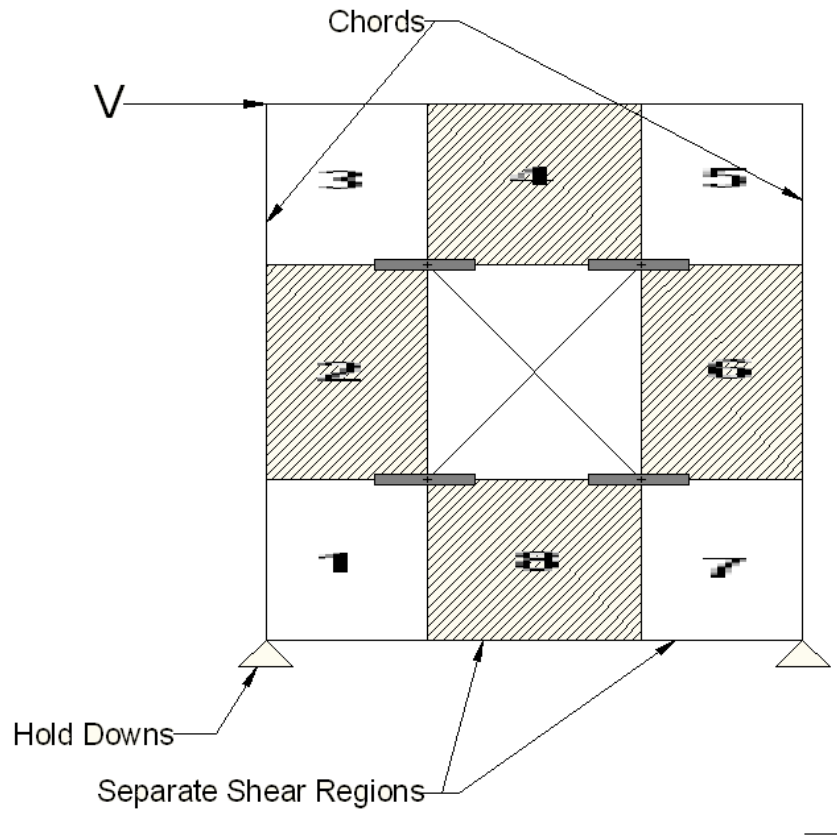

The basic assumptions made in the shear wall analysis are the following:

- The sheathing resists the shear forces. The average shear force in each block of the wall (numbered 1~8 as shown in the image above) is used as the controlling shear force in that location. The maximum shear in each of these locations will control the design of the wall. The program uses an area weighted average of the F_{xy} plate forces to determine the average shear for each block.
- The moment at the edge of each block that is above or below an opening is assumed to be transmitted across the opening interface by horizontal tension straps or compression blocks as shown in the image above. The required force is reported to the user, but the design and length of these elements is left to the engineer.
- The moment at the edge of each block that is to the right or left of an opening is assumed to be transmitted across the opening by tension straps or compression blocks. Since it is likely that the sheathing and king studs will be capable of transmitting these forces, these elements are not shown in the image above. However, these forces are reported so that the design of the studs and sheathing in these regions can be checked by the engineer to consider these effects.

Note:

- The program is limited in the automatic generation of regions for walls with multiple openings that are not aligned. Therefore, it is recommended that complex walls with multiple openings be simplified based

on engineering judgment to facilitate easier detailing of the force transfer around these openings.

- This design method is not available for Canadian CSA O86 design. If you select this design method, the program will automatically change it back to Segmented.

Perforated Method

This method for design of wood shear walls with openings may end up being the most cost effective. It only requires hold downs at the corners of the wall, yet it does not require straps or blocking around the openings. A perforated shear wall design approach is, however, subject to a number of code constraints about when it can be used.

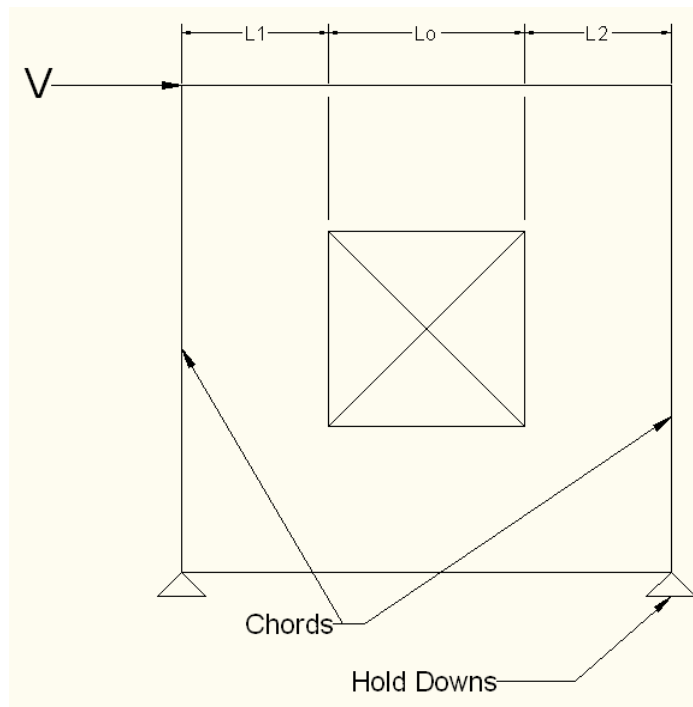

The basic design procedure for perforated walls is to essentially ignore the portions of the wall that do not have full height sheathing and treat the wall instead as a significantly shorter wall. This amplifies the chord and hold down design forces significantly while at the same time increasing the design unit shear as shown in the equations below:

$$T := \frac{V \cdot h}{C_o \cdot \Sigma L_i} \quad u_{\max} := \frac{V}{C_o \cdot \Sigma L_i}$$

Where:

$$\Sigma L_i := L1 + L2$$

Note:

- The perforated method of design also has many caveats that are given in Section 4.3.5.3 of the NDS 2015 *Special Design Provisions for Wind & Seismic*. The program will not allow the design of wall panels that do not follow these provisions.

- For multi-story perforated shear walls, the amplified hold down forces required per the code become difficult to interpret for the lower walls. Therefore, when RISA calculates the hold down forces for the lower wall it assumes that the reduction coefficients for the upper wall are identical to the values for the lower wall. This will result in conservative hold down forces when the lower wall has more openings than the upper wall. But, it may be un-conservative for situations where this is not the case. This assumption does NOT affect the shear design of either wall, nor does it affect the strap force calculations in the upper wall.
- This design method is not available for Canadian CSA O86 design. If you select this design method, the program will automatically change it back to Segmented.

Shear Capacity Adjustment Factor, Co:

The NDS *Special Design Provisions for Wind & Seismic* lists Effective Shear Capacity Ratio (Co) values that are used in calculating the nominal shear capacity of perforated shear walls. Because the tabular values are limited to wall heights of 8' & 10', RISA instead uses equation (4.3-5) from the *2015 NDS SDPWS* to calculate the Co factor for any height wall.

$$Co = \left(\frac{r}{3 - (2 * r)} \right) * \frac{L_{tot}}{\Sigma L_i}$$

Where,

$$r = \frac{1}{1 + \left(\frac{Ao}{h * \Sigma L_i} \right)}$$

When using these equations, RISA takes Ao as the true area of the openings. However, Table 4.3.3.5 of the *2015 NDS SDPWS* (Table 4.3.3.4 from older versions of the NDS SDPWS) references Co values based on all opening heights equal to the maximum opening height. Therefore if you want the program to calculate Co equal to that in Table 4.3.3.5 of the NDS, you must draw all openings as equal to the maximum height. Please see the image below for reference.

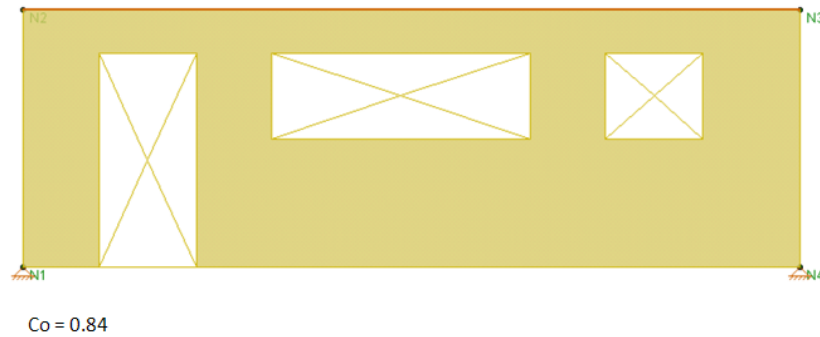

vs.

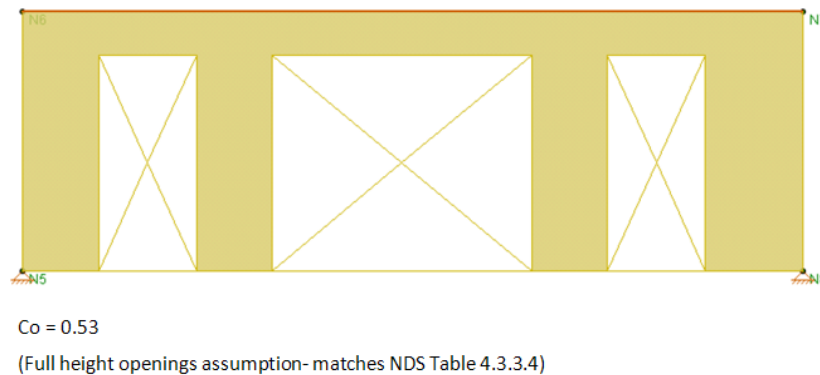
**Note:**

- When the assumption is made that all opening heights are equal to the maximum opening height then the equation produces values of C_o that are within 1% for all the values shown in the NDS table.

 C_o Limitation for Stacked Wall Panels

For wall panels that are stacked on one another, each wall panel has its own C_o value. These C_o values will be different if the openings in each wall are different. This is the source of a limitation in the program.

The program determines the design forces in each wall panel separately using the finite element solution. We then take those design forces and factor them for the C_o values. The problem is that the design forces for the bottom wall are affected by the C_o value for the upper wall. Thus, the forces that come down on a lower wall from an upper wall have been factored for the C_o from the upper wall. RISA-3D does not consider this. The program takes the forces from the finite element solution and uses the C_o value only for the wall in question.

Thus, the highest level in a stacked wall configuration will always use C_o in a correct manner. The lower wall(s), however, will be conservative if they have more openings than the upper wall(s) and can be unconservative if the upper wall(s) have more openings than the lower wall(s).

This limitation must be considered when designing Perforated walls that are stacked.

General Program Functionality and Limitations

Modeling Tips- Platform Framing

The wood wall height in RISA is measured from the bottom of the sill plate to the top of the floor framing as shown below. However, platform framing causes the wall height to be significantly shorter than a RISA model would represent.

The design method FTAO is the only method that will cause significant problems because the region above openings is assumed to be much larger than it is built. In order to adjust for this framing depth, you can adjust your opening height to include the depth of the floor framing. This will reduce the portion of the wall above the opening thus reducing the amount of area to transfer shear forces.

In Segmented and Perforated design methods, the portion above and below the opening are not used to transfer shear forces.

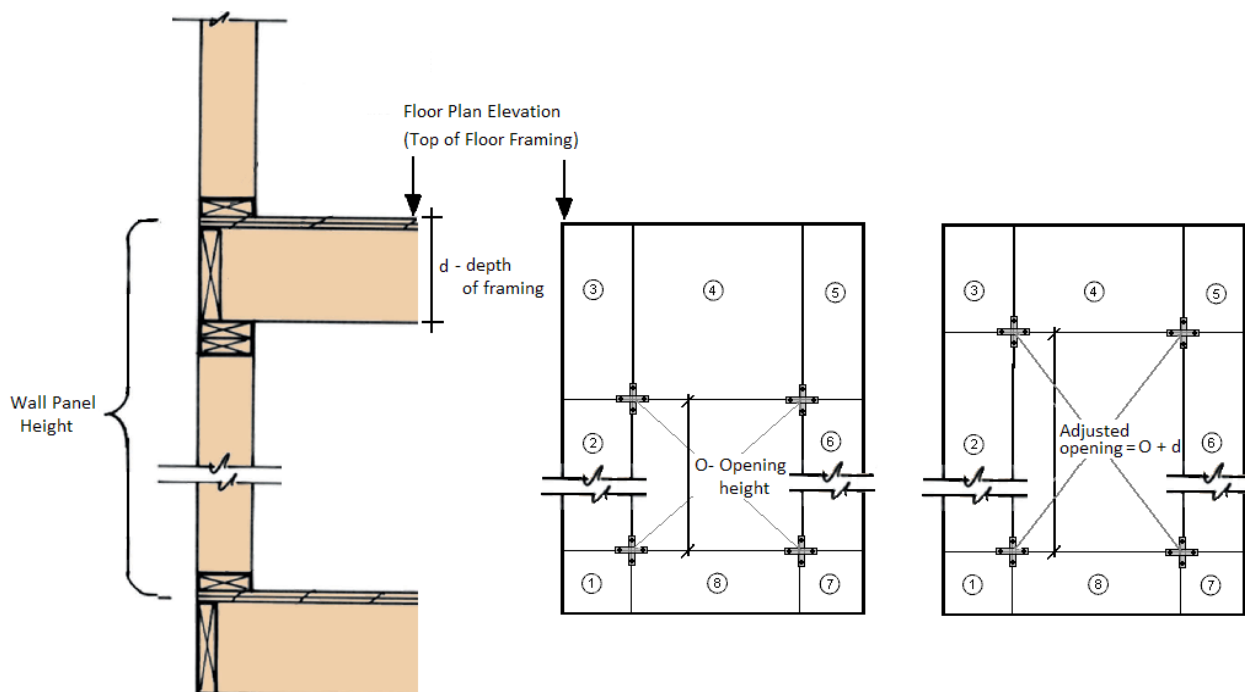

Limitations for Hold-downs / Straps (Including deformation)

- The program does not currently have a database for continuous tie rod hold-downs. However, the design results that are presented for each floor are intended to provide the type of information necessary for the design of these types of hold downs.
- The d_a values (deflection at peak load) from our hold-down database are based entirely on the manufacturers listed values. These do not include any allowance for shrinkage (which is often as much as 1/4" or more per floor), or crushing of the sill plate.
- There is not currently a d_a value used in the calculation for strap deformation for upper floor levels.

Automatic Boundary Conditions

- In RISA-2D, if no boundary conditions or hold downs are defined for wood wall panels at the lowest level of the structure, the program will automatically create hold downs at the corners of the wall panel. If you do not want the hold downs to be automatically created, define a "free" boundary condition at the base of the wall panel in the wall panel editor.

Deflection

- There is currently no code check for drift or deflection for shear wall panels.

Chord Design

The chord design is based on forces that are calculated differently for Compression versus Tension. The tension chord force is calculated including the dead load stabilizing moment as per Section 4.3.6 of the NDS 2015 *Special Design Provisions of Wind & Seismic*. The compression chord force includes the only the tributary area of one stud spacing in the compression force. For Segmented design, the chord forces are found based on each region, and in FTAO and Perforated design methods the chord forces are determined for the entire wall.

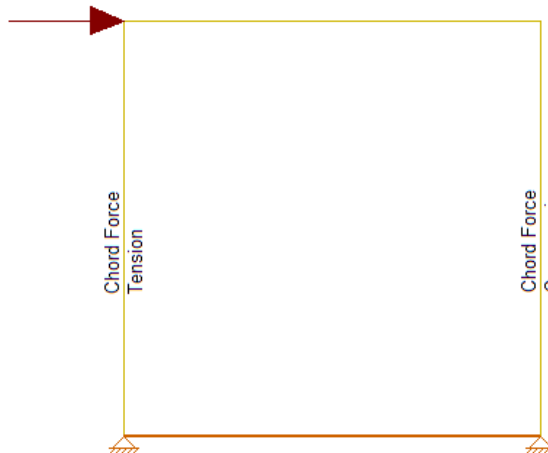

Chord forces are calculated per the following equations:

- When the ["Eccentricity" check-box](#) is selected in the Wood Wall Design Rule (Fasteners tab):

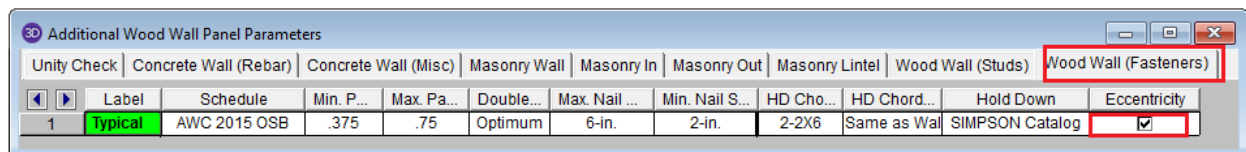

$$\text{Compression Force} = \frac{M}{L - b_c} + \frac{P}{n}$$

$$\text{Tension Force} = \frac{-M}{L - b_c} + \frac{P}{2}$$

- When the "[Eccentricity](#)" check-box is NOT selected in the Wood Wall Design Rule (Fasteners tab):

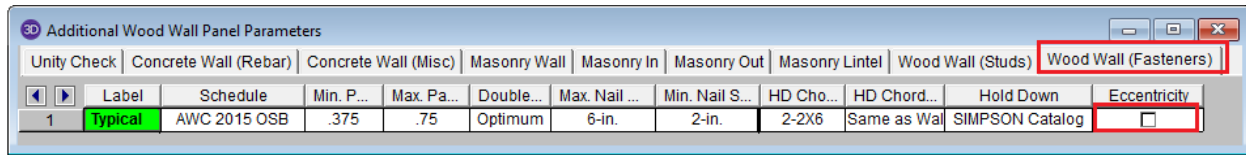

$$\text{Compression Force} = \frac{M}{L} + \frac{P}{n}$$

$$\text{Tension Force} = \frac{-M}{L} + \frac{P}{2}$$

Where:

- M = Moment at the base of the wall
- L = Length of the wall
- b_c = width of chord member
- P = Axial force at the base of the wall
- n = Number of Studs = Length/Stud Spacing

Notes:

- For Perforated Design, the term M/(Length-ChordWidth) found in the above equation is replaced with Vh/(C_oΣL₁-ChordWidth) as indicated in the Equation 4.3-8 of the NDS 2015 *Special Design Provisions for Wind & Seismic*.
- RISA-2D models the shear walls using only the sheathing. The vertical resistance occurs only at the tension and compression chords. Thus, if two wall panels are stacked on top of each other, the load transfer will only happen at the chord locations. Therefore, the lateral analysis should agree very well with hand calculations. However, it also means that gravity load design may be more appropriate in RISAFloor.

Hold-Down Force

The Hold-Down force is calculated by finding the Tension chord force. In order to accommodate an unsymmetrical vertical load on the wall, the program adopted a more accurate approach by calculating the moment at the compression side first and then finding the resulting reaction on the tension side.

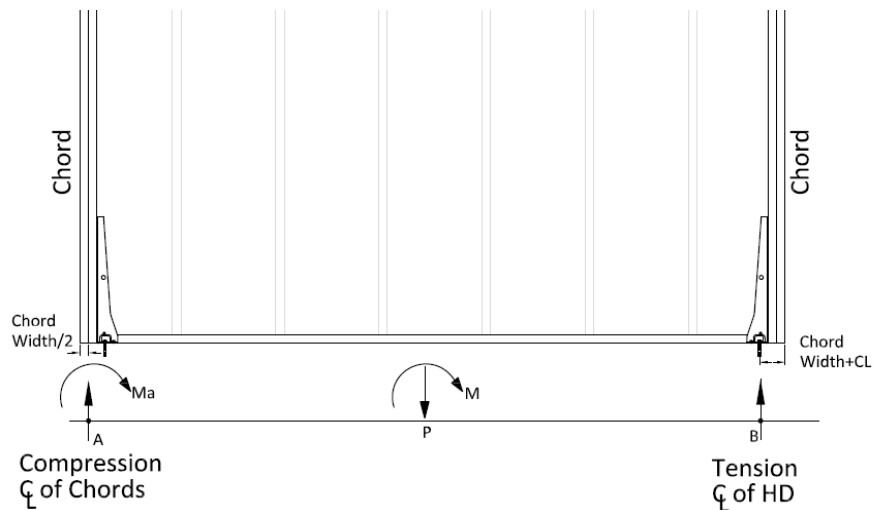

Hold-Down forces are calculated per the following equations:

- When the "[Eccentricity](#)" check-box is selected in the Wood Wall Design Rule (Fasteners tab):

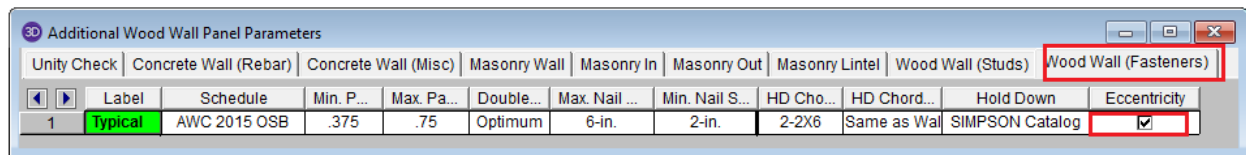

$$Moment\ at\ Point\ a = M_a = -M + \left(P * \left(\frac{L}{2} - \frac{b_c}{2} \right) \right)$$

$$Reaction\ at\ Point\ b = R_b = \frac{M_a}{L - 1.5 * b_c - CL}$$

- When the "[Eccentricity](#)" check-box is NOT selected in the Wood Wall Design Rule (Fasteners tab):

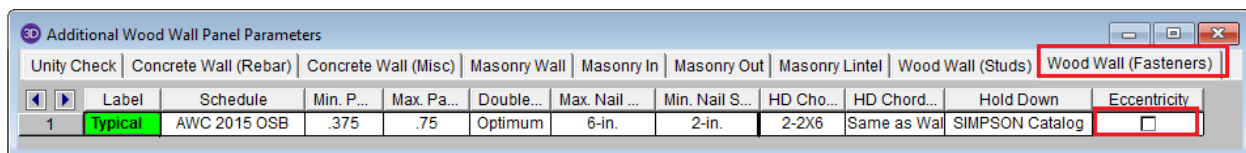

$$Moment\ at\ Point\ a = M_a = -M + \left(\frac{P * L}{2} \right)$$

$$Reaction\ at\ Point\ b = R_b = \frac{M_a}{L - CL}$$

Where:

- M_a = moment at point A (CL of compression chord)
- M = moment at base of the wall
- P = Axial load at the base of the wall
- L = length of the wall
- b_c = width of chord member
- R_b = reaction at point B = hold down force
- CL = Hold down eccentricity distance (per selected hold down)

Stud Design

Studs are only designed for load combinations which do not contain a wind or seismic load. The maximum axial load, determined as an envelope force from all of the "gravity" load combinations which have been solved, is determined for each region.

The compression capacity for the specified stud size is calculated with the assumption that the stud is fully braced against buckling about its minor axis (within the plane of the wall). This is because the blocking and sheathing are assumed to provide this bracing. The unbraced length for major axis buckling is taken as the wall height, minus the thickness of the top and sill plates.

The program divides the region axial force by the number of studs that would be present in that region for a given stud spacing. An optimal stud spacing is then selected based on the stud capacity, and the parameters defined in the [Design Rules](#).

Force Distribution

- The lateral force distribution between piers is based on the relative stiffness of the sheathing, not on the length of the shear wall. For example, if you have an 8 foot wall and a 4 foot wall, the 8 foot wall will take more than $8/(8+4)*100\%$ of the force. The moment of inertia in the 8 foot wall will allow for a larger proportion of load to go into that pier.

Shear Capacity Adjustment Factors

40% Increase Factor Wind Load Cases

The allowable shear stress values tabulated in [Appendix F](#) are intended to be the allowable shear for seismic loads. The solution tab of the Model Settings has a check-box which will automate the 40% shear capacity increase for any load combinations that include Wind Loads. This is called "**Wind ASIF**" in the detailed report output.

Allowable Stress Reductions for Slender Wall Segments

The program will modify the allowable stress of the wall based on the $2b/h$ adjustment factor per NDS SDPWS section 4.3.3.4 exception 1. This adjustment factor is only applied to the wall for load combinations which include seismic loads. This adjustment factor only affects walls with an aspect ratio between 2.0 and 3.5. This is called "**Cap.Adj. (2w/h)**" in the detailed report output.

For Segmented and FTAO wall panels designed per the NDS 2015, the program also checks the Aspect Ratio factor per section 4.3.4.2. This factor will reduce the sheathing capacity for lateral (Wind or Seismic) load combinations on walls who have a design region whose aspect ratio is greater than 2.0. This is called "**Aspect Ratio**" in the detailed report output.

The final governing factor (minimum of **Cap. Adj. (2w/h)** and **Aspect Ratio**) is reported as the **Gov. H/W Cap.** This is then multiplied by the sheathing capacity to give the final **Adjusted Cap.**

CRITERIA		MATERIALS		GEOMETRY	
Code	: AWC NDS-15:ASD	Wall Studs	: DF	Total Height	: 11 ft
		Stud Size	: 2X6	Total Length	: 5 ft
Wall Material	: DF	Chord Material	: DF	Region H/W	: 2.20
Panel Schedule	: AWC 2015 OSB	Chord Size	: 2-2X6	Cap. Adj. (2w/h)	: 0.91
Optimize HD	: Yes	Top PI & Sill	: DF	Aspect Ratio	: 0.97
HD Manufacturer:	SIMPSON	Top PI Size	: 2-2X6	Gov. H/W Cap.	: 0.91
		Sill PI Size	: 2X6	Stud Spacing	: 16 in
				K	: 1.00
				HD Eccentricity	: 4.1875 in

Specific Gravity Adjustment Factor

The NDS defines an adjustment factor associated with using stud material that is less dense than Douglas-Fir-Larch or Southern Pine. The program automatically accounts for this factor in the design of Wood Shear Walls.

Unblocked Shear Wall Adjustment Factor

Section 4.3.3.2 of the 2015 NDS *Special Design Provisions for Wind and Seismic* is ignored in RISA-3D. The program will always assume that the sheathing panel is blocked for both NDS and CSA design.

Uplift Limitation

Section 4.4 of the 2015 NDS *Special Design Provisions for Wind and Seismic* is ignored in RISA-3D. The program currently does not design wall panels for uplift forces.

Stiffness Adjustment Factors

Shear Stiffness Adjustment Factor (to change FEM results)

This stiffness adjustment factor is set on the Wall Panels spreadsheet and is intended as a way to force the FEM stiffness of the wall to more closely resemble the stiffness from the APA / NDS three term deflection equation.

This adjustment affects the stiffness of the entire wall. Therefore, for segmented walls the engineer may be forced to model the piers separately if they need to adjust the pier stiffnesses independently. In a future release, this may become an automated factor.

Green Lumber

The [Wood Wall \(Studs\)](#) tab of the Design Rules spreadsheet contains a Green Lumber check-box to account for the 50% reduction in the G_a value defined in the NDS footnote.

Stiffness Assumptions

Vertical Direction

RISA uses an orthotropic plate element to de-couple the vertical and shear stiffness of the wood walls. The vertical stiffness will be based on the E value of the studs and chords as specified in the Materials spreadsheet and the thickness of the wall. The thickness is taken as

$$\text{Thickness} = \frac{\text{Total Wall Weight}}{\text{Material Density} * \text{Wall Length} * \text{Wall Height}}$$

Where,

$$Total\ Wall\ Weight = W_{studs} + W_{chords} + W_{top\ plate} + W_{sill\ plate} + W_{sheathing\ panel}$$

In-Plane Shear

The in-plane shear stiffness will be based on the G_a value designated within the specified nailing schedule divided by the sheathing thickness. Both the G_a value and the sheathing thickness are defined in the specified sheathing schedule.

Out-of-Plane Shear

For the out of plane shear, RISA uses the same Young's Modulus (E) as used in the vertical direction and a thickness that is calculated from the out of plane moment of inertia. This becomes:

$$Thickness = \left(\frac{I_{chord} + I_{stud} + I_{panel}}{Wall\ Length} \right)^{1/3}$$

Wood Wall Self Weight

The program will calculate wood wall self weight as a sum of all the weights of the components. The material density is used to calculate the self weight of the studs, chords, top plates, sill plate, and sheathing. These are all then summed together to give the self weight of the entire wall.

Note:

- For this calculation, stud height equals wall height minus the thickness of the sill plate and the top plate.
- The number of studs is calculated using the stud spacing specified in Design Rules.

Wood Wall Optimization

The program will optimize wood walls based on the required demand forces. The program can optimize:

- Sheathing for in-plane shear design.
- Stud spacing for axial design.
- Hold-downs for in plane design.

Of these optimizations the two that substantially modifies the stiffness of the wall are the sheathing and the stud spacing. To properly adjust the stiffness requires an iterative solution that updates the stiffness of the model. This includes updating the strength properties of the wall as well as the stiffness. This optimization/iteration can be done automatically (by choosing **Yes**) or can be done manually (by choosing **No**) in the [Model Settings - Solution](#) tab.

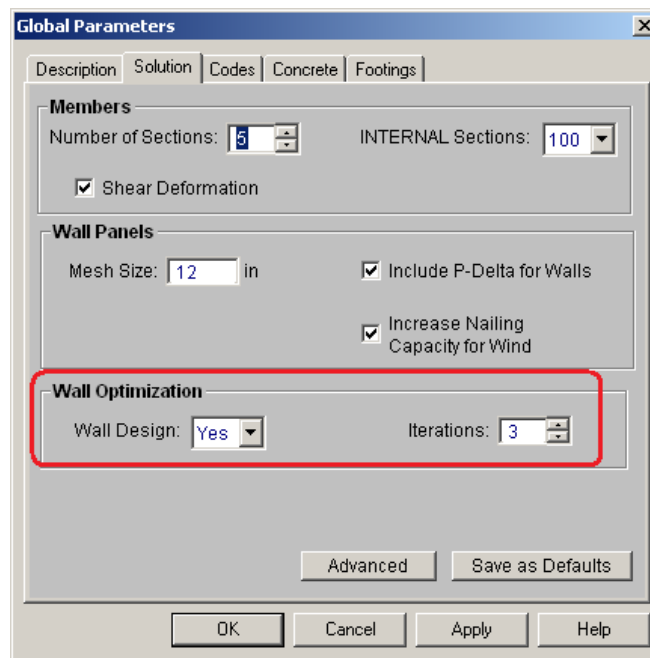

To update the stiffness portion of the wall, the program must re-solve your model with these updated stiffnesses as this will change the distribution of forces through the model. By choosing **Yes** you are telling the program to re-solve automatically. Thus, the program will start with its initial stiffness parameters and solve the model. It will then optimize the wall to meet strength criteria. Another solution will then be run with the new stiffnesses and the program will again optimize the wall to meet strength criteria. This procedure will continue to occur until you reach the number of **Iterations** set or until all wall panel results match those of the previous solution.

By choosing **No** the program will only run the solution once and the results will be based on the original configuration. You can then manually optimize your walls using the [Suggested Design](#) spreadsheet.

After the solution is run (with or without optimization) the design results are based on the stiffness used in the last iteration (by stating **No** a single iteration is run). The program will then compare the design of the last iteration with the stiffness used in that last iteration. If the two are the same the results shown are the final results. If the two are not the same the program will then provide these two different results in the **Suggested Design** spreadsheet.

The program will always present results in the output that coincide with the stiffness used in the final solution.

Note:

- The updating of the stiffness for the model is only required for the sheathing and stud spacing optimization. Thus, hold-down call-outs are optimized automatically.

Suggested Design

Wall Panel	Current Panel	Suggested Panel	Current Stud Spa[in]	Suggested Stud Spa[in]	Use Panel?	Use Stud Spa?
1 WP2	S1_3/8_8d@6	RS_(2)7/16_8d@6	16	24	<input checked="" type="checkbox"/>	<input checked="" type="checkbox"/>

In the **Suggested Design** spreadsheet you will get a list of wall panels in your model that are not yet fully optimized, showing the panel and stud spacing of the last iteration and the program optimized values. From here you have the ability to **Use Panel?** or **Use Stud Space?** which means that you want to re-run the solution with the suggested design. You can choose this for each suggestion for each wall panel individually. Once you have these checkboxes checked appropriately press the



button. After this the stiffness matrix is re-formulated and may cause some redistribution of loads through the model. Because of this the suggested design may also update and you may need to **Use Panel?** and/or **Use Stud Space?** multiple times to converge on a solution.

Note:

- If the wall does not show up in the Wood Wall Suggested Design spreadsheet then the current wall panel settings used are the optimal ones.
- If either the stud spacing or the panel fields are blank that means that the current selections are the optimal ones.
- For more information on wood wall optimization see the [Wood Wall - Design](#) topic.
- For more information on member optimization see the [Design Optimization](#) topic.
- Concrete walls do not show up here because the reinforcement optimization does not affect the stiffness of the wall.

Panel Optimization

Label	Grade	Min T...	Min Pe...	Over Gyps...	One/Tw...	Nail Size	Staple Size	Nail...	Shear Capa...
S1_5/16_6d@6	St-I	.313	1.25	No	1	6	n/a	6	.2
S1_(2)5/16_6d@6	St-I	.313	1.25	No	2	6	n/a	6	.4
S1_3/8_8d@6	St-I	.375	1.375	No	1	8	n/a	6	.23
S1_(2)3/8_8d@6	St-I	.375	1.375	No	2	8	n/a	6	.46
S1_7/16_8d@6	St-I	.438	1.375	No	1	8	n/a	6	.255
S1_(2)7/16_8d@6	St-I	.438	1.375	No	2	8	n/a	6	.51
S1_15/32_8d@6	St-I	.469	1.375	No	1	8	n/a	6	.28
S1_(2)15/32_8d@6	St-I	.469	1.375	No	2	8	n/a	6	.56
S1_15/32_10d@6	St-I	.469	1.5	No	1	10	n/a	6	.34
S1_(2)15/32_10d@6	St-I	.469	1.5	No	2	10	n/a	6	.68
S1_5/16_6d@4	St-I	.313	1.25	No	1	6	n/a	4	.3
S1_(2)5/16_6d@4	St-I	.313	1.25	No	2	6	n/a	4	.6
S1_3/8_8d@4	St-I	.375	1.375	No	1	8	n/a	4	.36
S1_(2)3/8_8d@4	St-I	.375	1.375	No	2	8	n/a	4	.72
S1_7/16_8d@4	St-I	.438	1.375	No	1	8	n/a	4	.395
S1_(2)7/16_8d@4	St-I	.438	1.375	No	2	8	n/a	4	.79
S1_15/32_8d@4	St-I	.469	1.375	No	1	8	n/a	4	.43

The procedure that RISA uses for design optimization is fundamentally based upon the assumption that there is a 'cost' to shear capacity, and therefore the ideal panel design would have as little shear capacity as possible to meet code requirements. Once the program has determined the shear demand on the wall it will choose the most economical panel configuration based on that which has a **Shear Capacity** closest to, but not exceeding the shear demand.

The default shear panels in the program come straight from published tables in the IBC, UBC, and CSA O86 design manuals. "St-I" refers to Structural I panels and "RS" refers to Rated Sheathing panels.

Note:

- The shear force listed in the XML spreadsheet is tabulated for the seismic values. These values will automatically be multiplied by 1.4 for wind forces if the [Wind ASIF](#) function is enabled.
- Panels with a label containing the characters "_W" together will be ignored during design optimization.
- "Rated Sheathing" is a shortened form of "Span Rated Sheathing" or APA Rated Sheathing. This terminology comes directly from the Department of Commerce standards DOC PS1 and PS2.

Hold Down Optimization

Hold Down Schedule

Select Manufacturer: Simpson HoldDowns

Available HD Series: SIMPSON Catalog, HDU_DF-SP, HDU_SPF-HF, HDB_DF-SP, HDB_SPF-HF, HTT_DF-SP, HTT_SPF-HF

Label	Manufact...	Min Ch...	Reqd C...	Bolt Siz...	Defl at ...	CD Factor	Allowable...	CL[in]
HDU2-SDS2.5...	SIMPSON	3	DF	.625	.088	1.600	3.075	1.313
HDU4-SDS2.5...	SIMPSON	3	DF	.625	.114	1.600	4.565	1.313
HDU5-SDS2.5...	SIMPSON	3	DF	.625	.115	1.600	5.645	1.313
HDU8-SDS2.5...	SIMPSON	3	DF	.875	.11	1.600	6.765	1.375
HDU8-SDS2.5...	SIMPSON	3.5	DF	.875	.116	1.600	6.97	1.375
HDU8-SDS2.5...	SIMPSON	4.5	DF	.875	.113	1.600	7.87	1.375
HDU11-SDS2....	SIMPSON	5.5	DF	1	.137	1.600	9.335	1.375
HDU11-SDS2....	SIMPSON	7.25	DF	1	.137	1.600	11.175	1.375
HDU14-SDS2....	SIMPSON	3.5	DF	1	.122	1.600	10.77	1.563
HDU14-SDS2....	SIMPSON	7.25	DF	1	.177	1.600	14.39	1.563
HDU14-SDS2....	SIMPSON	5.5	DF	1	.172	1.600	14.445	1.563
HDU2-SDS2.5...	SIMPSON	3	HF	.625	.088	1.600	2.215	1.313
HDU4-SDS2.5...	SIMPSON	3	HF	.625	.114	1.600	3.285	1.313
HDU5-SDS2.5...	SIMPSON	3	HF	.625	.115	1.600	4.065	1.313
HDU8-SDS2.5...	SIMPSON	3	HF	.875	.11	1.600	4.87	1.375
HDU8-SDS2.5...	SIMPSON	3.5	HF	.875	.116	1.600	5.02	1.375
HDU8-SDS2.5...	SIMPSON	4.5	HF	.875	.113	1.600	5.665	1.375
HDU11-SDS2....	SIMPSON	5.5	HF	1	.137	1.600	6.865	1.375

Current Selection Type: Use Entire Series SERIES

Buttons: Save As Defaults, OK, Cancel, Help

The procedure that RISA uses for hold-down optimization is fundamentally based upon the assumption that there is a 'cost' to allowable tension in a product, and therefore the ideal hold-down would have as little tensile capacity as possible to meet code requirements. Once the program has determined the tensile force required to hold-down the wall it will choose the most economical hold-down product based on that which most closely matches (but does not exceed) the tension demand. The program looks to the **Allowable Tension** field of the hold-down schedule to choose the design.

Strap Optimization

Strap Schedule

Select Manufacturer: Simpson Chord Straps

Available Strap Series: SIMPSON Catalog, CMST_DF-SP, CMST_SPF-HF, CS_DF-SP, CS_SPF-HF, MST_DF-SP, MST_SPF-HF, HST_DF-SP, HST_SPF-HF

Label	Manufact...	Clear S...	End Le...	Reqd C...	Fasten...	Numbe...	Fasten...	CD Factor	Allowable...
MSTA49_18_...	SIMPSON	18	n/a	DF/SP	Nail	26	10d	1.6	2.02
MSTA49_16_...	SIMPSON	16	n/a	DF/SP	Nail	26	10d	1.6	2.02
MSTC28_18_...	SIMPSON	18	n/a	DF/SP	Nail	12	16d_si...	1.6	1.155
MSTC28_16_...	SIMPSON	16	n/a	DF/SP	Nail	16	16d_si...	1.6	1.54
MSTC40_24_...	SIMPSON	24	n/a	DF/SP	Nail	20	16d_si...	1.6	2.31
MSTC40_18_...	SIMPSON	18	n/a	DF/SP	Nail	28	16d_si...	1.6	2.695
MSTC40_16_...	SIMPSON	16	n/a	DF/SP	Nail	32	16d_si...	1.6	3.08
MSTC52_24_...	SIMPSON	24	n/a	DF/SP	Nail	36	16d_si...	1.6	3.465
MSTC52_18_...	SIMPSON	18	n/a	DF/SP	Nail	44	16d_si...	1.6	4.235
MSTC52_16_...	SIMPSON	16	n/a	DF/SP	Nail	48	16d_si...	1.6	4.62
MSTC66_30_...	SIMPSON	30	n/a	DF/SP	Nail	48	16d_si...	1.6	4.78
MSTC66_24_...	SIMPSON	24	n/a	DF/SP	Nail	54	16d_si...	1.6	5.38
MSTC66_18_...	SIMPSON	18	n/a	DF/SP	Nail	64	16d_si...	1.6	5.86
MSTC66_16_...	SIMPSON	16	n/a	DF/SP	Nail	68	16d_si...	1.6	5.86
MSTC78_30_...	SIMPSON	30	n/a	DF/SP	Nail	64	16d_si...	1.6	5.86
MSTC78_24_...	SIMPSON	24	n/a	DF/SP	Nail	72	16d_si...	1.6	5.86
MSTC78_18_...	SIMPSON	18	n/a	DF/SP	Nail	76	16d_si...	1.6	5.86
MST37_24_D...	SIMPSON	24	n/a	DF/SP	Nail	14	16d	1.6	1.725

Current Selection Type: Use Entire Series SERIES

Buttons: Save As Defaults, OK, Cancel, Help

The procedure that RISA uses for strap optimization is fundamentally based upon the assumption that there is a 'cost' to allowable tension in a product, and therefore the ideal strap would have as little tensile capacity as

possible to meet code requirements. Once the program has determined the tensile force required to strap down the wall it will choose the most economical strap product based on that which most closely matches (but does not exceed) the tension demand. The program looks to the **Allowable Tension** field of the strap schedule to choose the design.

Optimization Options

For users who are new to wood wall design within RISA, the best procedure is to utilize the full databases, and to limit the potential designs by utilizing the [design rules spreadsheets](#). This results in a design based on the maximum number of options, which is often the most efficient design.

For experienced users who have more specific limitations in terms of the designs they would like to see, user-defined **Groups** (or families) are the solution. For example, an engineer who prefers to use only one sheathing thickness, or one nail type can create a custom Group that contains only the arrangements they want. For more information on creating these custom groups see [Appendix F-Wood Shear Wall Files](#).

For more information on Wood Walls see [Wood Wall Results](#).

Wood Wall - Design Rules

The wood wall panel element allows you to easily model, analyze and design wood walls for in plane loads. Here we will explain the wood specific inputs and design considerations. For general wall panel information, see the [Wall Panels](#) topic. For information on wood wall design considerations, see the [Wood Wall - Design](#) topic. For wood wall results interpretation, see the [Wood Wall Results](#) topic.

Unity Check

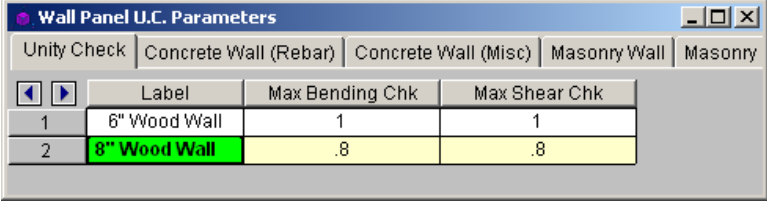

Wall Panel U.C. Parameters			
Unity Check Concrete Wall (Rebar) Concrete Wall (Misc) Masonry Wall Masonry			
	Label	Max Bending Chk	Max Shear Chk
1	6" Wood Wall	1	1
2	8" Wood Wall	.8	.8

Max Bending Chk

This will define the hold-down maximum code check value. Typically this will always be 1.0, but this allows the option of having the program pick out a hold-down that is not at maximum capacity. Putting a value of 0.8 will choose a hold-down that is at 80% of capacity.

Max Shear Chk

This will define the shear panel selection maximum code check value. Typically this will always be 1.0, but this allows the option of having the program pick out a shear panel layout that is not at maximum capacity. Putting a value of 0.8 will choose a panel thickness and nailing that is at 80% of capacity.

Wood Wall (Studs)

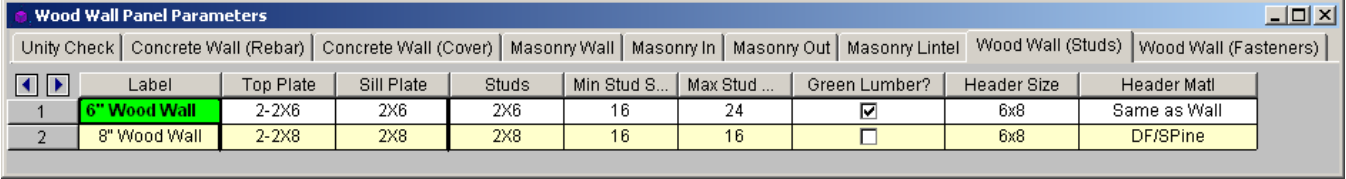

Wood Wall Panel Parameters									
Unity Check Concrete Wall (Rebar) Concrete Wall (Cover) Masonry Wall Masonry In Masonry Out Masonry Lintel Wood Wall (Studs) Wood Wall (Fasteners)									
	Label	Top Plate	Sill Plate	Studs	Min Stud S...	Max Stud ...	Green Lumber?	Header Size	Header Matl
1	6" Wood Wall	2-2X6	2X6	2X6	16	24	<input checked="" type="checkbox"/>	6x8	Same as Wall
2	8" Wood Wall	2-2X8	2X8	2X8	16	16	<input type="checkbox"/>	6x8	DF/SPine

Top Plate

Use the Top Plate column to specify the member to be used as a top plate for your wall. A top plate is a member that runs continuously along the top of the wall studs. Note that you can use multiple plies of nominal lumber, or custom shapes.

Sill Plate

Use the Sill Plate column to specify the member to be used as a sill plate for your wall. A sill plate is a member that runs continuously along the bottom of the wall studs. Note that you can use multiple plies of nominal lumber, or custom shapes.

Studs

Use the Studs column to specify the member to be used for studs in your wall. Studs are vertical members in the wall, attached to the sill plate at the bottom and the top plate at the top. Note that you can use multiple plies of nominal lumber, or custom shapes.

Min/Max Stud Space

You may specify a minimum and maximum spacing of wall studs. The program can then optimize the stud spacing based on axial design only. For information on how the optimization works, see the [Wood Wall - Design](#) topic.

- If you specify the maximum and minimum stud spacing as the same value, then we will use that value exclusively.
- Out of plane design is not performed for wood walls, so any optimization is based only on axial forces in the studs.

Green Lumber

NDS Design: Check this box if your moisture content is greater than 19%. The program will then multiply the G_a value of the shear panel by 0.5 per Note 5 of Tables 4.3A and 4.3B of the NDS SDPWS.

CSA O86 Design: Check this box if you have wet service conditions. This will effect the Service Condition Factors, K_s per CSA O86-14 Table 6.4.2.

Header Size

This defines the default header size for all openings. Note that this can be modified in the [Wall Panel Editor](#) by double-clicking the opening and choosing **Custom**.

Header Matl

By default we will use the same material for the header as we are for the studs, chords, etc. However, you can change the material here.

Design Rules - Wood Wall (Fasteners)

	Label	Schedule	Min. Panel...	Max. Panel...	Double Si...	Max. Nail ...	Min. Nail S...	HD Chords	HD Chord ...	Hold Down	Chord Strap	Eccent...
1	Bearing Wall	AWC 2015 OSB	.375	.75	Optimum	6-in.	2-in.	2-2X6	Same as Wall	SIMPSON Catalog	SIMPSON Catalog	<input checked="" type="checkbox"/>
2	Shear Wall	AWC 2015 OSB	.375	.75	Optimum	6-in.	2-in.	2-2X6	Same as Wall	CAN SIMPSON Catalog	SIMPSON Catalog	<input checked="" type="checkbox"/>
3	12" Masonry	AWC 2015 OSB	.375	.75	Optimum	6-in.	2-in.	2-2X6	Same as Wall	CAN SIMPSON Catalog	SIMPSON Catalog	<input checked="" type="checkbox"/>
4	4" Wood	AWC 2015 OSB	.375	.75	Optimum	6-in.	2-in.	2-2X6	Same as Wall	CAN SIMPSON Catalog	SIMPSON Catalog	<input checked="" type="checkbox"/>
5	6" Wood	AWC 2015 OSB	.375	.75	Optimum	6-in.	2-in.	2-2X6	Same as Wall	CAN SIMPSON Catalog	SIMPSON Catalog	<input checked="" type="checkbox"/>

Schedule

You can select the Code, and Panel Group you would like to use for design optimization. By unchecking the **Select Entire Panel Group** box an individual panel type may be assigned. For information on how the optimization works, see the [Wood Wall - Design](#) topic. For more information on this schedule, as well as information on how to edit or create your own custom schedule, see [Appendix F-Wood Design Databases](#)

Min/Max Panel Thick

These values set minimums and maximums for the thickness of the sheathing that will be designed. If the same value is input for both max and min, then that will be the thickness used.

Double Sided

You can choose whether you want the program to force sheathing on only one side of the panel, both sides, or to choose the optimum based on weight.

Max/Min Nail Spacing

These values set minimums and maximums for the spacing of the nails that fasten the sheathing to the boundary members (top plate, sill plate, hold down chords). Note that a 12" spacing is assumed for all field nailing (nails fastening the sheathing to the internal studs).

HD Chords

You can choose what member size you would like to use for the Hold Down Chords (Posts) at both ends of the wall panel.

HD Chord Material

You can specify whether the hold down chords are of the same material as the wall, or another material.

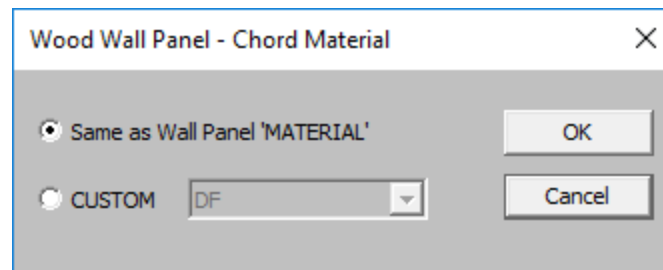

Hold Down

You can select the Code, and Hold Down Series you would like to use for design optimization. By unchecking the **Use Entire Series** box you may select an individual hold down product to be assigned. For information on how the optimization works, see the [Wood Wall - Design](#) topic. For more information on this schedule, as well as information on how to edit or create your own custom schedule, see [Appendix F-Wood Shear Wall Files](#)

Chord Strap

You can select the Manufacturer and Strap Series you would like to use for design optimization. By unchecking the **Use Entire Series** box you may select an individual strap product to be assigned. For information on how the optimization works, see the [Wood Wall - Design](#) topic. For more information on this schedule, as well as information on how to edit or create your own custom schedule, see [Appendix F-Wood Shear Wall Files](#)

Eccentricity

You can choose to include the eccentricity of the Hold-Down location by checking the "Eccentricity" check-box in this spreadsheet. This is used in calculating the [Chord forces](#) and the [Hold Down force](#). The Hold-Down center-line is defined in the Hold-down database.

If the "Eccentricity" check-box is left unchecked the program will use the full length of the wall (ignoring the chord thicknesses and the hold down eccentricity).

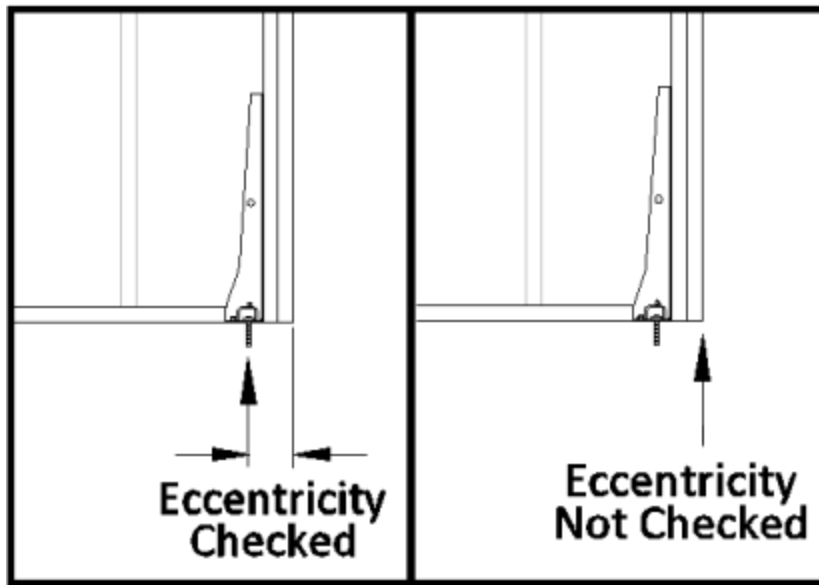

Note:

- **Eccentricity** option is only applicable to hold-downs, not straps.

Wood Wall Results

Wood Wall results are presented in the **Wall Panel Design Spreadsheet** and the detail reports.

For additional advice on this topic, please see the RISA Tips & Tricks webpage at risa.com/post/support. Type in Search keywords: **Wood Walls**.

Wood Wall Results Spreadsheets

Wood Wall Axial Results

Wall Panel	Region	Stud Size	Stud Spaci...	Axial Check	Gov LC	Chord Size	Chord Axial C...	Gov LC	
1	WP2	R1	2X6	16	.005	1	2-2X6	.017	1
2		R2	2X6	NC	NC	NC	2-2X6	NC	NC
3		R3	2X6	NC	NC	NC	2-2X6	NC	NC
4		R4	2X6	16	.011	1	2-2X6	.024	1

The **Wall Panel** column lists the wood wall panels that you have defined.

The **Region** column lists the wall panel region that the results are based on.

Note:

- For [Perforated](#) or [Force Transfer Around Openings](#) design methods, regions are not used. Thus, an N/A will be displayed.

The **Stud Size and Spacing** columns show the optimum stud size and spacing chosen for your wall, based on the [Design Rules](#) you have defined.

The **Axial Check** value is a code check ratio between the member load and the member capacity. The adjacent **Gov LC** column shows the governing load combination for the design.

The **Chord Size** column shows the optimum chord size chosen for your wall, based on the [Design Rules](#) you have defined. Note that the chords are the vertical hold-down members/posts at the both ends of the wall.

The **Chord Axial Check** value is a code check ratio between the member load and the member capacity. The adjacent **Gov LC** column shows the governing load combination for the design.

Note:

- When running the [Segmented](#) design method, the wall panel regions above and below the opening are not considered in design. Thus an NC (no calculation) will be displayed.
- If there are some constraints that will not allow a wall to be designed, an NC (no calculation) will be displayed. Check the **Warning Log** within the program for more information on this.

Wood Wall In-Plane Results

Wall Panel	Shear Panel Label	Region	Shear Check	Shear Force/ft	Gov LC	Hold-Down	Tension Check	Tie-Down Force/ft	Gov LC	
1	WP1	RS_2116_84@8	R1	9797	2351	23	HDA_1.5_DF	9324	2.1235	20
2	WP2	RS_2116_84@8	R1	9882	2372	28	HDA_1.5_DF	9399	1.7415	28
3	WP3	RS_2116_84@8	R1	9944	2387	12	HDA_1.5_HF	9818	1.422	28
4	WP4	RS_2116_84@8	R1	9867	2368	12	HDA_1.5_HF	9355	1.5588	28
5	WP5	ST_1512_84@8	R1	9319	2609	28	HDA_1.5_HF	4895	7312	20

The **Shear Panel Label** shows the optimum shear panel arrangement chosen for your wall, based on the [Design Rules](#) you have defined.

The **Region** gives the region for which the design values are being displayed.

Note:

- The [Perforated](#) and [Force Transfer Around Openings](#) methods do not consider regions in their design, thus N/A is displayed.

The **Shear Check** value is a code check ratio between the panel shear load and the panel shear capacity. The **Shear Force** and **Gov LC** show the values and load combination which governed the design.

The **Hold-Down Label** shows the optimum hold-down product chosen for your wall, based on the [Design Rules](#) you have defined.

The **Chord Strap Label** shows the optimum strap product chosen for your wall, based on the [Design Rules](#) you have defined.

The **Tension Check** value is a code check ratio between the tension load and the hold-down tensile capacity. This column will only be populated for wood walls at the base level of the structure. The program does not do wall to wall strap design.

The **Tie-Down Force** and **Gov LC** show the maximum value of hold-down/strap and the load combination which produced the highest strap force. This maximum force could occur on either end of the wall/region.

Note:

- When running the [Segmented](#) design method, the wall panel regions above and below the opening are not considered in design. Thus an NC (no calculation) will be displayed. If running a combined RISAFloor and RISA-3D model use RISAFloor to get header results.
- If there are some constraints that will not allow a wall to be designed, an NC (no calculation) will be displayed. Check the **Warning Log** within the program for more information on this.
- If 'default' is shown in the **Hold-Down Label** column it means that a hold down is not required for this wall/region.

Wood Wall Header Results

Wall Panel	Header La...	Design Ru...	Size	Bend UC	Shear UC	Gov LC	
1	WP1	L1	Typical	2X4	.023	.032	1 (shear)

The **Header Label** gives the label of your header. If there is more than one header in a wall you can see which is which in the wall panel editor.

The **Design Rule** gives the rule that is defining the size and material.

The **Size** gives the size from the Design Rule.

The **Bend UC** value is a bending code check ratio. This is given for the load combination from the Gov LC column.

The **Shear UC** value is a shear code check ratio. This is given for the load combination from the Gov LC column.

The **Gov LC** gives the load combination that governed the design. The program finds the largest UC value for either bending or shear and reports the associated load combination here.

Note:

- The **Bend UC** and **Shear UC** are always given for the SAME load combination. Whichever load combination produced the highest code check for either bending or shear will have its results shown in these columns.
- The program will only design wood headers for non-EL and non-WL load combinations.

Wood Wall Self Weight

The program will calculate the self weight of a wood wall based on the weights of the individual components. Using the material density, the self weight is calculated for the studs, chords, top plates, sill plates, and sheathing. These are all then summed for the total self weight of the wall.

Wood Wall Detail Reports



The detail report gives detailed information about the wall design. The detail reports are specifically molded to the type of design specified. Here we will walk through how to access the different information for each of the types of design: [Segmented](#), [Perforated](#) and [Force Transfer Around Openings](#).

Note:

- RISAFloor only considers the **Segmented** design method. If using RISAFloor together with RISA-3D, simply taking your model into RISA-3D will open up the **Perforated** and **Force Transfer Around Openings** design methods.
- Many of the values for design checks seen below are not performed in RISAFloor as it is strictly a gravity design program.

Accessing the Detail Reports and the Specific Windows

Once you have a solved model, the detail reports become available. They are accessible in two ways:



1. If you have the **Wall Panel Design** spreadsheet open, you can right-click on a line in the spreadsheet and select **Detailed Report**. there will be a button at the top of the screen: . This will open up the detail report window.
2. If you are in a graphic view of your model, there is a  button that will open up the detail report window.

Note:

- Detail report information is not available for an envelope solution.

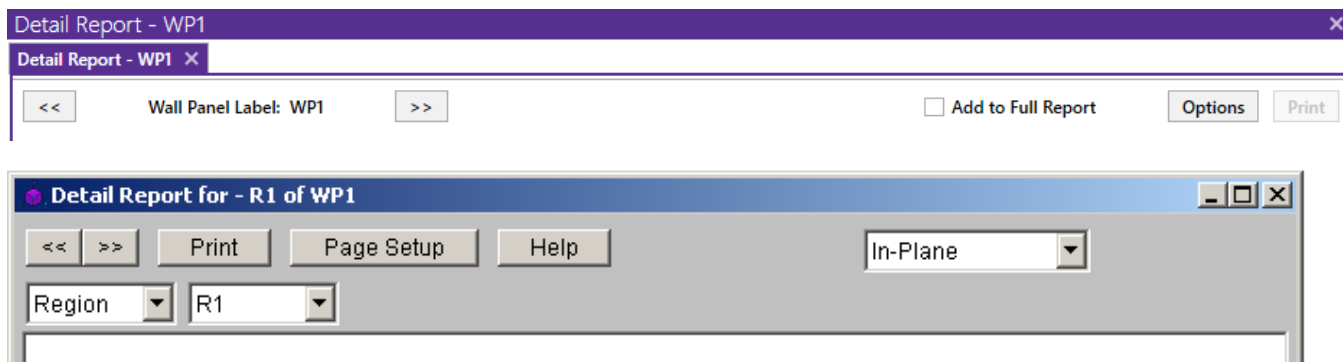
Once the detail report window is open, you will see a dialog area at the top.



-  - Allows you to click between the different wall panels in your model.
-  - This button will allow you to take a snapshot of the current detail report you are viewing so that it can be added to a report. View the [Printing](#) topic for more information.

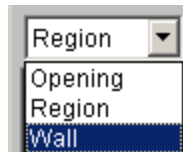

- - This dropdown list allows you to select between the three different parts of the wood wall panel detail report. Below we will explain the importance of each of these sections.



- - This dropdown list allows you to select between different regions or headers defined within the individual wall panel.

The Wall detail report gives an overall summary of your wall, complete with governing code checks and opening information. The Opening detail report gives information to the header design for the opening as well as detailed information for the **Force Transfer Around Openings** method. The Region detail report only applies for **Segmented** walls. Below we have give detailed information on each type of design: [Segmented](#), [Perforated](#) and [Force Transfer Around Openings](#).

Segmented Method

The **Segmented** design method uses each of the three detail report windows to give design information.

Wall Window

This window gives an overview of the wall, giving controlling region information and deflection information. Note that this window only gives information on the full-height segments in your wall, as this is the basis of the **Segmented** method.

Input Echo

GENERAL		GEOMETRY		MATERIALS		
Code	: AWC NDS-15:ASD	Total Height	: 12 ft	Description	Material	Size
Design Method	: Segmented	Total Length	: 20 ft	Top Pl	DF	2-2X6
Wall Material	: DF	Max H/W Ratio	: 3.43	Sill	DF	2X6
Panel Schedule	: IBC06-09 Panel Data... K		: 1.00	Wall Stud	DF	2X6
Sel. Shear Panel	: RS_7/16_8d@6			Chord	DF	2-2X6

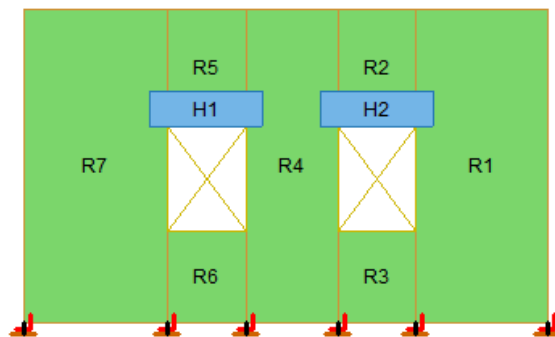

Detail Report - WP1

Detail Report - WP1 X

<< Wall Panel Label: WP1 >>

Add to Full Report Options Print

Input Data:

Code: AWC NDS-18: ASD
 Design Method: Segmented
 Height (ft): 7
 Length (ft): 8
 Wall Material: Douglas Fir-Larch No.1
 Panel Schedule: AWC 2015 OSB
 Sel. Shear Panel: S1_(2)15/32_10d@2

Wall Properties:

Top Plate: 2-2X6
 Sill: 2X6
 Wall Stud: 2X6
 Chord: 2-2X6
 Max H/W Ratio: 3.50
 K: 1

Material Properties:

Top Plate:	Douglas Fir-Larch No.1	Fb (ksi):	1	Ft (ksi):	0.675
Sill:	Douglas Fir-Larch No.1	Fv (ksi):	0.18	* All values per 2015 NDS Supplement Table 4A (Reference Design Values for Visually Graded Dimension Lumber)	
Wall Stud:	Douglas Fir-Larch No.1	Fc (ksi):	1.5		
Chord:	Douglas Fir-Larch No.1				
E:	1700	Density (k/ft ³):	60.48		

Close

This lists information about the wall, similar to the [Region](#) report and also gives an image of the wall. The image shows the location of hold-downs/straps, regions and headers.

Design Details

DESIGN DETAILS

ENVELOPED RESULTS

Controlling Shear Region	Shear Panel	Shear UC	Shear LC	Controlling Hold-down	Hold-down UC	Hold-down LC	Chord UC	Chord LC	Stud UC	Stud LC
R1	RS_3/8_8d@6	0.933	13 (S)	HD2A_1.5...	0.540	46 (S)	0.364	2	0.426	2

REGION INFORMATION

Full-Height Region Label	HW Ratio	Shear UC	Shear LC	Hold-down	Hold-down UC	Hold-down LC	Chord UC	Chord LC	Stud UC	Stud LC
R1	2.86	0.933	13 (S)	HD2A_1.5_HF_F	0.418	48 (S)	0.121	10 (W)	0.087	2
R4	1.54	0.768	13 (S)	Not Req'd	NC	NC	0.364	2	0.426	2
R7	1.67	0.804	15 (S)	Not Req'd	NC	NC	0.166	2	0.314	2
R10	2.00	0.693	15 (S)	HD2A_1.5_HF_F	0.540	46 (S)	0.173	10 (W)	0.131	2

OPENING INFORMATION

Headers of openings are not designed for Segmented walls.
Please choose Perforated or FTAO design method to get header design.

DEFLECTION RESULTS

Maximum Region Deflection (in)	Deflection LC	Finite Element Deflection (in)	Shear Stiffness Adjustment Factor (SSAF)
.169 (R7)	15	.211	1

Design Summary: Enveloped Results

Limit State	Gov. LC	Required	Available	Unity Check	Result
Controlling region					PASS
Controlling region R4					
ShearPanel					
RS_3/8_6d@6	1 (S)	0.01 k/ft	0.162 k/ft	0.050	PASS
Chord Straps / Hold Downs					
Strap / Hold Down Manufacturer :					
Not Req'd	NC			NC	
Chords					
2-2X6 (Compression)	1 (S)	1.251 k	14.702 k	0.085	PASS
2-2X6 (Compression)	1 (S)	1.222 k	14.702 k	0.000	PASS
Studs					
2X6	1 (S)	1.587 k	10.176 k	0.156	PASS

Deflection Results

Maximum Region Deflection (in)	Gov. LC	Finite element Deflection (in)	Shear Stiffness Adjustment Factor (SSAF)
0.007(R4)	1 (S)	0.001	1

Region Design

	Shear UC	Strap / Hold-Down UC	Chord UC	Stud UC	Result
R1 (In-Plane)	0.027	NC	0.085	0.119	PASS
R2 (In-Plane)	No design for regions above or below the openings in segmented walls.				
R3 (In-Plane)	No design for regions above or below the openings in segmented walls.				
R4 (In-Plane)	0.05	NC	0.11	0.156	PASS

The **Enveloped Results** gives the code checks for all of the controlling elements in the wall and their associated load combinations.

The **Region Information** gives the tabulated results of all of the full-height regions in your wall.

The **Opening Information** simply states that header design cannot be completed with the **Segmented** method. The regions above and below the opening have their shear stiffnesses set to be zero and this causes the header forces to be invalid.

The **Deflection Results** gives both the calculated NDS deflection (Maximum Region Deflection) and the FE deflection for use as a means of comparison. Because the NDS/CSA O86 equations are empirical and take into account many non-elastic considerations such as nail slip, these two values may not be the same. The use of the [SSAF](#) helps to make these two values similar.

Opening Window

This window defines the openings in the wall. The segmented wall design method assumes zero stiffness over the opening, therefore, there is no header design for a Segmented wall with openings. Walls specified as a Perforated or FTAO can be analyzed for a header design.

Region Window

This window gives information for your wall on a region by region basis. Note that only full-height regions of the wall panel will have a region detail report. The **Segmented** method only considers these full height segments in the design of the wall.

The region detail report is split into four portions: [input echo](#), [diagrams and design](#), [design details](#), and [cross section detailing](#). Note that in RISAFloor the detail reports are less detailed because RISAFloor does not consider lateral forces which RISA-3D does.

Input Echo

Below is the input echo portion of the detail report.

Criteria	Description
Code	Gives the code used to design your wall panel.
Wall Material	Specifies the wood type assigned to the entire wall
Panel Schedule	Specifies the sheathing/nailing schedule database used to optimize panel selection (set in Design Rules)
Optimize HD	Shows whether or not the program needed to optimize the hold-down, or if the user explicitly defined a hold down
HD Manufacturer	Specifies the manufacturer of chosen hold-down
Strap Manufacturer	Specifies the manufacturer of chosen strap

Materials	Description
Wall Studs	Specifies the wood material type assigned to the wall studs
Stud Size	Specifies the member size used for the wall studs
Chord Material	Specifies the wood material type assigned to the chords (vertical members at both ends of the wall)
Chord Size	Specifies the member size used for the chords (vertical members at both ends of the wall)
Top Plate & Sill	Specifies the wood material type assigned to the top and sill plates
Top Plate Size	Specifies the member size used for the top plate
Sill Plate Size	Specifies the member size used for the sill plate

Geometry	Description
Total Height	This is the height of the wall panel region
Total Length	This is the length of the wall panel region
Region H/W Ratio	This is the ratio of wall height to length, using the minimum wall height
Cap. Adj (2w/h)	This is an aspect ratio reduction factor for the shear panel strength per NDS SDPWS section 4.3.3.4 Exception 1 (2015). This factor applies only for seismic loads, thus it will be 1.0 for wind load combinations per NDS SDPWS section 4.3.4.1 (2005/8). This factor is applied separately for each full-height region in your wall.
Aspect Ratio	This is an aspect ratio reduction factor for the shear panel strength per NDS SDPWS section 4.3.4.2 (2015). This factor applies only for seismic and wind loads on Segmented or FTAO walls. This factor is applied separately for each region in your wall.
Gov. H/W Cap.	This is the governing (minimum) factor per the Cap. Adj (2w/h) and Aspect Ratios shown above. Only the minimum shall apply per NDS SDPWS section 4.3.3.4 Exception 1.
Wind ASIF	The code gives a 40% increase in the tables if the lateral load is wind over seismic. For seismic loads this ASIF will be 1.0 (only applicable to NDS design).
Stud Spacing	This is the optimized stud spacing based on your Design Rules
K	This is the effective length, K Factor used for stud and chord compression design
HD Eccentricity	This is the eccentricity of the hold-down connection. This is based on the manufacturer's catalog and measured as the distance from the center of the chord to the hold-down bolt

Diagrams and Design

ENVELOPE DIAGRAMS

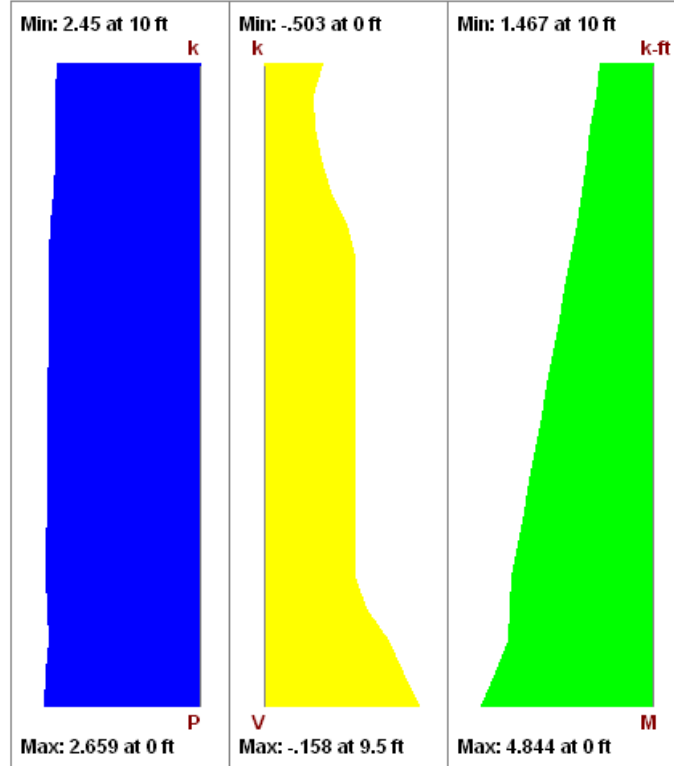

DESIGN SUMMARY

SHEAR PANEL	
Required Cap	: .144 k/ft
Provided Cap	: 0.154 k/ft
Ratio	: .933
Governing LC	: 13 (Seismic)
CHORDS	
Max Comp Force	: 1.787 k
Comp Capacity	: 14.825 k
Comp Ratio	: .121
Gov Comp LC	: 10
Max Tens Force	: .664 k
Tens Capacity	: 20.27 k
Tens Ratio	: .033
Gov Tens LC	: 48
STUDS	
Required Cap	: .665 k
Provided Cap	: 7.62 k
Ratio	: .087
Governing LC	: 2
HOLD-DOWNS	
Required Cap	: .664 k
Provided Cap	: 1.588 k
Ratio	: .418
Governing LC	: 48
DEFLECTIONS	
Flexure Comp	: .012 in
Shear Comp	: .085 in
HD Elong	: .04 in
Tot Deflection	: .136 in
Governing LC	: 13

Region Design

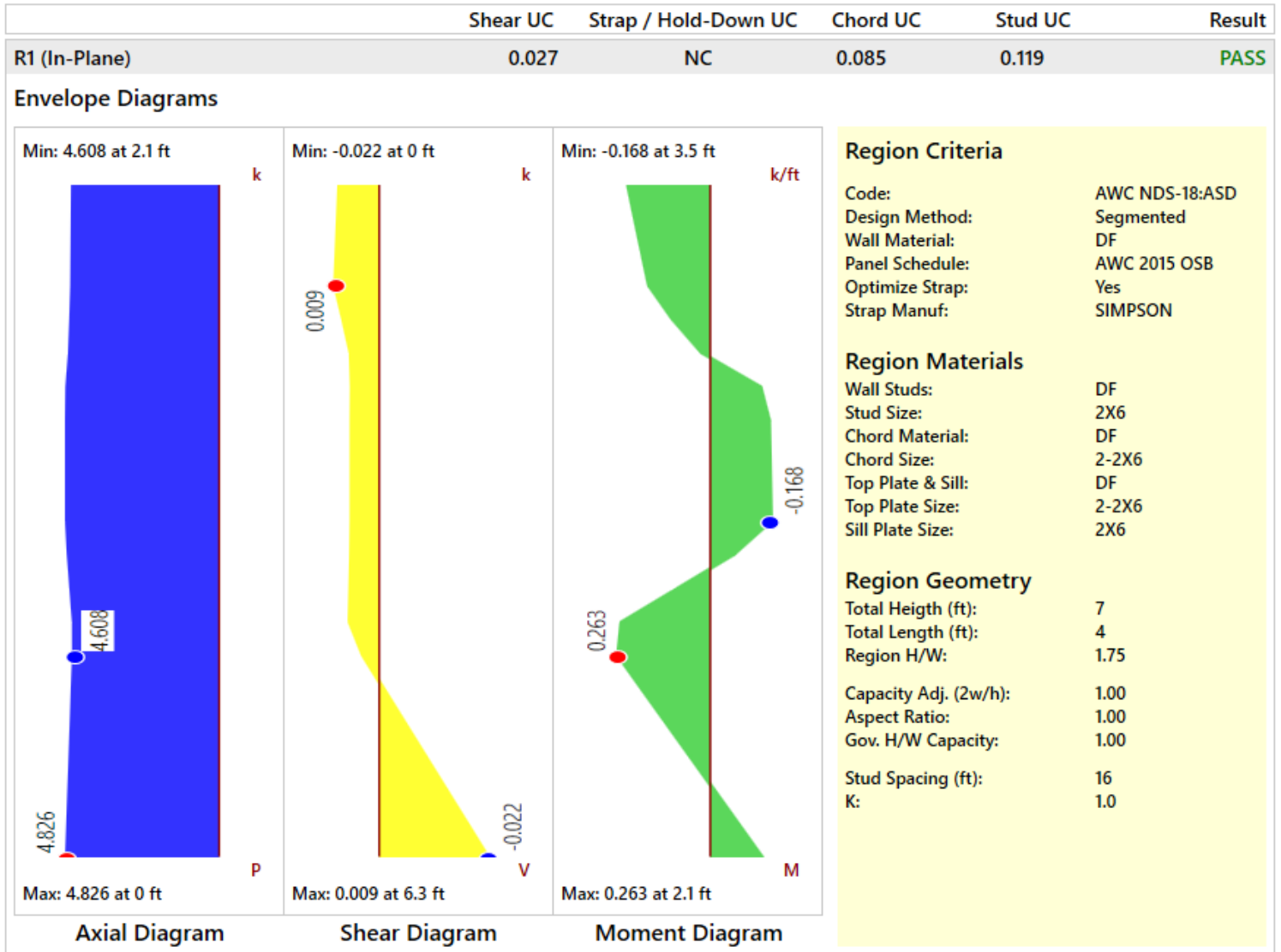
Envelope Diagrams

These diagrams show the axial forces, in-plane shear, and in-plane moments of the wall, as well as the maximum and minimum forces and their locations.

Note:

- The diagrams are not actually enveloped.
 - The **Axial** diagram shown is the diagram from the governing load combination for *Stud* design.
 - The **Shear** diagram is the diagram from the governing load combination for *Shear Panel* design.
 - The **Moment** diagram is the diagram from the governing load combination for *Hold-Down* design.

Design Summary

This portion gives you the capacity and strength values at the section in the wall where the combined check is maximum, as well as the governing load combination. Much of this information is also reported in the **Wood Wall Panel Design** spreadsheets.

Shear Panel

The provided capacity of the shear panel is taken from the **Shear Capacity** column of the panel database. This is the allowable shear value from Table 2306.4.1 from the 2006 IBC (for NDS design) or Table 9.3A, 9.3B, and 9.3C from the CSA O86-14 (for Canadian design). This capacity automatically considers whether the loading is based on wind or seismic loads. The Governing LC explicitly states if the controlling load combination was based on Wind or Seismic. The program does a unity check for all LCs that are being solved, finds the maximum value and reports that information.

Note:

- A shear panel design will be chosen for the worst-case region in a segmented wall. That panel will then be used for all regions in that wall. The worst-case region is the one that has the highest Shear UC value.
- Because wind and seismic loading allows for different design capacities, the highest shear in the wall may not be the governing shear (if that highest shear was due to wind).

Chords, Studs

The provided capacities of these members are calculated using the standard provisions for tension/compression members. These members are assumed to be fully braced in the weak axis, and unbraced in the strong axis. For more information on the chord force calculations, see the [Wood Wall - Design](#) topic.

Note:

- For chord results, the tension/compression capacity is computed using the reduced cross-sectional properties caused by the hold-down bolt hole.

Hold-Downs

The provided capacity of the hold-down is taken from the **Allowable Tension** column of the hold-down database. This is information supplied by the manufacturer. Note that we are modifying the Cd value for the hold-down based on taking a ratio of the assumed Cd values from the database and the Cd called for in the [Load Combinations](#) spreadsheet.

Chord Straps

The provided capacity of the chord strap is taken from the **Allowable Tension** column of the chord strap database. This is information supplied by the manufacturer. Note that we are modifying the Cd value for the chord strap based on taking a ratio of the assumed Cd values from the database and the Cd called for in the [Load Combinations](#) spreadsheet.

Deflections

The deflection listed in the detail report is based on an approximation from the design code.:

NDS Design Deflection

Per the NDS 2015 *Special Design Provisions for Wind and Seismic*, Equation 4.3-1:

$$\delta_{sw} = \frac{8vh^3}{EAb} + \frac{vh}{1000G_a} + \frac{h\Delta_a}{b}$$

b = Shear wall length, ft

Δ_a = Total vertical elongation of wall anchorage system (including fastener slip, device elongation, rod elongation, etc.) at

the induced unit shear in the shear wall, in (This value is taken from the hold down database and scaled per the actual tension force; hence you multiply this value by the holddown ratio given in the output)

E = Modulus of elasticity of end posts (chords), psi

A = Area of end post (chord) cross-section, in²

G_a = Apparent shear wall shear stiffness from nail slip and panel shear deformation, kips/in. (taken from shear panel database)

h = Shear wall height, ft

v = Induced unit shear, lbs/ft

δ_{sw} = Total shear wall deflection determined by elastic analysis, in

The first term of the above equation determines the Bending Component of the deflection.

The second term of the above equation determines the Shear Component of the deflection.

The third term of the above equation determines the Hold-Down Elongation, which causes additional deflection.

Note

- This is the theoretical deflection of the wall. This may differ from the deflection of the wall as performed by finite element analysis within RISA. Therefore, this deflection value may not coincide with the reported deflection value in the deflections spreadsheets. For information on making the FEM deflections similar to the reported deflections from the NDS calculated deflections, see the [Shear Stiffness Adjustment Factor](#) information.
- For **Perforated** design deflections, the total deflection is to be divided by C_o per section 2305.3.8.2.9 of the IBC 2006. Because the unit shear values have already been amplified by C_o , the only portion of the deflection that needs to be divided is the hold-down portion.
- The hold-down deflection is reported for the maximum shear LC, which may not result in the largest hold-down component, but typically results in the highest total deflection.

CSA O86 Design Deflection

Per the CSA O86-14 clause 11.7.1.2 (or CSA O86-09 clause 9.7.1.1):

$$\Delta_{sw} := \frac{2 \cdot v \cdot H_s^3}{3 \cdot E \cdot A \cdot L_s} + \frac{v \cdot H_s}{B_v} + \frac{H_s}{L_s} \cdot d_a$$

Total vertical elongation of wall anchorage system (including fastener slip, device elongation, rod elongation, etc.)

d_a = at the induced unit shear in the shear wall, mm. (This value is taken from the hold down database and scaled per the actual tension force; hence you multiply this value by the hold down ratio given in the output)

E = Modulus of elasticity of boundary elements (chords), N/mm²

A = Area of end post (chord) cross-section, mm²

B_v = Shear through-thickness rigidity of the sheathing, N/mm (taken from shear panel database)

H_s = Shear wall segment height, mm

L_s = Shear wall segment length, mm

v = Induced unit shear, N/mm

Δ_{sw} = Total shear wall deflection determined by elastic analysis, mm

The first term of the above equation determines the Bending Component of the deflection.

The second term of the above equation determines the Shear Component of the deflection.

The third term of the above equation determines the Hold-Down Elongation, which causes additional deflection.

Note

- This is the theoretical deflection of the wall. This may differ from the deflection of the wall as performed by finite element analysis within RISA. Therefore, this deflection value may not coincide with the reported deflection value in the deflections spreadsheets. For information on making the FEM deflections similar to the reported deflections from the CSA calculated deflections, see the [Shear Stiffness Adjustment Factor](#) information.
- The hold-down deflection is reported for the maximum shear LC, which may not result in the largest hold-down component, but typically results in the highest total deflection.

Design Details**DESIGN DETAILS**

SELECTED SHEAR PANEL : **RS_3/8_8d@6**

Panel Grade	: RS	Nail Size	: 8d	Num Sides	: One
Panel Thick	: 0.375 in	Reqd Pen	: 1.250 in	Over Gyp Brd.	: No
		Reqd. Spacing	: 6 in	Shear Capacity	: 0.220 k/ft
				Adjusted Cap	: 0.154 k/ft

NOTE: NDS 2005 defines a 8d nail as being **2.5" x 0.1310" common, or**
2.5" x 0.113" galvanized box

SELECTED HOLD-DOWN : **HD2A_1.5_HF_F**

Raised	: No	Bolt Size	: 0.625 in	Reqd Chord Thk:	1.50 in
AB Diameter	: 0.625 in	Num Bolts	: 2	Reqd Chord Mat:	Hem Fir
				Base Capacity	: 0.992 k
				CD factor	: 1.6

The **Selected Shear Panel** gives the call-out from the shear panel database. The information below it is the information describing the call-out.

Note:

- There will also be an "Adjusted Shear Capacity" that takes the given shear capacity from the design code and divides it by any appropriate adjustment factors from the Geometry section at the top of the report.

The **Selected Hold-Down** gives the call-out from the hold-down database. The information below it is the information describing the call-out. The "Base Capacity" is the capacity from the manufacturer divided by the assumed Cd value from the database. The "CD factor" that is displayed is the value from the load combinations spreadsheet for the controlling load combination. The actual capacity of the hold-down is the Base Capacity*CD factor.

The **Selected Chord Strap** gives the call-out from the strap database. The information below it is the information describing the call-out. The "Base Capacity" is the capacity from the manufacturer divided by the assumed Cd value from the database. The "CD factor" that is displayed is the value from the load combinations spreadsheet for the controlling load combination. The actual capacity of the chord strap is the Base Capacity*CD factor.

The above section of the report echoes the database information for the selected shear panel and hold-down. For more information on these properties refer to [Appendix F-Wood Shear Wall Files](#).

Cross Section Detailing

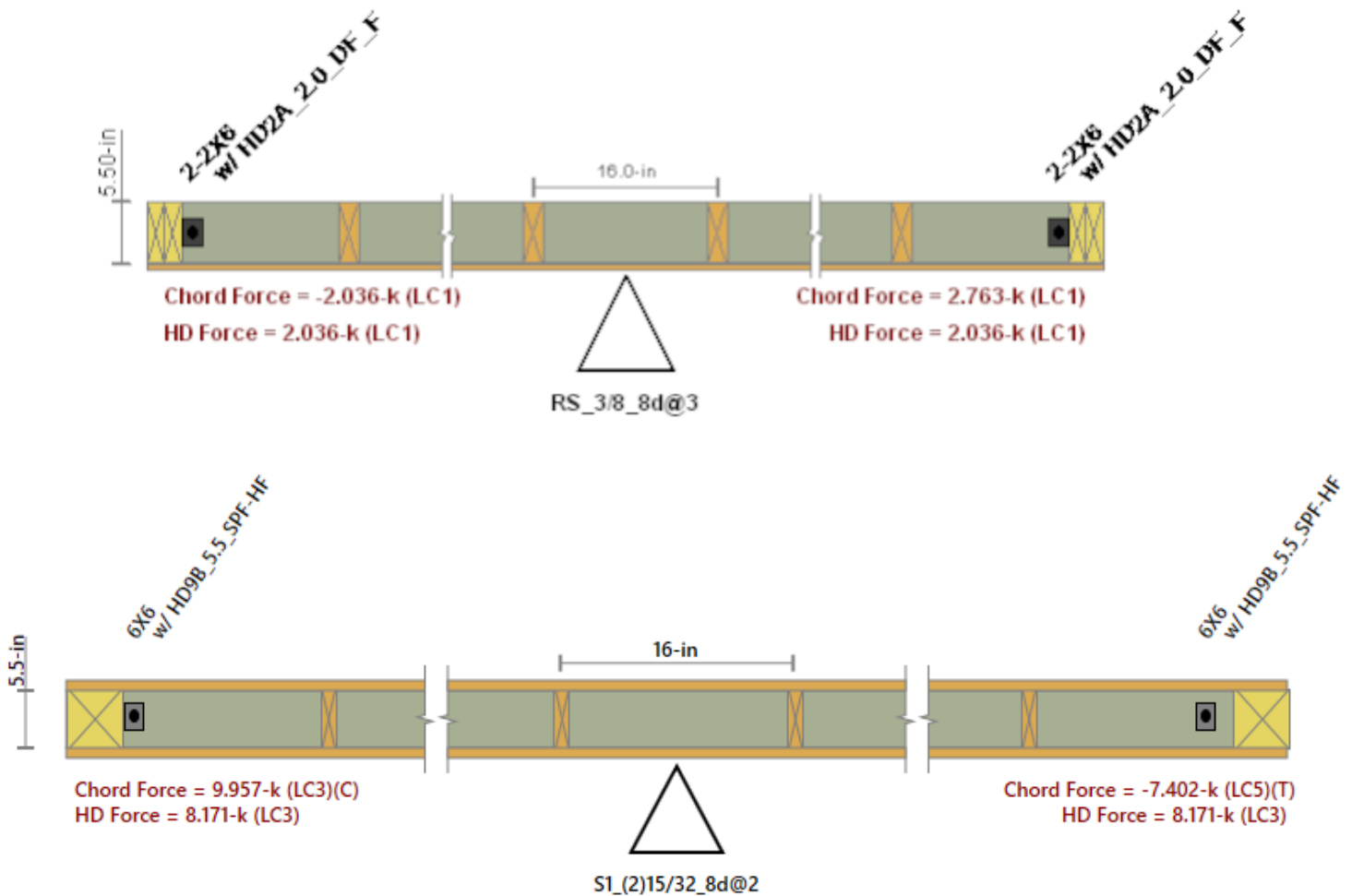

The last section of the detail report consists of the wall detailing information. This information is provided as a visual confirmation of the wall design. The wall thickness, and stud spacing are shown as dimensions. The triangle shows sheathing on one side of the wall, with the abbreviated panel designation. The chord sizes/forces and hold down or strap designations/forces are shown at either end. If either chord is only experiencing a compression force, the hold down or strap will not be drawn.

Note:

- The displayed chord force is not necessarily the force used in the hold-down design because hold-down optimization only considers the governing tension LC.

Perforated Method

Opening Window

This window is identical to the [Segmented Window](#) information.

Wall Window

This is where the majority of the information is located for the perforated method.

GENERAL

Code : AWC NDS-15:ASD
 Design Method : Perforated
 Wall Material : DF
 Panel Schedule : IBC06-09 Panel Data...
 Optimize HD : Yes
 HD Manufacturer: SIMPSON
 HD Eccentricity : 3 in

GEOMETRY

Total Height : 12 ft
 Total Length : 20 ft
 Wall H/W Ratio : 0.60
 K : 1.00
 Max Opening Ht : 4 ft
 Open/Wall Ht Ratio : 0.33
 Full Ht Sheathed : 14 ft
 % Full Ht Sheathed : 70.00

MATERIALS

Description	Material	Size
Top Pl	DF	2-2X6
Sill	DF	2X6
Wall Stud	DF	2X6
Chord	DF	2-2X6

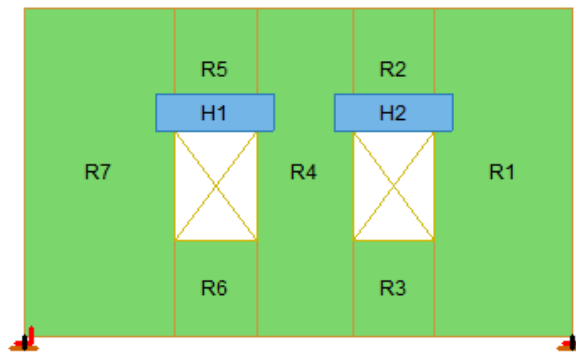

The **General** information gives some of the important parameters in designing the wall.

The **Geometry** section gives dimensions and ratios for the wall panel.

- The Wall H/W Ratio is checked against the aspect ratio limits given in Table 4.3.4 of the NDS 2015 *Special Design Provisions for Wind & Seismic* (SDPWS).
- The Max Opening Ht is used in the calculation of C_o .
- The % Full Ht Sheathed is used in the calculation of C_o .
- The Full Ht Sheathed is the Sum Li value for C_o .

The **Materials** information just gives the sizes of the members that are not explicitly talked about in the detail report.

Note:

- The top plate, sill plate and trimmer sizes are used only for the Material Take Off.

DESIGN DETAILS

Shear Stiffness Adjustment Factor	: 1.00	Shear Capacity Adjustment Factor (Co)	: 0.88
Wall Capacity Adjustment Factor (2w/h)	: 0.83	Total Area of Openings (Ao)	: 24.75 ft²
		Sheathing Area Ratio (r)	: 0.78

WALL DEFLECTIONS

Elastic:	: .017 in
HD:	: .126 in
Shear:	: .116 in
Total:	: .259 in

WALL RESULTS:

Governing LC	: 14 (Seismic)
Total Shear	: 3.889 k
Max Unit Shear	: .511 k/ft
Shear Ratio	: .995

SELECTED SHEAR PANEL : RS_(2)15/32_10d@6

Panel Grade	: RS	Nail Size	: 10d	Num Sides	: Two
Panel Thick	: 0.469in	Reqd Pen	: 1.250in	Over Gyp Brd.	: No
		Reqd. Spacing	: 6 in	Shear Capacity	: 0.620 k/ft
				Adjusted Cap	: 0.514 k/ft

NOTE: NDS 2005 defines a 10d nail as being: **3.0" x 0.1480" common, or**
3.0" x 0.122" galvanized box

SELECTED HOLD-DOWN :

Raised	: No	HD8A_3.5_HF_F		Reqd Chord Thk:	: 3.50 in
AB Diameter	: 0.875in	Bolt Size	: 0.875in	Reqd Chord Mat:	: Hem Fir
		Num Bolts	: 3	Base Capacity	: 4.774 k
				CD factor	: 1.6

CHORDS

Max Comp Force:	: 14.024 k
Comp Capacity	: 14.055 k
Comp Ratio	: .998
Gov Comp LC	: 22
Max Tens Force	: 7.467 k
Tens Capacity	: 19.217 k
Tens Ratio	: .389
Gov Tens LC	: 46

STUDS

Required Cap	: 3.418 k
Provided Cap	: 7.62 k
Ratio	: .449
Governing LC	: 2
Gov Region	: 1
Spacing	: 16 in

HOLD-DOWNS

Required Cap	: 7.467 k
Provided Cap	: 7.639 k
Ratio	: .978
Governing LC	: 46

The **Design Details** section gives adjustment factors and some other values used to calculate C_o . See the Wall Panels topic for more information on the [Shear Stiffness Adjustment Factor](#). See the [Wood Wall - Design](#) topic for more information on C_o .

The **Deflections** section gives the calculated deflection for the three term shear wall equation from the NDS. See [above](#) for more information on deflections.

The **Wall Results** section gives:

- The **Governing LC** is the load combination that produced the highest allowable code check. This will also state if this load combination was a wind or seismic LC.
- The **Total Shear** is the total shear in the wall for the governing LC.
- The **Max. Unit Shear** is the maximum shear in the shear panel and it is what is used to optimize the sheathing/nailing selection from the [shear panel database](#). Note that the Max Unit Shear may not be the absolute maximum, because shear walls governed by wind are allowed a 40% stress increase. Thus, a wind Max Unit Shear would need to be 40% higher than a seismic Max Unit Shear to govern.
- The **Shear Ratio** is a ratio of the Max Unit Shear over the Shear Capacity of the shear panel selected from the database.

The **Selected Shear Panel**, **Selected Hold-Down**, and **Selected Strap** section gives the same hold down, strap, and shear panel information that was given in the [Segmented region report](#).

There is then the chord, stud, hold-down, and strap design section that has the same information as given in the [Segmented region report](#).

The **Cross Section Detailing** section gives a detailed view of the wall. For more information see the [Segmented](#) section.

Force Transfer Around Openings (FTAO)

Wall Window

This is the overall wall information and is essentially identical to the [Perforated method](#) wall window information. There is some geometry information that is not necessary for FTAO that is omitted.

Opening Window

CRITERIA

Code : **NDS 2001: ASD**
Wall Type : **FTAO**

GEOMETRY

Opening Height : **3.5** ft
Opening Width : **9** ft
h/w ratio : **.389**

MATERIALS

Description	Material	Size
Header	DF Larch	6x8
Sill	DF Larch	2X6
Trimmer	DF Larch	6x6

ENVELOPE DIAGRAMS (Header)

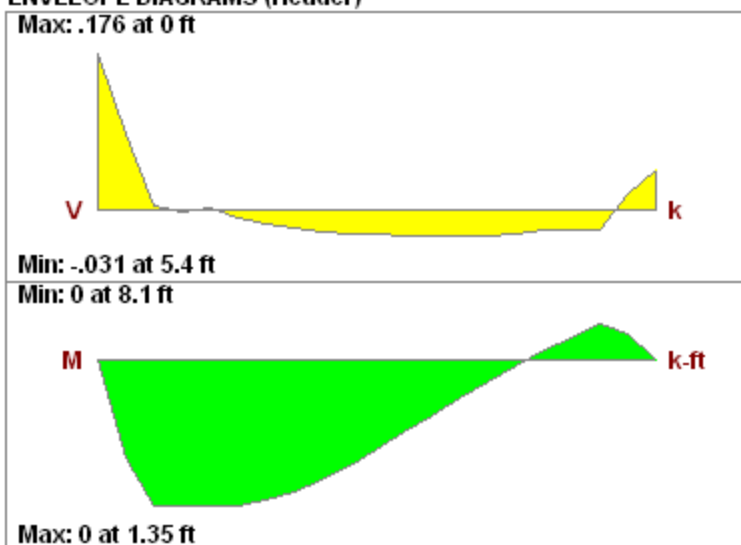

FTAO

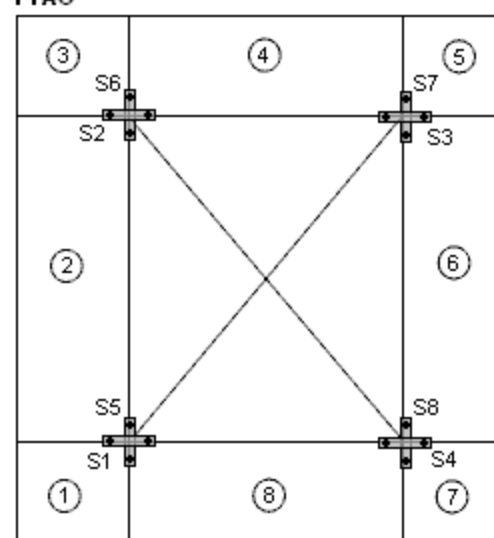

The **Criteria** section gives the code being used and which design method used.

The **Geometry** section gives the opening dimensions and the h/w ratio.

The **Materials** section gives dimensions for some of the members in the wall.

The **Envelope Diagrams** give the enveloped shear and moment diagrams for the header beam above the opening.

The **FTAO** graphic shows the design block numbers around the wall panel opening along with the strap numbers.

DESIGN DETAILS**OPENING STRAPS**

Name	Location	Direction	Req'd Cap (k)	Gov LC
S1	Bottom, Left	Horizontal	-0.7	1
S2	Upper, Left	Horizontal	0.3	1
S3	Upper, Right	Horizontal	-1.7	1
S4	Bottom, Right	Horizontal	0.9	1
S5	Bottom, Left	Vertical	-0.1	1
S6	Upper, Left	Vertical	-0.0	1
S7	Upper, Right	Vertical	-0.2	1
S8	Bottom, Right	Vertical	0.1	1

ANALYSIS SUMMARY

Block #	Unit Shear (k/ft)	h/w Ratio
1	-0.111	0.917
2	-0.206	0.583
3	-0.156	0.500
4	-0.292	0.333
5	-0.317	0.600
6	-0.190	0.700
7	-0.058	1.100
8	-0.174	0.611

The **Design Details** section is split into two different tables: Opening Straps and Analysis Summary. The opening straps information gives the location, direction, force in the strap and the load combination that caused that force.

Note:

- For more information on how the strap forces and unit shears are calculated, see the [Wood Wall - Design](#) topic.
- The program does not design the straps around the opening, just presents the forces.

The analysis summary gives the unit shear and the h/w ratio for each of the blocks.

The information below is the code check information for the header member. This is identical to the information given for [Segmented Window](#) information.

Warning Log

	Help	Message
1		Floor 3 : Floor Plan 3 - Lateral Member M2 Supported by Gravity Wall WP4.
2		Floor 3 : Floor Plan 3 - Lateral Member M3 Supported by Gravity Wall WP4.
3		Floor 2 : Floor Plan 2 - Lateral Member M2 Supported by Gravity Wall WP4.
4		Floor 2 : Floor Plan 2 - Lateral Member M3 Supported by Gravity Wall WP4.
5		Floor 1 : Floor Plan 1 - Lateral Member M2 Supported by Gravity Wall WP4.
6		Floor 1 : Floor Plan 1 - Lateral Member M3 Supported by Gravity Wall WP4.
7		Floor 1 : Floor Plan 1 - Deck - Concrete Deck : No composite design because deck selected is non-composite deck.
8		Concrete : Strength level code selected but no Strength level load combinations were solved for this material.

The **Warning Log Spreadsheet** provides you with a record of any warnings or errors that occurred during the solution of your model. The log should be reviewed for warnings or errors that would affect the design of your structure. The error log reports back the item label for which the error occurred.

You can view the warning log by clicking on the Spreadsheets menu item and then clicking on the Warning Log selection.

Pressing the ? hyperlink will open the help file to give further explanation on this item.

Here is a common warning which could require some additional explanation:

Sum of reactions is not equal to the sum of the loads (LC xx)! Check for any small rigid links or fixed boundary conditions.



When the solution is complete, the program checks the sum of the reaction forces in each direction if this is more than 0.1% different from the sum of the applied loads, then this warning message will be displayed. The most common causes for this warning message are the following:

- A joint instability which has been automatically LOCKED by the program. If the joint is locked then the reaction at that location is not computed. Once you rectify the instability then this warning log message should also go away. You may also need to uncheck the "[Lock isolated ROTATIONAL instabilities without notification](#)" box as this may conceal some instabilities. See the [Stability](#) section for more information.
- A user assigned boundary condition which was used the "Fixed, reaction will not be calculated" option rather than the "Reaction" option. See the [Boundary Conditions](#) section for more information. Using the term "Fixed" suppresses the reaction output in the Joint Reactions and thus the applied loads does not equal joint reactions. In this case the Warning Log could likely be ignored, as there is a valid reason for this discrepancy.
- A "ghost reaction" may have developed where one or more rigid elements (Diaphragms, rigid end offsets, or rigid links) have become so stiff that they actually became stiffer than the internal stiffness used by the program to define boundary conditions. In this rare case forces may be leaving the model at locations other than boundary conditions. Having a combination of a rigid diaphragm, rigid links, rigid end offsets, top of member offsets, etc., all in a localized place in the model could cause these.

For additional advice on this topic, please see the RISA Tips & Tricks webpage at risa.com/post/support. Type in Search keywords: **Sum of Reactions**.

*Please refer to the **Help File** in RISA-2D for detailed information about each error message. The Help File may be accessed by selecting **Help Topics** from the **Help Menu**. Choose the **Warning Log** topic*

Wood - Database

The Wood Database may be accessed from the **Wood** tab of the **Section Sets** spreadsheet by clicking in the **Shape** field and then clicking , or by clicking the **Shape Database** button  on the **RISA** toolbar and then clicking the **Wood** tab of the **Shape Database** dialog.

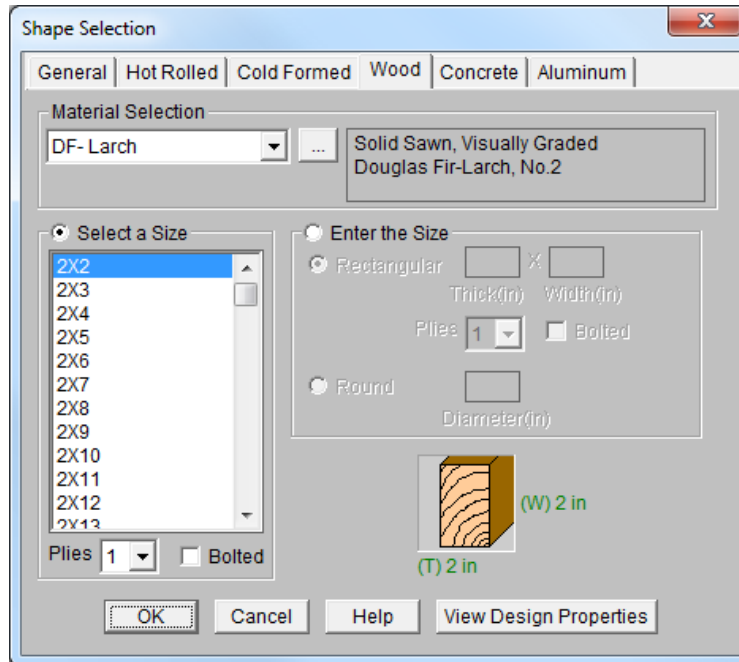

Wood Material/Shape Selection

Unlike any other material, the design properties for wood members depends both on the material selection as well as the shape selection. Therefore, the **Wood** tab of the **Shape Selection** database contains shape and material selections.

Material Selection

The **Material Selection** menu reads in material options that are currently listed on the **Wood** tab of your [Materials](#) spreadsheet. You may select one of these existing materials, or click on the **Add Material** button to open the **Create Wood Material** dialog which will allow you to add in a new material without having to go to the **Materials** spreadsheet.

Create Wood Material dialog

The **Create Wood Material** dialog allows you to create or edit a material that will then be automatically added to your [Materials](#) spreadsheet. This allows you to enter/select this information directly from the **Draw Members** dialog without having to first manually enter the information in the **Materials** spreadsheet.

- Click on the **Select Existing Material** button to select a material using the drop down menus to select a solid sawn, glulam, SCL, or already created custom material from the material databases.
- Click on the **Create a Custom Material** button to manually enter the design values for a new custom wood material. This information will then be automatically saved to the [Custom Wood Species](#) spreadsheet.

Size Selection

Currently there are two ways to define a member size, **Select a Size** menu or by using the **Enter the Size** option (typically referred to as Full Sawn).

- The **Select a Size** menus a list of nominal sized shapes for the NDS design code and a list of net sized shapes for the CSA O86 design code. When the NDS design code is chosen, the program will automatically reduce the shape properties to their net sizes. If the CSA O86 design code is selected, a list of *actual* metric sizes will be shown.
- The **Enter the Size** option will allow you to manually enter any *dressed* size that you like.
 - *Rectangular imperial* full sawn (as opposed to nominal dimensions) shapes will be designated with a "FS" suffix. You may also use this nomenclature to type the size directly into the spreadsheet. For example, a 7.25"x12" net rectangular member can be typed in as "7.25x12FS".
 - *Rectangular metric* full sawn (as opposed to nominal dimensions) rectangular shapes will be designated with a "MFS" suffix. You may also use this nomenclature to type the size directly into the spreadsheet. For example, a 184mmx305mm net rectangular member can be typed in as "184x305MFS".
 - *Round imperial* shapes will be designated with a "RND" suffix. You may also use this nomenclature to type the size directly into the spreadsheet. For example, a 10" net round member can be typed as "10RND".

- *Round metric* shapes will be designated with a "MRND" suffix. You may also use this nomenclature to type the size directly into the spreadsheet. For example, a 254mm net round member can be typed as "254MRND".

Note

- Multiple-ply lumber is assumed to be fastened sufficiently to achieve full composite behavior between plies. Therefore a two-ply member will have eight times greater minor-axis flexural stiffness than a single ply member (as opposed to double the stiffness).
- If using multiple plies there is a **Bolted** check-box. If this box is unchecked it is assumed that the plies are nailed together. If bolted is checked then it is assumed the plies are bolted together. This affects the Kf value from section 15.3.2 of the NDS 2005/2008, 2012, 2015, and 2018. If you define the multi-ply section as bolted a "B" (or "MB" for metric sizes) will appear after the shape name.

View Design Properties

Once you have selected the appropriate member size and material, you can click on the **View Design** properties button to view the un-adjusted wood design values (Fb, Fv, Ft, etc.) for the selected combination. The final adjusted values (Fb', Fv', Ft', etc.) will then be displayed after solution in the [Member Detail Reports](#).

Wood Database Limitations:**Round Shapes**

Per section 3.7.3 of the NDS, the design of a round cross section shall be based on the design calculations for a square shape with the same cross-sectional area. Therefore the moment of inertia values will be calculated per the equivalent square shape, not the round cross section. However, the section modulus value, S is calculated per the actual round shape.

Glulam Databases

The program includes five tables of available glulam materials: NDS Tables 5A - 5D and CSA O86 Table 6.3. The values in NDS tables 5B & 5D depend on the number of laminations in the glulam. Therefore you will see three listings (2 Laminations, 3 Laminations, or 4 Laminations) for each material. If you have a custom material that is not available from these lists, you can always enter your appropriate design values as a [Custom Wood Material](#) for use in your model.

Note:

- The design values used per NDS tables 5B & 5D take into account footnote #1 to reduce the reference shear design value Fvy depending on the number of laminations.
- None of the other footnotes in either of these tables is taken into account.

Mechanically Graded Lumber

Mechanically graded lumber grades (MSR & MEL) are available for use with the *ANSI/AWC NDS-2015* and the *CSA O86-2014* design codes. Older versions of the design codes will not support design of mechanically graded materials from the program databases. However, you can always enter the properties as a Custom Wood Material to get the design calculations for these materials in older code versions.

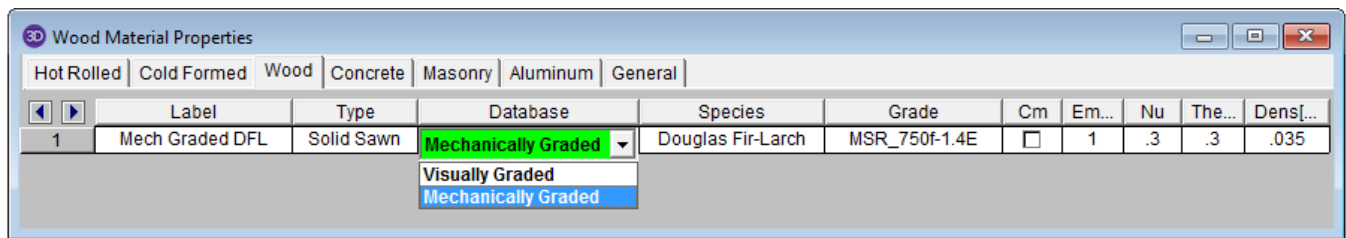

In order to assign a mechanically graded lumber material, you must select both the species and then the mechanical (MEL or MSR) grade. The species selection determines the shear capacity and compression perpendicular to grain capacity design values.

See *Footnote #2* from *NDS 2015 Table 4C* which says that all species from *NDS 2015 Table 4A* are applicable. See *clause 6.3.2* from *CSA 086-14* which says that specified shear strengths shall be taken from *CSA 086 Table 6.3.1A*.

The other design values are defined per the mechanical grade. See *NDS 2015 Table 4C* and *CSA 086-14 Tables 6.3.2 and 6.3.3*.

Structural Composite Lumber (SCL)

Each SCL manufacturer has documentation of their proprietary material design values. Because these are updated so often, RISA-3D relies instead on the design data from approved product reports (APA and ICC-ES) to build the material databases:

Manufacturer	Product Report	Notes
Ainsworth Engineered Wood*	APA PR-L260	*In 2015, Ainsworth Engineered was merged with Norbord Inc.
APA PRL-501	APA PR-L501	-
Boise Cascade	ICC-ES ESR-1040	-
Georgia Pacific**	APA PR-272	** Georgia Pacific sold to Boise Cascade in 2016
	APA PR-L257	
	APA PR-L266	
Global LVL	APA PR-L301	-
Louisiana Pacific	APA PR-L280	-
Murphy Engineered Wood	APA PR-L283	-
Pacific Woodtech	APA PR-L233	-
Roseburg Forest Products	APA PR-L289	-
	APA PR-L270	-
TrusJoist	ICC-ES ESR-1387	-

Footnote Limitations:

Each of the above reports includes tables with design values which were used to create the RISA-3D and RISAFloor SCL design property material databases. However, due to the difficulty of design variation, the following limitations are present:

- The F_b design values are not factored in accordance with the depth of the member. Currently RISA-3D always uses the single tabular F_b value regardless of member size.
- The F_t design values are not factored in accordance with the length or thickness of the member. Currently RISA-3D always uses the single tabular F_t value regardless of member size.
- The F_b design value will be increased by 4% if the member is designated as a repetitive member using the C_r check-box on the Wood tab of the Members spreadsheet.

Alternatively, you can always enter the appropriate design values, per the applicable footnotes, as a [Custom Wood Material](#).

Design Values

The design properties may be verified by clicking on the View Design Properties button on the Properties tab of the Member Information dialogs.

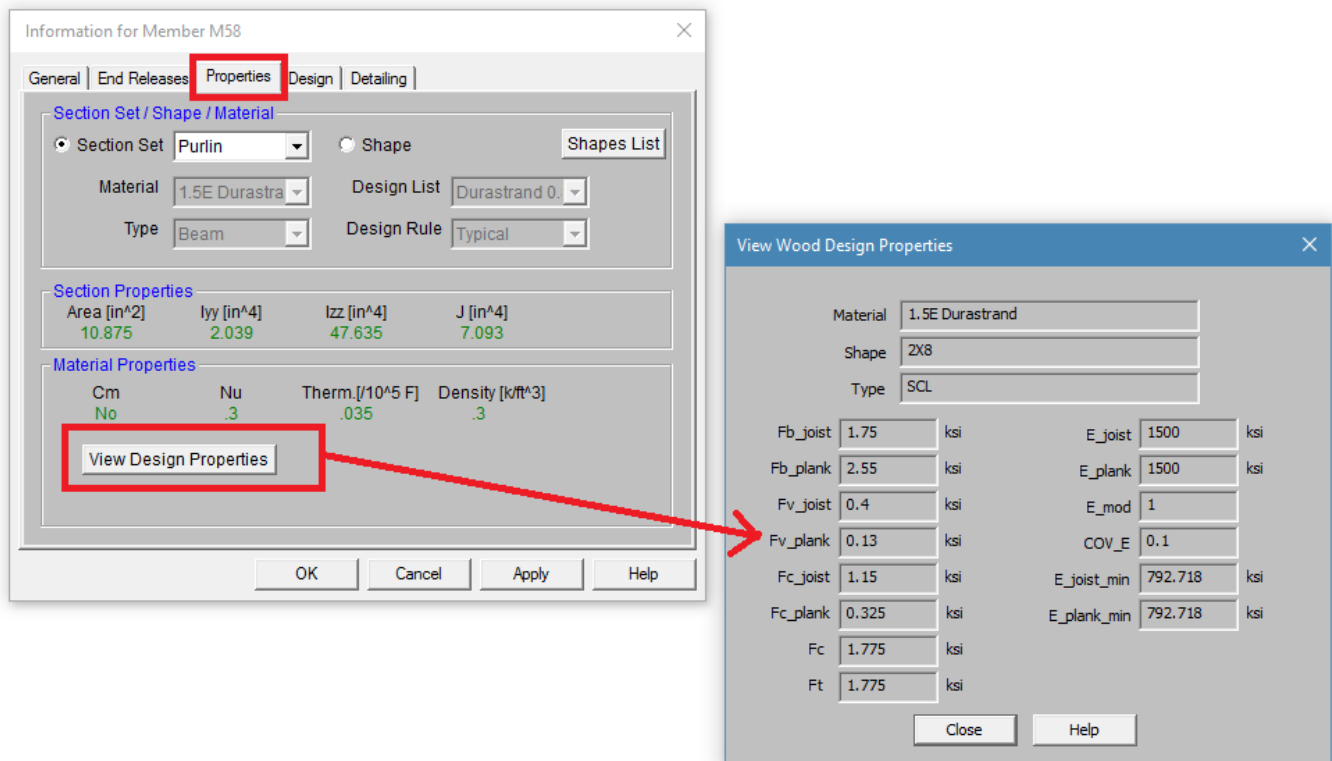

The values are as follows:

- **Fb_joist:** Bending capacity due to joist/beam edge loading
- **Fb_plank:** Bending capacity due to plank/flat edge loading
- **Fv_joist:** Shear capacity due to joist/beam edge loading
- **Fv_plank:** Shear capacity due to plank/flat edge loading
- **Fc_joist:** Compressive (perpendicular to grain) axial capacity due to joist/beam edge loading
- **Fc_plank:** Compressive (perpendicular to grain) axial capacity due to plank/flat edge loading
- **Fc:** Compressive (parallel to grain) axial capacity, regardless of load direction
- **Ft:** Tensile axial capacity, regardless of load direction
- **E_joist:** Modulus of elasticity due to joist/beam edge loading
- **E_plank:** Modulus of elasticity due to plank/flat edge loading
- **E_mod:** Young's Modulus modifier (always set as 1.0)
- **COV_E:** Coefficient of Variation in Modulus of Elasticity per NDS Table F1. This value is used in the Emin calculation. For SCL materials COV_E always equals 0.10.
- **E_joist_min:** Emin (as calculated per NDS Appendix D equation D-4) due to joist/beam loading
- **E_plank_min:** Emin (as calculated per NDS Appendix D equation D-4) due to plank/flat edge loading

Currently the program only designs using the *Joist* properties of the SCL materials. This assumes that the loading is always on the small dimension side of the member. In a future version we will be taking the Plank values into consideration as well. In the meantime you can always enter the appropriate design values from these tables as a [Custom Wood Material](#) for use in your model.

Note:

- Canadian wood member design only includes SCL design for the CSA 086-14 code.

Custom Wood Sizes:

If you would like to enter explicit dimensions of a member or if the member is "Not Dressed", the member must be designated as a "Full Sawn" member by checking the **Use Full Sawn Size** check box and entering the exact dimensions of the member in the boxes below. This applies to regular wood species, custom wood species, Structural Composite Lumber (SCL), and Glu-Lam members. The member thickness should be entered in the box on the left and the member width should be entered in the box on the right.

Wood - Design

Full code checking can be performed on Dimension Lumber and Post and Timber size wood shapes based on the following codes:

- The 2018 edition of the NDS
- The 2015 edition of the NDS
- The 2012 edition of the NDS
- The 2005/08 edition of the NDS
- The 2001 edition of the NDS
- The 1991 / 1997 editions of the NDS
- The 2014 edition of the CSA O86 Canadian wood design code
- The 2009 edition of the CSA O86 Canadian wood design code

Note

- When the 1991 / 1997 NDS is selected, the 1991 NDS specification will be used with the 1997 stress tables. This is consistent with the requirements of the 1997 UBC.

Glu-Lams

Glu-Lams are treated as any other wood species and may be selected from the list of species on the **Wood** tab of the **Materials** spreadsheet.

Glulam Material Properties

Available Glulam Materials are per Tables 5A and 5C of the NDS Supplement and Table 6.3 of the CSA O86. When a Glu-Lam is selected, the grade will be listed as "na" or not applicable.

If you prefer to use a material that is not listed in the design code glulam tables, please enter the material type as a [Custom Wood Species](#).

Note

- Glu-Lams from Table 5A are always assumed to have the special tension laminations. Therefore, the F_{bx} value is not reduced.
- RISA is NOT applying any of the footnotes to Table 5A and 5C at this time except for the following:
 - Footnote #1 from Table 5A - For balanced materials F_{bx-} shall equal F_{bx+} for the stress class.
 - Footnote #3 from Table 5A - F_{vx} and F_{vy} are increased for Southern Pine Glulam materials.
- Commentary to CSA O86 Clause 6.2 notes that the Hem Fir glulam species listed in Table 6.3 are not common and therefore they are not included by default in RISA. If you prefer to use one of these materials, please enter it as a Custom Wood Species.

Glulam Dimensions

All Glu-Lam members should be dimensioned as "Full Sawn" using the format $wXdFS$ (or $wXdMFS$ for metric sizes), where "w" and "d" are the actual width and depth dimensions. If the size is entered as wXd without the *FS* designation, then the size will be assumed to be regular dimensional lumber.

Glulam Redesign Lists/ Optimization

RISA includes two redesign lists for Glu-Lams: Glu-Lam_Western for Western Species and Hardwoods (HW), and Glu-Lam_SouthernPine for Southern Pine (SP/SP).

Glulam Limitations

Please note that glulam design is not supported for the 91/97 NDS design code.

Custom Wood Materials

To use a custom wood material that is not part of the standard NDS or CSA O86 databases, you will need to define the custom design properties. This can be done through the **Custom Wood Species** spreadsheet or directly through the **Materials** spreadsheet.

Custom Wood Properties Spreadsheet

To access the **Custom Wood Properties** spreadsheet, select **Custom Wood Species** from the **Spreadsheets** menu.

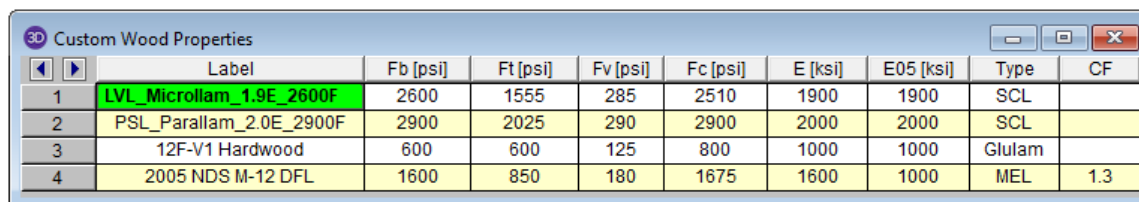

	Label	Fb [psi]	Ft [psi]	Fv [psi]	Fc [psi]	E [ksi]	E05 [ksi]	Type	CF
1	LVL_Microlam_1.9E_2600F	2600	1555	285	2510	1900	1900	SCL	
2	PSL_Parallam_2.0E_2900F	2900	2025	290	2900	2000	2000	SCL	
3	12F-V1 Hardwood	600	600	125	800	1000	1000	Glulam	
4	2005 NDS M-12 DFL	1600	850	180	1675	1600	1000	MEL	1.3

- **Fb** - Bending Stress Limit
- **Ft** - Tension Stress Limit
- **Fv** - Shear Stress Limit
- **Fc** - Compression (Parallel to Grain) Stress Limit
- **E** - Modulus of Elasticity
- **E05** - Fifth Percentile Modulus of Elasticity (for Canadian CSA O86 design only, ignored for NDS design)
- **Type** - Wood Type, used for determination of design variables (COV_E , E_{min} , c , etc.) and design calculations.
- **CF/KZ** - Wood Size Factor. The program will default this to 1.0 unless manually entered by the user.

Notes:

- Most wood materials (sawn lumber visually & mechanically graded, glulam, SCL, and LVL) are available in the current wood materials database. Please see the **Wood** tab of the [Materials spreadsheet](#) for more information.
- Due to the limited entries in the Custom Wood spreadsheet, Glulam members are always assumed to be balanced, uniform material:
 - Fb is taken as the Fbx+, Fbx-, and Fby values for glulam design.
 - Fv is taken as the Fvx and Fvy values for glulam design.
 - E is taken as the Ex and Ey values for glulam design.
 - Glulams will always use the CV volume factor equation per NDS Table 5C (this is the same equation as Tables 5A,5B, and 5D assuming that the material is not Southern Pine).

Create and Apply a Custom Wood Material

Create and apply your custom material by doing the following:

1. First, open the **Materials** spreadsheet to the **Wood** tab.
2. Select "**Custom**" as the material **Type**.
3. Click within the **Species** cell and then click on the red arrow. This will open the **Select Custom Material** dialog box.
4. Either select an **Existing Material** (this is read in from the **Custom Wood Properties** spreadsheet, see above), or **Create a Custom Material** by typing the properties directly into this dialog.

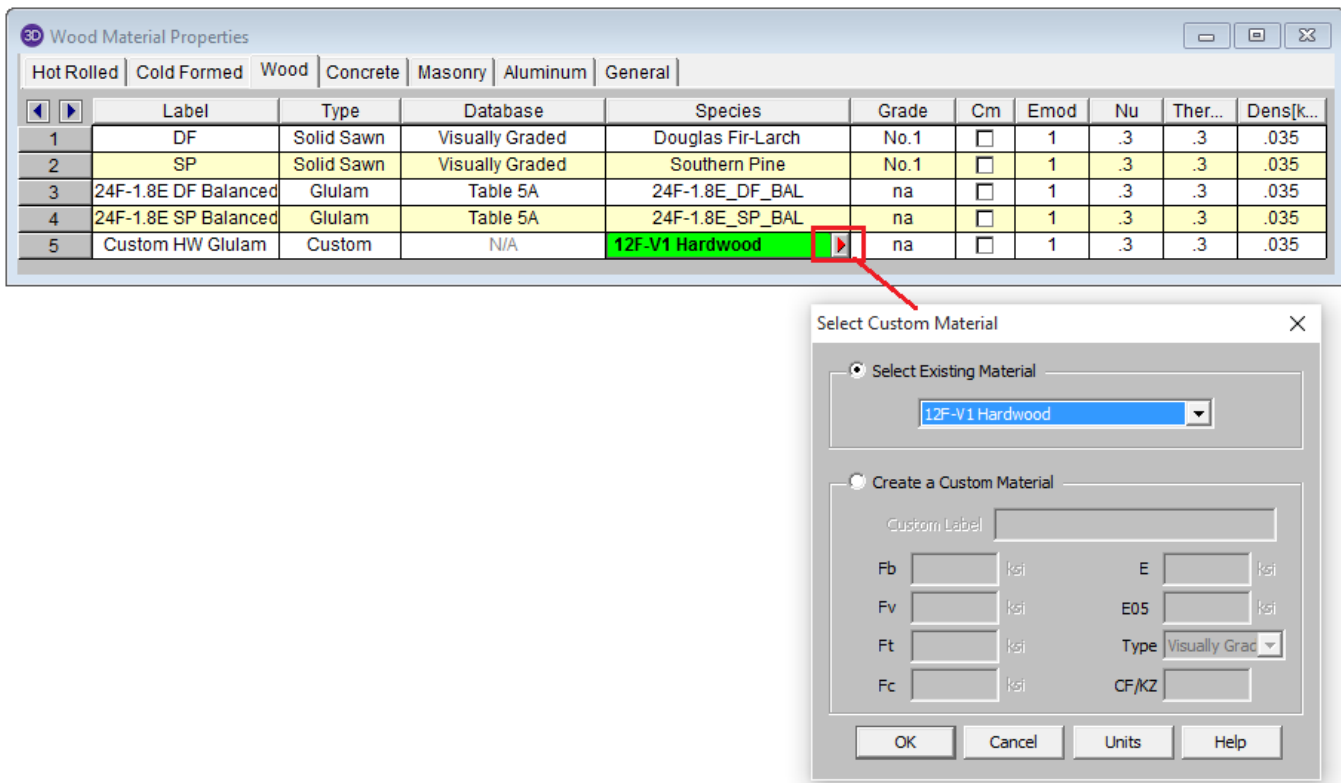

Note

- The **Type** menu is used to designate whether the entry is a **Visually Graded** sawn lumber, a **MSR** mechanically graded lumber, a **MEL** mechanically graded lumber, a **Glulam** material, or a **SCL** (structural composite lumber). This selection effects the design factors and the applicable provisions of the selected design code.

For additional advice on this topic, please see the RISA Tips & Tricks webpage at risa.com/post/support. Type in Search keywords: **Custom Wood Species**.

Wood Member Design Parameters

The **Member Design Parameters** spreadsheet records the design parameters for the timber code checks and may be accessed by selecting **Members** from the **Data Entry** toolbar and then clicking on the **Wood** tab. These parameters may also be assigned graphically. See to learn how to do this.

The image shows a window titled 'Wood Design Parameters' with tabs for 'Primary', 'Advanced', 'Hot Rolled', 'Cold Formed', 'Wood', 'Concrete Beam', 'Concrete Column', and 'Aluminum'. It contains a table with columns: Label, Shape, Length[in], Le-out[in], Le-in[in], le-bend top[in], le-bend bot[in], K-out, K-in, CV, Cr, Out sway, and In sway. The table has 6 rows. The 1st row, 'M1', is highlighted in green.

Label	Shape	Length[in]	Le-out[in]	Le-in[in]	le-bend top[in]	le-bend bot[in]	K-out	K-in	CV	Cr	Out sway	In sway
1	M1	COL1	96			Lb out				<input type="checkbox"/>	<input type="checkbox"/>	<input type="checkbox"/>
2	M2	COL2	96			48				<input type="checkbox"/>	<input type="checkbox"/>	<input type="checkbox"/>
3	M3	COL3	96	24	24	24				<input type="checkbox"/>	<input type="checkbox"/>	<input type="checkbox"/>
4	M4	BM1	120	60		60				<input type="checkbox"/>	<input type="checkbox"/>	<input type="checkbox"/>
5	M5	BM1	144	60		60				<input type="checkbox"/>	<input type="checkbox"/>	<input type="checkbox"/>
6	M6	BRC1	153.675			Lb out				<input type="checkbox"/>	<input type="checkbox"/>	<input type="checkbox"/>

These parameters are defined for each member.

Label

You may assign a unique **Label** to all of the members. Each label must be unique, so if you try to enter the same label more than once you will get an error message. You may relabel at any time with the **Relabel** options on

the **Tools** menu.

Shape

The member **Shape** or Section Set is reported in the second column. This value is listed for reference only and may not be edited as it is dictated by the entry in the **Section/Shape** column on the **Primary** tab.

Length

The member **Length** is reported in the third column. This value may not be edited as it is dependent on the member end coordinates listed on the **Primary Data** tab. It is listed here as a reference for unbraced lengths which are discussed in the next section.

Unbraced Length

See the [Unbraced Lengths](#) topic.

K Factors (Effective Length Factors)

See the [Unbraced Lengths](#) topic.

Adjustment Factors

Please see [below](#) for information about the various wood adjustment factors.

Sway Flags

See the [Unbraced Lengths](#) topic.

NDS Adjustment Factors

The NDS design codes have a number of adjustment factors that are applied to the various allowable stresses to determine the capacity of the member. The adjustment factors are summarized in section 2.3 of the code. The following topics help to summarize how adjustment factors are obtained and used.

Note

- C_b (Bearing Area Factor), C_T (Buckling Stiffness Factor), C_c (Curvature Factor), C_i (Stress Interaction Factor), and C_{vr} (Shear Reduction Factor) are NOT used in the RISA analysis.
- If you are using the Canadian CSA O86 design code, see the section below for the [CSA adjustment factors](#).

Timber Design CD (Load Duration Factor- NDS)

CD is the Load Duration adjustment factor used for ASD codes. It is entered on the [Load Combinations](#) spreadsheet for each load combination for which you want wood code check results. The CD factor must be entered for each individual load combination because the CD factor is dependent on the types of loads that are applied in each load combination. Therefore, different load combinations could have different CD factors. For example, per the NDS 2018 specification, a load combination that had only dead load, would have a CD factor of "0.9", while another combination that was comprised of dead load plus wind load would have a CD factor of "1.6".

The CD factor will only be applied to wood code checks on wood members. See Table 2.3.2 in the NDS 2018 specification for the CD factors to be applied for typical loads. Appendix B has additional information about the Load Duration Factor.

Note

- The CD factor used for a load combination should be for the load with the shortest load duration in that load combination.

Timber Design Cm (Wet Service Factor)

Cm is the Wet Service adjustment factor. It is applied when you check the **Cm** checkbox in the [Materials Spreadsheet](#).

Timber Design Ci (Incision Factor- NDS)

Ci is the Incision factor per Table 4.3.8 of NDS code. It is applied when you check the **Ci** checkbox in the [Materials Spreadsheet](#).

Timber Design Ct (Temperature Factor)

Ct is the Temperature adjustment factor. It is calculated internally based on the wood **Temperature** value set on the **Codes** tab of [Model Settings](#). See section 2.3.3 of the NDS 2018 for more information on this factor.

Timber Design CP and CL (Column/Beam Stability Factors - NDS)

The Column Stability Factor, **CP**, and the Beam Stability Factor, **CL**, are calculated internally. These calculated values are shown on the **Wood** tab of the **Code Check Spreadsheet**, as well as in the **Member Detail Reports**. See NDS 2018 section 3.3.3 for information on the CL factor and NDS 2018 section 3.7.1 for information on the CP factor.

The value of Emin used for the calculation of these factors is calculated using equation D-4 from appendix D of the 2018 NDS. For some members (especially for glulams) this equation may produce a slightly more accurate value of Emin that shown in the NDS tables.

Note

- The column stability factor, CP, is affected by the Kf factor from NDS 2018 section 15.3.2, depending on whether multi-ply members are bolted or nailed together. Bolted columns will have a shape name with a **B** after. See the [Wood-Database](#) topic for information on how to define bolted vs nailed multi-ply members.

Timber Design CF (Size Factor- NDS)

CF is the Size adjustment factor. It is applied automatically when you assign a wood shape from the NDS shape database. See Tables 4A, 4B, 4D, and 4E in the NDS supplement for information on the CF factor.

Note:

- Prior to the 2012 NDS, Table 4D (Reference Values for Timbers) combined the Size Factor(CF) and the Flat Use Factor (Cfu) under the Size Factor (CF) description. Per the code commentary, you are required to apply both the CF per the equation in Table 4D and the CF per the tabular values. To clarify between the two, the program calls the calculated value (per the equation) CF and the tabular value Cfu. This is verified with clarification in the NDS 2012 design code.

Timber Design CV (Volume Factor)

CV is the Volume adjustment factor. It is applied automatically when you assign a glulam or SCL material member. The user can override the calculated value by manually entering the factor on the **Wood** tab of the [Members Spreadsheet](#).

Note:

- In the calculation of CV, RISA takes L as the full length of the member. This is a conservative assumption.
- This factor is not available for the NDS 1991/1997 design option.

Timber Design Cfu (Flat Use Factor)

Cfu is the Flat Use adjustment factor. is automatically applied to the weak axis allowable bending stress of a wood member whenever weak axis moments are present. See the tables in the NDS supplement for more information on this factor.

Note

- Prior to the 2012 NDS, Table 4D (Reference Values for Timbers) combined the Size Factor(CF) and the Flat Use Factor (Cfu) under the Size Factor (CF) description. Per the code commentary, you are required to apply both the CF per the equation in Table 4D and the CF per the tabular values. To clarify between the two, the program calls the calculated value (per the equation) CF and the tabular value Cfu. This is verified with clarification in the NDS 2012 design code.

Timber Design Cr (Repetitive Factor)

Cr is the Repetitive Member adjustment factor. This factor specifies if the beam is one of a group of repetitive members. This design parameter can be set on the **Wood** tab of the [Members Spreadsheet](#). If you put a check in the Cr field, a factor of 1.15 will be applied to beam members that are 2" to 4" thick. See the section 4.3.9 of the NDS 2018 for information on this factor.

Note

- This flag will be ignored for a NDS shape that is thicker than 4".
- A value of '1.0' will be used for Wood Products.
- Different restrictions apply to the use of the Cr factor for Structural Composite Lumber and Glu-Lams.

Timber Design CH (Shear Stress Factor)

CH is the Shear Stress adjustment factor. This design parameter can be set on the **Wood** tab of the [Members Spreadsheet](#). If left blank the program will use a default value of 1.0. See the tables in the NDS supplement for information on other CH factors.

Note

- The CH factor is only available for the 1991/1997 NDS option. For other codes, this entry will be ignored.
- Only tables 4A, 4B, and 4D are used.

Timber Design Cf (Form Factor)

Cf is the Form adjustment factor. It is applied automatically when designing by the NDS 91/97 or 2001 Specification and a 'Round' shape is selected from the NDS shape database. See section 2.3.8 in the NDS (91/97, 2001) for information on the Cf factor.

Note

- This factor is not applied when designing with the NDS 2005 or 2012 specifications.
- This factor is not applied to "diamond" shaped members, which are just rectangular members on edge. This factor is not applied to diamond shapes because any applied moments are transformed internally to the local member axes for the code check calculations, which is the same as applying the "diamond" form factor and NOT transforming the moments.

Timber Design Kf (Format Conversation Factor)

Kf is the format conversion factor for LRFD design only. The tabulated reference design values provided in the NDS Supplement contain safety adjustments appropriate for ASD. The Kf factor converts these values to nominal design values for LRFD. These factors are provided in NDS Table 4.3.1 and Appendix N.

Timber Design Phi (Resistance Factor)

Phi is the resistance factor for LRFD design only. These values are provided in NDS Table 4.3.1 and are dependent on the property ranging from 0.75 for shear and 0.90 for compression.

Timber Design lambda (Time Effect Factor- NDS)

Lambda is the Time Effect adjustment factor used for LRFD codes. It is entered on the [Load Combinations](#) spreadsheet for each load combination for which you want wood code check results. The lambda factor must be entered for each individual load combination because the lambda factor is dependent on the combination of loads. Therefore, different load combinations could have different lambda factors. For example, per the NDS 2018 specification, a load combination that had only dead load, would have a CD factor of “0.6”, while another combination that was comprised of dead load plus wind load would have a CD factor of “1.0”.

The lambda factor will only be applied to wood code checks on wood members. See Table N3 in the NDS 2018 specification for the lambda factors to be applied for typical load combinations.

CSA O86 Adjustment Factors

The *CSA O86* design code has a number of adjustment factors that are applied to the various allowable stresses to determine the capacity of the member. The adjustment factors are summarized in clause 4.3 of the code. The following topics help to summarize how adjustment factors are obtained and used.

Note

- KB (Length of Bearing Factor), KE (End Fixity Factor), KF (Foundation Factor for plywood), KM (Bending Capacity Modification Factor), KN (Notch Factor), KR (Radial Stress Factor), KT (Treatment Factor), and KX (Curvature Factor) are NOT used in the RISA analysis.

Timber Design KD (Load Duration Factor - CSA)

KD is the Load Duration adjustment factor. It is entered on the [Load Combinations](#) spreadsheet for each load combination for which you want wood code check results. The KD factor must be entered for each individual load combination because the factor is dependent on the types of loads that are applied in each load combination. Therefore, different load combinations could have different KD factors. For example, per the CSA O86 -2009 specification, a load combination that had only dead load, would have a KD factor of 0.65, while another combination that was comprised of dead load plus wind load would have a KD factor of 1.15.

The KD factor will only be applied to wood code checks on wood members. See Table 5.3.2.2 in the CSA O86 - 2014 specification for the KD factors to be applied for typical loads.

Note

- The KD factor used for a load combination should be for the load with the shortest load duration in that load combination.

Timber Design Ks (Service Condition Factor)

Ks is the Service Condition adjustment factor. It is applied when you check the **Ks** check-box in the [Materials Spreadsheet](#). See clause 6.4.2 (sawn lumber) or clause 7.4.2 (glulams) in the CSA O86-14 for more information on this factor.

Timber Design CV (Shear Load Coefficient-CSA)

CV is the Shear Load coefficient for glulam members. It is applied automatically when you assign a material from the **CSA Table 7.3** glulam material database. By default this value will always be taken as 1.0. However, the user can override this value by manually entering the factor on the **Wood** tab of the [Members Spreadsheet](#).

Timber Design KH (System Factor)

KH is the System adjustment factor. This factor depends on the System Factor selection applied to the member on the **Wood** tab of the **Members** spreadsheet:

- **None** - Assumes that the member is NOT in a system of repetitive members and therefore $KH = 1.0$.
- **Sheathed** - Assumes that the member is in a system of repetitive members and the members are sheathed with plywood. This is defined as "Case 2" in clause 6.4.4.2 for sawn lumber. In this case KH will come from Table 6.4.4 (2014 code).
- **UnSheathed** - Assumes that the member is in a system of repetitive members but the members are NOT sheathed with plywood. This is defined as "Case 1" in clause 6.4.4.1 for sawn lumber. In this case KH will come from Table 6.4.4 (2014 code).

Note

- If the member is a glulam, selecting either "Sheathed" or "Unsheathed" will apply the KH factors per clause 7.4.3. If "None" is selected than KH will be taken as just 1.0.
- Always assumed 1.0 for wood wall design per the CSA O86 design codes.

Timber Design KZ (Size Factor- CSA)

KZ is the Size factor. It is applied automatically when you assign a wood shape from the CSA shape database. See Table 6.4.5 in the *CSA O86-14* design code for information on this factor.

Timber Design KL (Lateral Stability Factor - CSA)

KL is the Lateral Stability factor. This factor is calculated internally per the equation given in clause 7.5.6.4.4 for both glulam and full sawn members.

The final calculated values of both CB and KL are shown on the **Wood** tab of the **Code Check Spreadsheet**, as well as in the **Member Detail Reports**.

Note:

- Clause 6.5.4.2.1 allows full sawn members to use the glulam clause 7.5.6.4 to determine KL.

Timber Design KC (Slenderness Factor)

KC is the Slenderness factor. This factor is calculated internally per the equation given in clause 6.5.6.2.4 for full sawn members and per clause 7.5.8.5 for glulam members.

Note:

- The program will use the maximum C_c value (per clause 6.5.6.2.2 or 7.5.8.2) in the KC calculation.

Timber Design Flat Use Factor -CSA

The Flat Use factor is just called "**Flat Use**" in the member detail report. There is no explicit factor for this defined in the *CSA O86-14* design code. However, there is a note for Table 6.3.1C (*Material Strengths for Beams and Stringers*) that includes a flat use adjustment factor. The program will determine this factor based on the asterisk table under Table 6.3.1C.

Limitations - Wood Design

- It is assumed that the load on the member is occurring through the member's shear center. This means secondary torsional moments that may occur if the load is not applied through the shear center are not

considered.

- Currently the program only considers the Joist loaded edge design values for SCL members per NDS design.
- *CSA 086* wood design will not automatically account for the E_s value (per clause 5.4.1). If the user wants to account for this modified modulus of elasticity, then you must manually adjust the material properties.

Adjustment Factor Limitations

- **Buckling Stiffness Factor** - The NDS buckling stiffness factor, CT , is not currently accounted for.
- **Bearing Area Factor** - The NDS bearing area factor, C_b , is not currently accounted for.
- **Curvature Factor** - The NDS curvature factor for glulams, C_c , is not currently accounted for.
- **Stress Interaction Factor** - The NDS stress interaction factor for glulams, CI , is not currently accounted for.
- **Shear Reduction Factor** - The NDS shear reduction factor for glulams, C_{vr} , is not currently accounted for.
- **Length of Bearing Factor** - The CSA 086 length of bearing factor, KB , is not currently accounted for.
- **End Fixity Factor** - The CSA 086 end fixity factor, KE , is not currently accounted for.
- **Foundation Factor** - The CSA 086 foundation factor (for plywood), KF , is not currently accounted for.
- **Bending Capacity Modification Factor** - The CSA 086 bending capacity modification factor, KM , is not currently accounted for.
- **Notch Factor** - The CSA 086 notch factor, KN , is not currently accounted for.
- **Shear Load Coefficient** - The CSA 086 shear load coefficient for glulams, CV , will always default to 1.0. The user can override this by manually typing in the appropriate **CV** value on the **Wood** tab of the **Members** spreadsheet.
- **Radial Stress Factor** - The CSA 086 radial stress factor, KR , is not currently accounted for.
- **Treatment Factor** - The CSA 086 treatment factor, KT , is not currently accounted for.
- **Curvature Factor** - The CSA 086 curvature factor for glulams, KX , is not currently accounted for.

NDS Emin Calculation

RISA will calculate the E_{min} value for NDS wood materials rather than read it in from the design tables. In the 2018 edition of the NDS, E_{min} is calculated per equation (D-4) from Appendix D.

$$E_{min} = E * (1 - 1.645 * COV_E) * \left(\frac{1.03}{1.66} \right)$$

COV_E (the coefficient of variation in modulus of elasticity) comes from Table F1 in Appendix F.

Note

- If your member is a glulam or SCL material, the E_{min} equation becomes:

$$E_{min} = E * (1 - 1.645 * COV_E) * \left(\frac{1.05}{1.66} \right)$$

Wood Member Code Check Results

Access the **Wood Code Checks Spreadsheet** by selecting the **Results** menu and then selecting **Members** ▶ **Design Results** and then clicking the **Wood** tab.

LC	Member	Shape	UC Max	Loc (ft)	Shear UC	Loc (ft)	Fc (ksi)	Ft (ksi)	Fb (ksi)	Fv (ksi)	RB	CL	CP	Eqn
0	M33	2x4	.024	0	.000	0	535	2.4	3.6	.152	8.641	1	.171	3.9-1
8	M34	2x4	.068	0	.000	0	535	2.4	3.6	.152	8.641	1	.171	3.9-1
8	M35	2x4	- ft is grea											
8	M36	2x4	.068	0	.000	0	535	2.4	3.6	.152	8.641	1	.171	3.9-1
8	M37	2x4	.024	0	.000	0	535	2.4	3.6	.152	8.641	1	.171	3.9-1
8	M38	2x4	.001	0	.000	0	535	2.4	3.6	.152	8.641	1	.171	3.9-1
8	M39	2x4	.029	0	.000	0	535	2.4	3.6	.152	8.641	1	.171	3.9-1
8	M40	2x4	.077	0	.000	0	535	2.4	3.6	.152	8.641	1	.171	3.9-1

Code Checks

The final result of the design solution are the code check values (ratios of actual stress to allowable stress). So, if these values are less than 1.0, the member passes. If they are greater than 1.0, the member fails.

Note:

- If the value is greater than 9.999 it will be listed as "9.999".
- The [Member Detail Report](#) gives a more detailed view of the values used to perform the code check.
- See [Model Settings - Members](#) to learn how to view the code check results graphically.

The **UC Max** value represents the combined bending and axial force stresses. The governing equation that was used to calculate the UC Max value is listed at the far right of the spreadsheet in the **Eqn** column.

The **Shear Check** is the maximum ratio of actual to allowable shear stress.

The **Loc** fields that are to the right of the code check fields tells at what location the maximum code check occurs measured from the I-joint location of the member.

Capacity Values

The values (Fc', Ft', Fb, Fv') are the factored allowable stresses per NDS wood member design.

- **RB** is the adjustment factor described by Eqn. 3.3-5 of the 2018 NDS Specification. This is a slenderness ratio that is not allowed to exceed 50.
- **CL** is the [beam stability factor](#) calculated using Eqn. 3.3-6 of the NDS Specifications.
- **CP** is the [column stability factor](#) calculated using Eqn. 3.7-1 of the NDS Specifications.

The values (Pr, Tr, Mr, Vr/Wr) are the allowable forces per CSA 086 wood member design. These will only be visible when you have selected the **CSA 086-09: Ultimate** or **CSA 086-14: Ultimate** as your wood design code in [Model Settings](#).

Finally, the **Equation** controlling the code check is listed. For NDS wood member design, this will be either Eqn. 3.9-1 or 3.9-3. Eqn. 3.9-2 is not checked since this equation includes the tension stress in a beneficial (non-conservative) manner. All other requirements in Section 3.9 are also checked, such as $f_c < F_{cE1}$, etc. To see ALL the adjustment factors and other information used to calculate the factored allowable stresses, please go to a detail report for the member in question. You can do that from this spreadsheet by clicking [Detail Report for Current Member](#).

Notes

- For Enveloped results the combination that produced the listed code and shear checks is given in the "LC" column. The other values are the corresponding values and are not necessarily the maximums across all the combinations.
- Moving Load results are enveloped and the governing load combination and step location is shown for each result value under the "LC" column. The first number is the load combination, the second is the step number: (load combination - step number). See [Moving Loads](#) to learn more.

Special Messages - Wood Design

In some instances code checks are not performed for a particular member. A message explaining why a code check is not possible will be listed instead of the code check value. You may click the cell that contains the message and look to the status bar to view the full message. Following are the messages that may be listed:

Code Check Not Calculated

This is the general message displayed when code checks were not performed for a member. It could mean that you have not selected a Design Code in [Model Settings](#) or you have not included any load combinations for this material type in your solution. Check the **Design** tab of the **Load Combinations** spreadsheet.

RB value is greater than 50

Section 3.3.3.7 of the NDS code limits the slenderness ratio RB to a maximum of 50. Similarly, clause 7.5.6.4.3 of the CSA O86 limits CB to a maximum of 50. You will need to reduce the effective span length, increase the thickness of the shape, or reduce the depth of the shape.

le/d is greater than 50

Section 3.7.1.4 of the NDS code limits the column slenderness ratio of Le_1/b or Le_2/d to a maximum of 50. You need to reduce your effective length by reducing the actual length between supports or changing the effective length factor "K". You can also use a thicker shape.

fc is greater than FcE1

Section 3.9.2 of the NDS code limits the actual axial compressive stress to be less than the term $FcE1$. This term is approximately the Euler buckling stress for buckling about the strong axis of the member. (Buckling is in the plane of bending)

fc is greater than FcE2

Section 3.9.2 of the NDS code limits the actual axial compressive stress to be less than the term $FcE2$. This term is approximately the Euler buckling stress for buckling about the weak axis of the member. (Buckling is in the plane of bending)

fb1 is greater than FbE

Section 3.9.2 of the NDS code limits the actual strong axis bending compressive stress to be less than the term FbE . This term is approximately the lateral buckling stress.

Appendix A – Redesign Lists

RISA-2D has Redesign Lists that are used to optimize hot-rolled steel, cold-formed steel, dimensional lumber, and concrete beams and columns. Although, the criteria used for this optimization is the **Design Rules**, the sizes must be chosen from the available sizes in the Redesign List.

For additional advice on this topic, please see the RISA Tips & Tricks webpage at risa.com/post/support. Type in Search keywords: **Redesign**.

Design List Mismatch

If you see a Design List and Shape Database Mismatch dialog, then there is a mismatch between your default shape database and the design list you have currently selected. Either choose a Design List to match the default Shape Database, or change your default Shape Database so that you can use the Design List you want. To check your default Shape Database, open the Shape Database which is located on the Advanced tab of the ribbon toolbar. In the Shape Database, your default databases will currently be selected for each material.

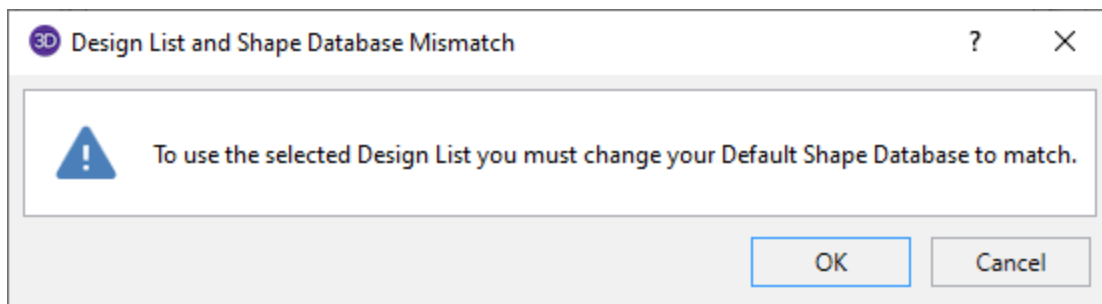

Locating the Design Lists

By default the redesign list files exist in the Redesign Lists folder in the user's Documents\RISA folder. However, this folder can be changed by selecting [Tools - Preference - File Locations](#) from the main menu toolbar.

File Naming Convention for the Design Lists

The design lists must be ASCII text files with a file extension of ASC. In addition, the first 3 characters of the Design indicate which Region the lists will be available for. The region can be changed by selecting [Tools - Prefereces - General](#) from the Main Menu Toolbar. Each region corresponds to the following file name prefix.

Region	File Prefix
United States	US_
Canada	CA_
Britain	BS_
Europe	EU_
India	IN_
Australia	AU_
New Zealand	AU_
Mexico / South America	MX_

File Format for Redesign Lists

The following is an example of a user defined redesign list. You may view these files using any text editor such as Window's Notepad. However, this file must be saved in the risa_redesign_lists folder as an ASCII text file with a file extension ASC. If the file is saved with a txt extension, it will not be read into RISA-2D. The various entries for the input fields are described below:

The first field [RISA_REDESIGN_LIST] identifies this as a RISA Redesign list. If this line is not present the file will not be recognized by the program.

The second field [NAME] identifies that the next entry will be the name of the Shape Group that will identify this list in the program. In this case, this Shape Group is given the name *Available W24s*.

The next field [MATERIAL_TYPE] identifies that the next entry will be the material type that this shape group belongs to. This material type must be given one of the following designations: Hot Rolled Steel, Cold Formed Steel, Wood, Steel Products, or Wood Products.

The next field [MEMBER_TYPE] identifies that the next entry will be the designation of the member type. This entry must be designated as either a Beam or Column.

The next field [ASSOCIATED DATABASE] identifies that the next entry will be the RISA database name in which the entered shapes are defined.

The next field [UNITS] identifies the units used to define the member sizes in the redesign list. Entries may be Inches, Millimeters, or Centimeters. This field is only applicable to files similar to the concrete and wood lists which have the dimensions built right into the list. For files which are based on database shape names, this field will have no effect.

The next field [END HEADER] identifies the end of the descriptive information and the beginning of the shape list.

The next field [AVAILABLE_SHAPES] identifies that the next series of lines will signify all of the shapes available for this Shape Group. The end of this field is reached when the [SHAPE_END] entry is read. The file below uses an asterisk (*) to specify that W24x68's and W24x76's are NOT available for this particular job.

The next field [OPTIMUM_SHAPES] identifies that the next series of lines will signify the preferred shapes for this Shape Group. The program will attempt to only use optimum shapes for beams that are significantly braced. By significantly braced, we mean that the unbraced length of the top flange is less than or equal to three feet. The end of this field is reached when the [SHAPE_END] entry is read.

The last field [END] identifies the end of the file.

[NAME]

Available W24s

[MATERIAL_TYPE]

Hot Rolled Steel

[MEMBER_TYPE]

Beam

[ASSOCIATED_DATABASE]

AISC

[END_HEADER]

[AVAILABLE_SHAPES]

W24X104

W24X103
W24X94
W24X84
*W24X76
*W24X68
W24X62
W24X55
[SHAPE_END]
[OPTIMUM_SHAPES]
W24X55
W24X62
*W24X68
W24X76
[SHAPE_END]
[END]

Creating or Modifying Design List

By default, RISA installs a series of default redesign lists for each material and member type. The default lists are assumed to be a compilation of what engineers would typically choose. To view the available sections for each list, you can open up the file located in the Redesign Lists folder using a word editing program.

To modify an existing redesign list, open the file in a word editing program to override any of the variables. The same formatting as the original file should be followed as well as saving the file to the same location, otherwise the program will not recognize the changes.

To create a new redesign list, open an existing file and run a Save As to save the file with a different file name in the same location. The [NAME] input as described in the above section will be the label you will see within the program so it is important to give your design list a unique name. The [MATERIAL_TYPE], [MEMBER_TYPE], and [ASSOCIATED DATABASE] are important criteria your member must have in order for the design list to be available. If a member in the model includes all three of the criteria defined in a particular design list, this design list will be available within spreadsheet pull down box .

Note:

- If you want to list a member size in the redesign list file but not have it considered as part of the redesign list, you can put an asterisk in front of the shape name.

Appendix B – Error Messages

Extensive error checking is performed during data entry and model solution in order to prevent you from having to scan input files for offending data. If an error or questionable entry is detected, an error or warning message will be displayed. Errors are divided into two groups such that data entry error numbers are between 1000-1999 and solution errors are between 2000-2999.

*Please refer to the **Help File** in RISA-2D for detailed information about each error message. The **Help File** may be accessed by selecting **Help Topics** from the **Help Menu**. Choose **Appendices : Appendix B - Error Messages**.*

Appendix E - Interfacing with Other Programs

RISA-2D interacts with a number of other RISA programs within the RISA suite (see below) as well as a the 3rd party programs listed in the sections below.

Integration with other RISA programs

For information on the integration between RISA-2D and RISASection see [Shape Databases](#).

For information on the integration between RISA-2D and RISAFoot see [RISAFoot Integration - Design](#).

Importing or Exporting DXF Files

For DXF importing / exporting, refer to the [DXF Files](#) section of the main manual.

Structural Desktop

Structural Desktop is a 3rd party program that works inside AutoCAD and is capable of importing RISA models into AutoCAD for the purposes of drawing production. Structural Desktop is also capable of exporting RISA files as well.

Structural Desktop also includes a library of steel joists that can be used directly inside of RISA-3D or 2D. Refer to the [Shape Database - General Shapes](#) section of the manual for more information.

For more information, see the RISA and Structural Desktop web sites:

risa.com/partners/prt_sdt.html

www.structuraldesktop.com

Appendix F – Wood Shear Wall Files

RISA-2D has design databases for wood shear walls and diaphragms which are used to optimize the nailing and hold downs for the wall. The criteria used for this optimization is specified on the Wood Wall (Fasteners) and Wood Diaphragms tabs of the **Design Rules** spreadsheet. In addition to this basic criteria, the user may specify a subset of the overall database from which the design / optimization must be performed.

Hold Downs

Label	Manufact...	Min Ch...	Req'd C...	Bolt Size	Defl at ...	CD Factor	Allowable...	CL[in]
HDU2-SDS2.5...	SIMPSON	3	DF	n/a	.088	1.600	3.075	1.313
HDU4-SDS2.5...	SIMPSON	3	DF	n/a	.114	1.600	4.565	1.313
HDU5-SDS2.5...	SIMPSON	3	DF	n/a	.115	1.600	5.645	1.313
HDU8-SDS2.5...	SIMPSON	3	DF	n/a	.084	1.600	5.98	1.375
HDU8-SDS2.5...	SIMPSON	3.5	DF	n/a	.116	1.600	6.97	1.375
HDU8-SDS2.5...	SIMPSON	4.5	DF	n/a	.113	1.600	7.87	1.375
HDU11-SDS2....	SIMPSON	5.5	DF	n/a	.137	1.600	9.535	1.375
HDU11-SDS2....	SIMPSON	7.25	DF	n/a	.137	1.600	11.175	1.375
HDU14-SDS2....	SIMPSON	5.5	DF	n/a	.177	1.600	14.375	1.563
HDU14-SDS2....	SIMPSON	7.25	DF	n/a	.177	1.600	14.445	1.563
HDU2-SDS2.5...	SIMPSON	3	HF	n/a	.088	1.600	2.215	1.313
HDU4-SDS2.5...	SIMPSON	3	HF	n/a	.114	1.600	3.285	1.313
HDU5-SDS2.5...	SIMPSON	3	HF	n/a	.115	1.600	4.065	1.313
HDU8-SDS2.5...	SIMPSON	3	HF	n/a	.084	1.600	4.305	1.375
HDU8-SDS2.5...	SIMPSON	3.5	HF	n/a	.116	1.600	5.02	1.375
HDU8-SDS2.5...	SIMPSON	4.5	HF	n/a	.113	1.600	5.665	1.375
HDU11-SDS2....	SIMPSON	5.5	HF	n/a	.137	1.600	6.865	1.375
HDU11-SDS2....	SIMPSON	7.25	HF	n/a	.137	1.600	8.045	1.375

Each database of hold downs is specified by an XML file in the "Hold Downs" sub-directory of the Wood Wall panels directory. The location of this directory is based on the information in the File Locations tab of the [Tools - Application Settings](#) dialog.

The program comes pre-loaded with three XML files, one for Simpson hold-downs, one for Canadian Simpson hold-downs, and one for USP hold-downs. The name of the XML file itself will be used in the list of databases in the Hold Down Schedule Dialog.

The first sheet of the XML file should always be descriptive of the contents of the database (such as **Simpson HoldDowns**). This is because the name used here is the name used in the Design Rules spreadsheet. This sheet contains all of the identifier, design and code check information used for each hold down. These entries are described below.

Full Database - Required Fields

The following fields are *required* information. If they are not provided or are left blank, then that hold down will not be available for use in that database.

The **Label** field is used to identify the hold down. This field must be referenced on the sheets that identify families or groups of hold downs. Maximum numbers of characters for this field is 32.

The **Deflection at Peak Load** entry is used to calculate the [deflection of the shear wall](#) per APA / NDS formulas. This deflection is then reported on the shear wall detail report for each wall panel.

The **CD Factor** is the assumed load duration factor that was used as the basis for specifying the listed **Allowable Tension** value for that hold down.

A load combination may be solved with a load duration factor different from the CD Factor described above. When this is the case, the **Allowable Tension** for that hold down will be adjusted based on the difference between the assumed and actual load duration factors.

Full Database - Optional Fields

The following fields are optional. They are not currently used in the design or capacity calculations, but are reported on the detail reports for reference purposes only.

The **Manufacturer** field is an identifier for the hold down. It is provided so that the engineer can more easily identify the callouts for their final design drawings.

The allowable capacity of the hold down will vary based on the Chord Thickness. Therefore, the **Min Chord Thickness** gives the minimum chord thickness that will yield the listed allowable tension load. However, this field is NOT currently used in the calculations. A future revision may provide a warning message if the actual chord thickness provided is less than required.

The allowable capacity of the hold down will vary based on the density of the wood species being used. Therefore, the **Required Chord Species** lists the density assumed for the entered allowable tension. However, this field is NOT currently checked in the calculations. A future revision may provide a warning message if the actual chord density provided is less than required.

The **Bolt Size** when specified is used to reduce the axial capacity of the hold down chord itself. The only change to the calculation is that the program will perform the allowable tension check on the net area of the chord member rather than the gross area.

Grouping Hold Down Schedules for Design Optimization

The other sheets allow the user to group hold downs together into families for optimization purposes. These additional sheets CANNOT be the first sheet in the XML file as that first sheet must always be the one where the full database information resides.

The hold down labels specified on these sheets refer only to hold downs that have already been defined on the full database sheet. The information in this sheet need not be organized in a specific order. Instead, they will always be optimized based on the assumption that the hold down cost is directly related to the tension capacity. Therefore, when this group is selected, then the hold down within the group with the code check closest to unity, but still less than 1.0 will get selected during the optimization process.

Straps

Strap Schedule

Select Manufacturer
Simpson Chord Strap

Available Strap Series
SIMPSON Catalog
CMST_DF-SP
CMST_SPF-HF
CS_DF-SP
CS_SPF-HF
MST_DF-SP
MST_SPF-HF
HST_DF-SP
HST_SPF-HF

Label	Manufact...	Clear S...	End Le...	Reqd C...	Fasten...	Numbe...	Fasten...	CD Factor	Allowable...
MSTA49_18_...	SIMPSON	18	n/a	DF/SP	Nail	26	10d	1.6	2.02
MSTA49_16_...	SIMPSON	16	n/a	DF/SP	Nail	26	10d	1.6	2.02
MSTC28_18_...	SIMPSON	18	n/a	DF/SP	Nail	12	16d_si...	1.6	1.155
MSTC28_16_...	SIMPSON	16	n/a	DF/SP	Nail	16	16d_si...	1.6	1.54
MSTC40_24_...	SIMPSON	24	n/a	DF/SP	Nail	20	16d_si...	1.6	2.31
MSTC40_18_...	SIMPSON	18	n/a	DF/SP	Nail	28	16d_si...	1.6	2.695
MSTC40_16_...	SIMPSON	16	n/a	DF/SP	Nail	32	16d_si...	1.6	3.08
MSTC52_24_...	SIMPSON	24	n/a	DF/SP	Nail	36	16d_si...	1.6	3.465
MSTC52_18_...	SIMPSON	18	n/a	DF/SP	Nail	44	16d_si...	1.6	4.235
MSTC52_16_...	SIMPSON	16	n/a	DF/SP	Nail	48	16d_si...	1.6	4.62
MSTC66_30_...	SIMPSON	30	n/a	DF/SP	Nail	48	16d_si...	1.6	4.78
MSTC66_24_...	SIMPSON	24	n/a	DF/SP	Nail	54	16d_si...	1.6	5.38
MSTC66_18_...	SIMPSON	18	n/a	DF/SP	Nail	64	16d_si...	1.6	5.86
MSTC66_16_...	SIMPSON	16	n/a	DF/SP	Nail	68	16d_si...	1.6	5.86
MSTC78_30_...	SIMPSON	30	n/a	DF/SP	Nail	64	16d_si...	1.6	5.86
MSTC78_24_...	SIMPSON	24	n/a	DF/SP	Nail	72	16d_si...	1.6	5.86
MSTC78_18_...	SIMPSON	18	n/a	DF/SP	Nail	76	16d_si...	1.6	5.86
MST37_24_D...	SIMPSON	24	n/a	DF/SP	Nail	14	16d	1.6	1.725

Current Selection Type
Use Entire Series SERIES

Save As Defaults OK Cancel Help

Each database of straps is specified by an XML file in the "Straps" sub-directory of the Wood Wall panels directory. The location of this directory is based on the information in the File Locations tab of the [Tools - Application Settings](#) dialog.

The program comes pre-loaded with a database for Simpson Chord Straps. The name of the XML file itself will be used in the list of databases in the Strap Schedule Dialog.

The first sheet of the XML file should always be descriptive of the contents of the database (such as **Simpson Chord Straps**). This is because the name used here is the name used in the Design Rules spreadsheet. This sheet contains all of the identifier, design and code check information used for each strap. These entries are described below.

Full Database - Required Fields

The following fields are *required* information. If they are not provided or are left blank, then that strap will not be available for use in that database.

The **Label** field is used to identify the strap. This field must be referenced on the sheets that identify families or groups of straps. Maximum numbers of characters for this field is 32.

The **CD Factor** is the assumed load duration factor that was used as the basis for specifying the listed **Allowable Tension** value for that hold down.

A load combination may be solved with a load duration factor different from the CD Factor described above. When this is the case, the **Allowable Tension** for that hold down will be adjusted based on the difference between the assumed and actual load duration factors.

Allowable Tension is the value the program will use when designing the strap to be used.

Full Database - Optional Fields

The following fields are optional. They are not currently used in the design or capacity calculations, but are reported on the detail reports for reference purposes only.

The **Manufacturer** field is an identifier for the strap. It is provided so that the engineer can more easily identify the callouts for their final design drawings.

The **Clear Span** is the distance the strap is required to span between elements it is resisting the tension of.

End Length is the length of the strap that extends past the clear span

The allowable capacity of the strap will vary based on the density of the wood species being used. Therefore, the **Required Chord Species** lists the density assumed for the entered allowable tension. However, this field is NOT currently checked in the calculations. A future revision may provide a warning message if the actual chord density provided is less than required.

The **Fastener Type** shows whether Nails or Bolts is used to fasten the strap to the tension chords.

The **Number of Fasteners** field show how many fasteners are required to be used to meet the requirements of the tension capacity given by the strap.

Grouping Strap Schedules for Design Optimization

The other sheets allow the user to group straps together into families for optimization purposes. These additional sheets CANNOT be the first sheet in the XML file as that first sheet must always be the one where the full database information resides.

The strap labels specified on these sheets refer only to straps that have already been defined on the full database sheet. The information in this sheet need not be organized in a specific order. Instead, they will always be optimized based on the assumption that the strap cost is directly related to the tension capacity. Therefore, when this group is selected, then the strap within the group with the code check closest to unity, but still less than 1.0 will get selected during the optimization process.

Panel Nailing Schedules

Wood Wall Panel Schedule

Select Code: IBC_06-09

Available Panel Groups:

- IBC06-09 Panel Database
- 0.3125 Panel Group
- 0.375 Panel Group
- 0.4375 Panel Group
- 0.469 (8d) Panel Group
- 0.469 (10d) Panel Group

Label	Grade	Min T...	Min Pe...	Over Gyps...	One/Tw...	Nail Size	Staple Size	Nai...	Shear Capa...
S1_5/16_6d@6	St-I	.313	1.25	No	1	6	n/a	6	.2
S1_(2)5/16_6d@6	St-I	.313	1.25	No	2	6	n/a	6	.4
S1_3/8_8d@6	St-I	.375	1.375	No	1	8	n/a	6	.23
S1_(2)3/8_8d@6	St-I	.375	1.375	No	2	8	n/a	6	.46
S1_7/16_8d@6	St-I	.438	1.375	No	1	8	n/a	6	.255
S1_(2)7/16_8d@6	St-I	.438	1.375	No	2	8	n/a	6	.51
S1_15/32_8d@6	St-I	.469	1.375	No	1	8	n/a	6	.28
S1_(2)15/32_8d@6	St-I	.469	1.375	No	2	8	n/a	6	.56
S1_15/32_10d@6	St-I	.469	1.5	No	1	10	n/a	6	.34
S1_(2)15/32_10d@6	St-I	.469	1.5	No	2	10	n/a	6	.68
S1_5/16_6d@4	St-I	.313	1.25	No	1	6	n/a	4	.3
S1_(2)5/16_6d@4	St-I	.313	1.25	No	2	6	n/a	4	.6
S1_3/8_8d@4	St-I	.375	1.375	No	1	8	n/a	4	.36
S1_(2)3/8_8d@4	St-I	.375	1.375	No	2	8	n/a	4	.72
S1_7/16_8d@4	St-I	.438	1.375	No	1	8	n/a	4	.395
S1_(2)7/16_8d@4	St-I	.438	1.375	No	2	8	n/a	4	.79
S1_15/32_8d@4	St-I	.469	1.375	No	1	8	n/a	4	.43

Current Selection Type: Select Entire Panel Group INDIVIDUAL

Buttons: Save As Defaults, OK, Cancel, Help

Each database of wall panels is specified by an XML file in the "Shear Panels" sub-directory of the Wood Wall panels directory. This directory is located based on the information File Locations tab of the [Tools - Application Settings](#) dialog.

The program comes preloaded with XML files, including OSB and Plywood databases from the American Wood Council's 2015 *Special Design Provisions for Wind and Seismic*.

Note:

- The 2015 IBC refers directly to AWC SDPWS 2015 instead of publishing separate IBC tables as in previous versions.

The first sheet of the XML file should always be descriptive of the contents of the database (such as **IBC 2012**). This is because the name used here is the name used in the Design Rules spreadsheet. This sheet contains all of the identifier, nailing, design and code check information for each nailing schedule. These entries are described below.

Full Database - Required Fields

The following fields are *required* information. If they are not provided or are left blank, then that nailing schedule will not be available for use in the database.

The **Label** field is used to identify the panel schedule and its nailing requirements. This field must be referenced on the sheets that identify families or groups of panels. Maximum numbers of characters for this field is 32.

Note:

- Panels with a label containing the characters "_W" together will be ignored during design optimization.

The **Min Panel Thickness** is used during the design optimization to limit the selected panels based on the Design Rules chosen by the user. It is also used to help set the elastic stiffness of the wall panel used during the FEM solution.

The **Ga** value is the **Apparent Shear Stiffness** from nail slip and panel deformation as defined in [equation 4.3-1](#) of the NDS' Special Design Provisions for Wind and Seismic. This value (in combination with the Min Panel Thickness defined above) is used to set the elastic stiffness of the wall panel that will be used during the FEM solution.

Note:

- When a family or group of panels / nailing schedules are assigned to a shear wall, the lowest value of Ga and Min Panel thickness will be used to determine the elastic stiffness of the plate elements in the FEM solution.

The **One/Two Sided** field is used during the design optimization to limit the available panels based on the Design Rules specified by the user.

The **Boundary Nail Spacing** field is used during the design optimization to limit the available panels based on the Design Rules specified by the user.

Note:

- The maximum field spacing is never entered in the program but is generally equal to 12 inches for the nailing schedules defined in the 1997 UBC and 2006 IBC databases. If a different nail spacing is present, then the user should add in a new nailing schedule to the existing database with a user defined shear capacity.

The **Shear Capacity** listed in the spreadsheet is the primary value that controls the code checking of the shear wall. This is the seismic capacity, which the program can automatically increase for wind loads if the [Wind ASIF](#) function is enabled.

Full Database - Optional Fields

The following fields are optional. They are not currently used in the design or capacity calculations, but are reported on the detail reports for informational purposes only.

The **Panel Grade** and **Min Penetration** fields are identifiers for the engineer, but are not used in the design calculations. They are provided so that the engineer can most easily identify the panels in their design results and drawings.

The **Panel Applied Over Gypsum** field is also a identifier for the engineer that will not be used in the design calculations.

The **Nail Size** listed in the spreadsheet is intended to refer to the Common nail size, but is reported only for reference purposes and are NOT used in the capacity calculations. If the nail size is changed by the user, then the user should also change the Shear Capacity entry accordingly. Below is a reference table for common, box, and sinker nails.

Penny Weight	Diameter				Length	
	Common (in)	Common (Wire Gage)	Box (in)	Sinker (in)	Box and Common (in)	Sinker (in)
6d	0.113	11.5	0.099	0.092	2	1.875
7d	0.113	11.5	0.099	0.099	2.25	2.125
8d	0.131	10	0.113	0.113	2.5	2.375
10d	0.148	9	0.128	0.120	3	2.875
12d	0.148	9	0.128	0.135	3.25	3.125
16d	0.162	8	0.135	0.148	3.5	3.25

The Staple size listed in the database is reported for reference purposes only. If the staple size is entered or changed by the user, then the user should also change the shear capacity entry to the appropriate value.

Grouping Panel / Nailing Schedules for Design Optimization

The other sheets in the database allow the user to organize multiple nailing schedules into groups or families for design optimization purposes. These additional sheets CANNOT be the first sheet in the XML file as that first sheet must always be the one where the full database information resides.

The panel labels specified on these sheets refer only to panel / nailing schedules that have already been defined on the full database sheet. The information in this sheet need not be organized in a specific order. Instead, they will always be optimized based on the assumption that the installed cost is directly related to the shear capacity. Therefore, when a group or family is selected, then the nailing schedule within the group with the code check closest to unity, but still less than 1.0 will get selected during the optimization process.

- The 2015 IBC refers directly to AWC SDPWS 2015 instead of publishing separate IBC tables as in previous versions.

Appendix G – CFS Shear Wall Files

RISA-2D has design databases for CFS shear walls which are used to optimize the nailing for the wall. The criteria used for this optimization is specified on the CFS Wall (Fasteners) tab of the **Design Rules** spreadsheet. In addition to this basic criteria, the user may specify a subset of the overall database from which the design / optimization must be performed.

Panel Nailing Schedules

Cold Form Wall Panel Schedule

Select Code: CFS Wood Sheathing

Available Panel Groups: AISI 2015 Wood

Label	She...	4:1 A...	Sheet ...	Fastener ...	Stud Blo...	Min Me...	Min Scre...	Go...	Shear Capa...
15/32_S1@6/12_43	Wo...	No	0.469	6	Yes	43	0	No	1.065
15/32_S1@4/12_43	Wo...	No	0.469	4	Yes	43	0	No	1.41
15/32_S1@3/12_43	Wo...	No	0.469	3	Yes	43	0	No	1.735
15/32_S1@2/12_43	Wo...	No	0.469	2	Yes	43	0	No	1.91
7/16_OSB@6/12_33	Wo...	No	0.438	6	Yes	33	0	No	0.91
7/16_OSB@4/12_33	Wo...	No	0.438	4	Yes	33	0	No	1.41
7/16_OSB@3/12_33	Wo...	No	0.438	3	Yes	33	0	No	1.735
7/16_OSB@2/12_33	Wo...	No	0.438	2	Yes	33	0	No	1.91
7/16_OSB@4/12_33...	Wo...	Yes	0.438	4	Yes	33	0	No	1.025
7/16_OSB@3/12_33...	Wo...	Yes	0.438	3	Yes	33	0	No	1.425
7/16_OSB@2/12_33...	Wo...	Yes	0.438	2	Yes	33	0	No	1.825
15/32_S1@6/12_33...	Wo...	Yes	0.469	6	Yes	33	8	Yes	0.78
15/32_S1@4/12_43...	Wo...	Yes	0.469	4	Yes	43	8	Yes	0.99
15/32_S1@6/12_43...	Wo...	No	0.469	6	Yes	43	8	Yes	0.89
15/32_S1@4/12_43...	Wo...	No	0.469	4	Yes	43	8	Yes	1.33
15/32_S1@3/12_43...	Wo...	No	0.469	3	Yes	43	8	Yes	1.775
15/32_S1@2/12_43...	Wo...	No	0.469	2	Yes	43	8	Yes	2.19

Current Selection Type: GROUP

Select Entire Panel Group

Save As Defaults OK Cancel Help

Each database of wall panels is specified by an XML file in the "Shear Panels" sub-directory of the CFS Wall panels directory. This directory is located based on the information File Locations tab of the [Tools - Application Settings](#) dialog.

The program comes preloaded with XML files, including Wood, Steel sheet, Fiberboard, and Gypsum databases based on the AISI S240-15 and AISI S400-15 codes.

The first sheet of the XML file should always be descriptive of the contents of the database (such as **AISI 2015 Wood**). This is because the name used here is the name used in the Design Rules spreadsheet. This sheet contains all of the identifier, nailing, design and code check information for each nailing schedule. These entries are described below.

Full Database - Required Fields

The following fields are *required* information. If they are not provided or are left blank, then that nailing schedule will not be available for use in the database.

The **Label** field is used to identify the panel schedule and its nailing requirements. This field must be referenced on the sheets that identify families or groups of panels. Maximum numbers of characters for this field is 32.

Note:

- Panels with a label containing the characters "_W" together will be ignored during design optimization.
- Panels containing the same exact label name as a preceding panel will be ignored and will not be loaded into the program.

The **Type of Wall** dictates the design method that this row should be associated with.

The **Sheathing Material** indicates which material of the sheathing. This should be Wood Structural, Steel Sheet, Fiberboard or Gypsum Board Panels.

The **2:1 to 4:1?** column should only contain a yes or no entry. “No” means that the row will only apply for walls with height-to-width ratios up to 2:1. “Yes” means that the row only applies for walls with height-to-width ratios greater than 2:1 but less than 4:1.

The **Thickness** column is used during the design to help set the elastic stiffness of the wall panel used during the FEM solution.

The **Fastener Spacing** is used during the design optimization to limit the available panels based on the Design Rules specified by the user.

The **Min Member Thickness** is used in the design optimization to pick a sheathing configuration that satisfies the minimum required stud thickness. For wood sheathing, this column is treated as the required thickness since AISI S400 does not permit any other thickness to be used for the wood sheathing case.

Stud thickness	Sheathing entries with Min Member Thickness values equal to:
XXXSXXX - 33	33
XXXSXXX - 43	33, 43
XXXSXXX - 54	33, 43, 54

The **Gov by S400 (EL)** determines whether this sheathing configuration comes from the AISI S400-15 code or not. This column should only contain a yes or no entry. A “no” entry means that this configuration comes from AISI S240-15 and will only be applied to load combinations that do not contain earthquake load categories. A “yes” entry means that this configuration is pulled from the AISI S400-15 provisions and will only be applied when the load combination contains an earthquake load category (EL, ELX, ELZ, etc).

The **Shear Capacity** listed in the spreadsheet is the primary value that controls the code checking of the shear wall. This is the nominal lateral capacity of the shear wall that is pulled directly from the tables in AISI S240 and S400. The program will then apply the appropriate factors depending on if ASD or LRFD design is selected.

The **Shear Modulus** is (in combination with the panel Thickness defined above) is used to set the elastic stiffness of the wall panel that will be used during the FEM solution. This value is also used in the reported design deflection calculation for wood or steel sheathed panels.

For 7/16” OSB, we are assuming 24/16 OSB rated sheathing and approximating G based on AISI S240-15-C pg. 30. $CGGVtV = 177,300$ psi

For Struct 1 sheathing (4-ply) we are using IBC values assuming 24/16 rated sheathing. The values reported in the table are given in lb/in. For the values input in the spreadsheets that we’ll use, we take this value and divide by the panel thickness to get this in psi which is required in the deflection calculation.

Note:

- When a family or group of panels / nailing schedules are assigned to a shear wall, the lowest value of Shear Modulus and Min Panel thickness will be used to determine the elastic stiffness of the plate elements in the FEM solution.

Full Database - Optional Fields

The Min Screw Size listed in the spreadsheet is reported only for reference purposes and are NOT used in the capacity calculations.

Grouping Panel / Nailing Schedules for Design Optimization

The other sheets in the database allow the user to organize multiple nailing schedules into groups or families for design optimization purposes. These additional sheets CANNOT be the first sheet in the XML file as that first sheet must always be the one where the full database information resides.

The panel labels specified on these sheets refer only to panel / nailing schedules that have already been defined on the full database sheet. The information in this sheet need not be organized in a specific order. Instead, they will always be optimized based on the assumption that the installed cost is directly related to the shear capacity. Therefore, when a group or family is selected, then the nailing schedule within the group with the code check closest to unity, but still less than 1.0 will get selected during the optimization process.

Technical Support

Technical support is an important part of the RISA-2D package. There is no charge for technical support for all licensed owners of, or subscribers to, the **current** version of RISA-2D. Technical support is very important to the staff at RISA Tech, Inc.

Hours: 6AM to 5PM Pacific Time, Monday through Friday (excluding holidays)

Before contacting technical support, you should typically do the following:

1. **Please search the Help File or General Reference Manual.** The Help File and General Reference are meant to cover most common questions asked about RISA-2D. The Table of Contents or Search can be used to find specific topics. This is a good first step in finding the answer to your question. It is also good practice to go through all of the Tutorials when you first get the program. This will help you get a feel for the program and likely increase your modeling confidence.
2. Ensure that you are running the latest version of the software. Under the *Help* menu click **Check for Updates**
3. Visit our website at risa.com.
4. Make sure you understand the problem, and make sure your question is related to the program or structural modeling.
5. Take a few minutes to experiment with the problem to try to understand and solve it.

Email: support@risa.com. If your question is related to a specific model, please send us that model. That makes it much easier for us to debug a problem or answer questions about specific issues. The model file has a .R2D extension. Make sure you tell us your name, company name, serial number, Key ID, or Cloud ID, phone number, and give a thorough problem description. If you have multiple members, plates, or load combinations, make sure you specify which ones to look at.

Phone Support: (949) 951-5815. Feel free to call, especially if you need a quick answer and your question is not model specific and therefore doesn't require us to look at your file.

Index

2

2010 NBC 105
2015 NBC 105
2016 ASCE 105
2D Models 25

A

Accelerated Solver 349
Acceleration (spectral) 99
Adding Shapes 16, 27, 169, 341
AISC 13th and 14th Editions - Design Guide
25 191
AISC Code Check Results 195
AISC Design Code Limitations 179
AISC Design Code Special Messages 181
AISC Design Codes 177
ALL Boundary Condition 25
Aluminum - Design 19
Aluminum Design
Limitations 22
Results 20
Aluminum Design Parameters 19
Aluminum Detail Report 21
Aluminum Unbraced Length 19
Ambient Temperature 209
Animation 137
Animating Deflections 137
Animating Mode Shapes 98
Animating Moving Loads 241
Appending Files 109
Application Interface 4
Application Settings 67

Applying Changes 140
Applying Loads 215
Arbitrary Shapes 342
Arc Generation 114
Circular Arc 114
Parabolic Arc 114
Australian & New Zealand Design Codes 189
Australian & New Zealand Design Codes - Lim-
itations 190
Australian Code Check Results 204
Automatic Backup 67
Customizing 67
File Operations 110
Automatic Generation 112
Axes
Member Local Axes 270
Plate Local Axes 308
Plot Options 138
Axial Force 279
Axial Stress 280

B

Background 138
Backup 67, 110
Customizing 67
File Operations 110
Bar Shapes 173
Database 173
Limitations 180
Batch Solution 348
Beam Stability Factor (wood) 520
Black Background 138

- Block operations (spreadsheet) 5
- Block Operations (spreadsheet) 351
- Boundary Conditions 23, 382
 - All 25
 - Creating and Modifying 23
 - Display 131
 - Fixed 25
 - Reaction 25
 - Slave Joints 26
 - Spreadsheet 24
 - Springs 25
- Box Selections 158
- Braces 214
- British Code Check Results 198
- British Design Code - Limitations 185
- British Design Code - Member Design Parameters 184
- Building a Report 327
- Building Codes 104, 225
- C**
- Cables 290
- Canadian Code Check Results 196
- Canadian Design Codes - Limitations 182
- Canadian Design Codes - Member Design Parameters 182
- Canadian Design Codes - Special Messages 184
- Cb Factor (AISC) 177
- Center of Gravity 212
- CFS View Controls 394
- CFS Wall - Design 393
- CFS Wall Detail Reports 407
- CH factor (Wood) 521
- Channel Shapes 171
- Circular Generation 114
 - Arc 114
- Disk 119
 - Radius 119
- Clearing Cells 354
- Cloning Views 127
- Cm Coefficient 252
 - Cold Formed 31
 - Concrete 45
 - Hot Rolled 177
 - Wood (moisture) 252
- Coefficient of thermal Expansion 252
- Cold Formed Steel Design 30
 - AISI 30
 - Bending Coefficients 31
 - Limitations 34
 - R-Value 31
 - Results 32
- Color 132-133, 138
- Column Stability Factor (Wood) 520
- Commands 4
 - Main Menu 4
 - Shortcuts and Hot Keys 12
- Company Name (printed) 330
- Compression Only 25
 - Member 265
 - P-Delta 296
 - Springs 25
- Compressive Strength 253
- Concrete Cover 76
- Concrete Design 42
 - Beam Results 54
 - Code Options 42
 - Controlling Bar Sizes 75
 - Cover 75
 - Cracking 45-46
 - Design Rules 75

-
- Detail Reports 58
 - K Factors 44
 - Limitations 50
 - Messages 52
 - Rebar Layout 37
 - Rebar Layout (Beams) 46
 - Rebar Layout (Columns) 45
 - Spans 42
 - Stress Block 48
 - Sway 45
 - T-beams & L-beams 47
 - Tie Spacing 125
 - Unbraced Lengths 43
 - Concrete Design Considerations 414
 - Concrete Design Results 54
 - Concrete Lintel Considerations 419
 - Concrete Reinforcing Spreadsheet Results 425, 457
 - Concrete Stiffness 46
 - Icracked (Beams) 46
 - Icracked (Columns) 45
 - Service Level Stiffness (beams) 47
 - Service Level Stiffness (columns) 45
 - Concrete Wall Design 413
 - Concrete Wall Design Rules 421
 - Concrete Wall Detail Reports 426
 - Concrete Wall Modeling Considerations 420
 - Concrete Wall Regions 414
 - Concrete Wall Results 425
 - Concrete Wall Spreadsheet Results 425
 - Concrete Wall View Controls 413
 - Cone Generation 118
 - Context Help 168
 - Continuous Beam Generation 112
 - Convergence 296
 - Dynamics 94
 - P-Delta 123, 296
 - T/C Members and Springs 25, 265
 - Work Vectors 95
 - Coordinates 13
 - Copy 147
 - Linear Copy 147
 - Loads 218
 - Mirror Copy 149
 - Rotate Copy 148
 - Spreadsheet Cells 354
 - Corner Forces 314
 - Cover 76
 - CQC Method 101
 - Cr factor (Wood) 521
 - Creating Openings 380
 - Creating Regions 381
 - Criteria Selections 159
 - Crossing Members 285
 - CS shapes 29
 - CS Shapes 18
 - CSA 086 Adjustment Factors 522
 - CU shapes 28
 - Custom Shapes 342
 - Arbitrary 342
 - Cold Formed 27
 - Hot Rolled 169
 - Customizable Model View Toolbar 8
 - Customization 67
 - CV 520
 - Cylinder generation 118
- D**
- Damping Ratio 103

- Data Entry Preferences 67
- Data Entry Toolbar 11
- Database 341
 - Aluminum 17, 342
 - Arbitrary Shapes 342
 - Cold Formed 28, 341
 - Concrete 37, 341
 - Hot Rolled Steel 169, 341
 - NDS Wood 341, 510
 - On-Line Shapes 345
 - RISA Section 343
 - Structural Desktop (SDT) 344
- Date 328
- Defaults 67, 356
 - Load Combinations 220
 - Materials 251
 - Mode 15
 - Plot Options 131
- Deflection Ratio Option 265
- Deflection Ratio Options 272
- Degrees of Freedom (DOF's) 24
- Deleting 155
- Density 252
 - Material Properties 252
 - Self Weight 215
- Depth Effect (Graphics) 130
- Design Lists 527
- Design Parameters 258
 - Cold Formed 30
 - Concrete Beams 46
 - Concrete Columns 43
 - Hot Rolled 177
 - Wood 518
- Design Rules 74
 - Concrete 75
 - Deflection 75
 - Size/UC 74
- Detail Reports 333
 - Concrete Detail Reports 58
- Dialog Boxes 15
- Direct Analysis Method 124, 296
- Direct Analysis Method - Ratio 84, 299
- Direct Analysis Method - Stiffness Reduction 178
- Discretizing Mass 95
- Disk Generation 119
- Displacements 212
- Distance Tool 12
- Distortion 310
- Distributed Loads 236
 - Directions 238
 - Drawing 236
 - Spreadsheet 237
- Dome 114
- Double Angles 172, 191
 - Database 172
 - Limitations 180
- Drawing 140
 - Boundaries 23
 - Distributed Loads 236
 - Grid 141
 - Import DXF 145
 - Joint Loads 229
 - Loads 215
 - Members 258
 - Plates 300
 - Point Loads 233
 - Snap Points 144
 - Wall Panels 374
- Drawing Grid 382

Drawing Toolbar 10
Drift 81
 Defining Story Joints 26
Drift - Seismic 83
DXF Files 86
Dynamic Analysis 93, 99, 348
Dynamic Pan / Zoom / Rotate 11

E

E (Young's Modulus) 251
Edit menu 5
Edit mode 15
Eigensolution 93
Email (support) 541
Emin Calculation 524
Enforced Displacements 230, 291
Envelope Solution 348
Error Messages 530
EuroCode Code Check Results 200
EuroCode Design Codes - Limitations 187
EuroCode Design Codes - Member Design Parameters 185
EuroCode Design Codes - Special Messages 188
Excluding Results 275, 332
Exporting Files 110

F

F'm compressive strength 254
Fc' (compressive strength) 253
File Locations 72
File Menu 4
File Operations 109
Filling Spreadsheets 353
Find 355
Fixed Boundary Conditions 25

Flat File 328
Flat Use Factor -CSA 523
Flat Use Factor (Wood) 521
Fluid Density 118
Font Control 71
Form Factor (wood) 521
Frequencies 96
 Convergence 94
 Number of Modes 94
 Trouble Shooting 98
 Work Vectors 95
Fu (Ultimate Stress) 252
Fy (Yield Stress) 252

G

G (shear Modulus) 251
General Member Design Limitations 190
General Preferences 67
Generation 112
 Arcs 114
 Cones 118
 Continuous Beams 112
 Cylinders 118
 Disk 119
 Members 115
 Plates 118
 Radius 119
 Tanks 118
 Trusses 116
Geodesic Dome Generation 118
geometric axes 367, 369
Global Axes 138
Graphic 127
 Display 127
 Editing 140

Printing 330
Results 333
Selection 157
Grid 141
 Drawing 141
Grid Increments 382
Gupta method 101

H

Hardware Requirements 1
Help Menu 7
Help Options 168
Hold Downs 394, 469
Hot Keys 12
Hot Rolled Steel Design 175
 AISC
 ASD Limitations 180
 Allowable Stress Increase Factor 178
 Code Limitations 175
 K Factors 369
 Lateral-Torsional Buckling Modification
 Factor 177
 Parameters 177
 Results 195
HSS Shapes 170
HU Shapes 29

I

I-Joint 263
Icr (Concrete Walls) 378
Importing Files 110
Inactivating
 Members 275
 Plates 307
Inclined Supports/Reactions 291
Indian Design Codes - Limitations 189

Indian Design Codes - Member Design Parameters 188
Information Dialog 210
 Joints 210
 Members 268
 Plates 306
Insert Cells 354
Insert Menu 6
Interactive Diagrams 335
Interface 4
Inverting Selections 158
Isometric View 5, 127
Iterations 265
 Dynamic Analysis (subspace iterations) 94
 P-Delta 296
 T/C Members 265
 T/C Springs 24

J

J-Joint 263
Joints 209
 Displacements 212
 Loads 229
 Mass 230
 Reactions 212
 Results 212
 Slaving 214

K

K-Joint 263
K (Concrete Walls) 379
K Factors 369
Keyboard Commands 12
Kf Factor 521

L

L Shapes 18, 172
Labels 75, 129, 263, 305
Lateral Stability Factor - CSA 523
Layers (CAD) 86
Lbyy 366
Lbyy, Lbzz or Lb-in Lb-out 43, 363
License Agreement 2
Limitations 420
Limits 2
Line Selections 158
LL Shapes 172
Load Attribution 384
Load Combinations 220
 Design Options 222
Load Duration Factor - CSA 522
Loads 215
 Cases 217, 221
 Categories 218, 221
 Combinations 220
 Display 136
 Duration factors 225, 519
 Joint Loads 229
 Member Loads 233, 236, 249
 Nodal Loads 229
 Path 243
 Time Effect Factor 522
Local Axes 270
 Members 132, 263, 270
 Plates 133, 308
Local Modes 94, 98
Locked Joints 358
Locking Selections 163
Lumped Mass 95

M

Main Menu 4
Maintenance (program) 2
Manuals 1
Masonry - Suggested Design 440
Masonry Lintels 435
Masonry Regions 437
Masonry View Controls 435
Masonry Wall Design 442
Masonry Wall Design Rules 452
Masonry Wall Detail Reports 457
Masonry Wall Modeling 435
Masonry Wall Optimization 438
Masonry Wall Results 456
Mass 94
 Dynamics 94
 Joint Load 230
 Nodal Load 230
Mass Moment of Inertia 231
Master Joints 26, 214
Material Properties 251
Material Set 377
Material Take-Off 256
Material Type 377
Member Design Lists 74
Member Design Rule Editor 76
Member Shear Areas 276
Members 257
 Bending Stress 280
 Deflections 283
 Detail Reports 333
 Drawing 257
 End Offsets 275
 End Releases 272

Forces 279
Generation 112, 115
Inactive 275
Local Axes 270
Modifying 258
Modifying Design Parameters 260
Orientation 270
Physical 269
Results 278
Shear Area 276
Sign Convention 279
Splitting 261
Spreadsheet 262
Stresses 280
Menus 4
Merge Lintels 438
Messages 509, 530
 Error Message 530
 Warning Log 509
Mirror 149
Modal Combination 101
Modal Frequency 96, 100
Mode Shapes 97
Model Display Options 131
Model Merge 152, 285
Model Settings 121
 Codes 124
 Concrete 125
 Description 121
 Solution 122
Model View 14, 127
Modeling Tips 289
 Applying in-plane moment to plates 289
 Beam fixed to a shear wall 289
 Cables 290

Dynamics 95
Inclined Supports / Reactions 291
Plates 309
Reaction at enforced displacement 291
Rigid Links 292
Modes (program) 15
Modify Menu 6
Modifying
 Members 258
 Plates 302
 Wall Panels 375
Modifying Loads 216
Moving Elements 150
Moving Load Step Point Load Generation 246
Moving Loads 241

N

NDS 516
Nesting load combinations 224
New Models 67
New Zealand Code Check Results 205
Nodes 212
 Loads 229
 Mass 230
Normal Stress 313
NPS Shapes 18
Nu (Poisson's Ratio) 251
Number of Sections 278

O

OD Shapes 18
On-Line Help 168
On-Line Shapes 345
On-Line website 168
One-way members 265

One-way springs 25

Openings 380

Optimization 74

Optimization Results 79

Options 67

Overview 1

P

P-Delta 221, 294

 Including P-Delta in a Load Combination 221

 Turning off the P-Delta Requirement 69

P-Little Delta - AISC DAM 299

P - Little Delta Analysis 298

Page Number (for printing) 327

Panning (graphics) 128

Parabolic Arc Generation 114

Partial Views 130

Participation (mass) 94, 96, 98, 101

Participation factors 96, 101

Paths 72, 243

Patterns 243

Phone (support) 541

Physical members 265, 269

Pins 272, 307

 Boundary Conditions 23

 Corner Releases 307

 End Releases 272

Pipe Shapes 171, 345

Plane Stress 311

Plates 300

 Convention 311

 Convergence 323

 Corner Forces 314

 Corner Releases 307

 Drawing 300

Dynamics 95

Examples 320

Forces 313

Generation 310

Inactive 307

Information Dialog 306

Local Axes 302, 308

Mesh 310

Mesh Transition 323-324

Plane Stress 311

Results 313

Spreadsheet 305

Stresses 313

Sub-meshing 304

Point Loads 233

 Drawing 233

 Spreadsheet 234

Poisson's Ratio 251

Polar Copy 148

Polar Move 150

Polar Origin

 Arc Generation 114, 119

 Move / Copy 148, 150

Polygon Selections 158

Prestressing 250

principal axes 367, 369

Principal Stresses (Plates) 313

Printing 326

Program Defaults 67

Program Limits 2

Program Modes 15

Projected Loads 238

Q

Quadrilateral element 309

R

Radius Generation 115
Re-Labeling 209, 263, 305
Re-Labeling Selected Elements 156
Reactions 25
 Boundary Condition 25, 212, 291
Rectangular Drawing Grid 142
Rectangular Shapes 37, 173, 345
Redo 141, 352
Regions 381
Releases 265, 272, 307
Rendering (Graphics)
 Members 132
 Plates 133
Reports 327, 332
Required Modes 94, 101
Residual Mass 96
Resistance Factor 522
Response Spectra Analysis 99
 Load Combinations 222
 Plotting Spectra 106-107
 Solution 349
 Trouble Shooting 98
Results 212, 331
 Joints 212
 Members 278
 Menu 6
 Plates 313
 Preferences 69
 Toolbar 11
Right-Click Menu 7
Rigid Links 292
RISA-2D Files 110
RISA Toolbar 7

RISAFloor
 Diaphragm Mass 231
RISASection 343
Ritz Vector Solver 349
Rotating 11, 128
 Elements 150
 Views 128, 138

S

Save As Defaults 67
Saving 4
 Dynamic Results 94
 Files 4
 Results 331
 Selections 167
 Views 130
Scaling Elements 151
Scaling Spectra 103
Scrolling 351
Secondary Effects 294
Section Properties 340-341
Section Results 278
Section Sets 339
Select By Property
 Coordinates 163
 Members 160
 Nodes 159
 Plates 161
 Wall Panels 162
Select Mode 15, 158
Selection 9
 Toolbar 9
 Using Graphics 157
 Using Spreadsheets 166

-
- Self-Weight 215
 - Dynamic Analysis 95
 - Material Density 252
 - Service Condition Factor 522
 - Shape Database 341
 - Cold Formed Steel 16, 27
 - Concrete 37
 - General 341
 - Hot Rolled Steel 169
 - Wood 510
 - Shear 276
 - Area Coeff (for Deformation) 276
 - Area Coeff (for Stress) 276
 - Deformation 276
 - Modulus 251
 - Shear Load Coefficient-CSA 522
 - Shear Walls 289, 320-321
 - Shortcut Keys 12
 - Shortcut Menu 7
 - Sigma1, Sigma2 (principal stresses) 313
 - Single Angle 282
 - Single Angles 181, 190
 - Single Solution 348
 - Size Factor- CSA 523
 - Size Factor (Wood) 520
 - Skyline Solver 348
 - Slaved Joints 214
 - Slenderness Factor 523
 - Snap Points 144
 - Solution 347
 - Batch 348
 - Envelope 348
 - Preferences 69, 122
 - Single 348
 - Solve Menu 6
 - Sorting 5, 332, 355
 - Span 42, 125
 - Spectra 107
 - Add or Edit 105
 - ASCE 104
 - IBC 104
 - NBC 105
 - Plotting 106-107
 - Procedure 100
 - UBC 104
 - Splitting Members 261
 - Spreadsheets 351
 - Copying 354, 356
 - Defaults 356
 - Editing 353-354
 - Filling 353
 - Finding 355
 - Inserting 354
 - Math 353
 - Moving 351
 - Sorting 355
 - Wall Panels 377
 - Spreadsheets Menu 6
 - Springs 25
 - Boundary Conditions 25
 - SRSS 101, 223
 - Stability 358
 - Stability Factors (Wood) 520
 - Standard Combinations 225
 - Standard Skyline Solver 348
 - Standard Solver 349
 - Static Base Shear 103
 - Static Solution 347
 - Status Bar 13
 - Stiffness Matrix 25, 265, 276
-

Stiffness Reduction 20, 178
Story Drift. See Drift 82
Story Forces / Moments 316, 321
Straps 394, 469
Suggested Shapes 79
Sway
 Concrete 45
Sway Flags 371
System Factor 523
System Requirements 1

T

T Shapes 18
Tank Generation 118
Tapered Member Results 207
Tapered Members 191
Tapered Wide Flange 171
 Database 171
 Limitations 180
Technical Support 541
Tee Shapes 171, 180
Temperature 209, 230, 249
Temperature Factor (Wood) 520
Tension only members 265
Tension only springs 26
Thermal Coefficient 252
Thermal Loads 249
Thick Plates 309
Tiling 15
Toggle Buttons 129
Toolbars 7
Tools Menu 6
Tooltips 168
Top of Member 274
Transient Loads 224-225

Translucent Display 132-133
Transverse Shear 309
Trim/Extend Members 152
Tripartite Plot 106
Troubleshooting 509
 Dynamics 98
 Error Messages 530
 P-Delta 296
 Warning Log 509
Truss Connections 272
Truss Generation 116
Tube Shape 29
Tube shapes 170
Tutorial 1, 168
Two Dimensional Models 25

U

UBC 104, 225
Ultimate Stress 252
Unbraced Lengths 363
 Concrete 43
Undo 5, 141, 352
Unequal Flanges 171, 180
Units 372
Unity Check (UC) Results 195

V

Vertical Axis 89, 94
Vibrations 95
View menu 5
View mode 15
Viewer Mode 164
Volume Factor 520
Von Mises Stress 313

W

Wall Force Results 391
Wall Opening Headers 394, 469
Wall Panel Editor 379
Wall Panel Joints 377
Wall Panel Labels 377
Wall Panel Spreadsheets 377
Wall Panel Thickness 377
Wall Panel View Controls 382
Wall Panels 374
Wall Panels - Results 391
Walls 320, 374
 Design Forces 321
 Dynamics 98
 Modeling 320
 Penetrations 323
Warning Log 509
Warnings 509
Web Site 168
Wet Service Factor (Wood) 520
White Background 138
Wind ASIF 123
Window Selections 158
Window Tiling 15
Window Toolbar 7
Windows 14
Wood Database Limitations 512
Wood Design 516
 Adjustment Factors 519
 Design Code 124
 GluLams 516
 Limitations 523
 Messages 526
 Parameters 518

Shapes 510

Wood View Controls 468
Wood Wall - Design 404, 468, 487
Wood Wall - Suggested Design 483
Wood Wall Detail Reports 493
Wood Wall Results 406, 491
Work Vectors 95
WT Shapes 171

X

X-axis rotation 263
X-Braces 214

Y

Y-Top/Y-Bot (bending stress) 280
Yield Stress 75, 252
Young's Modulus 251

Z

Z-Top/Z-Bot (bending stress) 280
Z shapes 17-18
Zooming 11, 128
ZS Shapes 29
ZU Shapes 29