



ADAPT-FELT 2017

USER MANUAL

Copyright 2017

LIST OF CONTENTS

1. DESCRIPTION OF THE PROGRAM	3
1.1 GENERAL.....	5
1.2 SCOPE AND LIMITATIONS.....	5
2. USER'S MANUAL	11
2.1 GENERAL.....	13
2.2 ADAPT-FELT MAIN SCREEN.....	13
2.3 HOW TO GENERATE OR EDIT DATA	15
2.3.1 Title Input Screen.....	17
2.3.2 Geometry Input Screen	17
2.3.3 Material Properties Input Screen.....	20
2.3.4 Friction Loss Input Screen.....	21
2.3.5 Long-term Loss Input Screen.....	22
2.4 PROGRAM EXECUTION	24
2.5 HOW TO VIEW, PRINT AND SAVE THE RESULTS	24
2.5.1 The Tabulated Report	24
2.5.2 Individual Graphs	25
2.5.3 The Summary Report.....	26
2.6 TENDON LIBRARIES AND DEFAULT SETTINGS	27
3. DESCRIPTION OF REPORT	29
3.1 INTRODUCTION	31
3.2 GENERAL INFORMATION.....	31
3.3 DETAILED STRESS VALUES	35
3.4 DETAILED TENDON ELEVATION.....	36
3.5 DETAILED POLYLINE DATA	36
3.6 SUMMARY PRINTOUT	37
4. THEORY	41
4.1 INTRODUCTION	43
4.2 FRICTION LOSS CALCULATIONS.....	50
4.3 LONG-TERM STRESS LOSSES.....	52
4.3.1 Elastic Shortening of Concrete (ES)	52
A. For members with unbonded tendons.....	52
B. For members with bonded tendons.....	53
4.3.2 Creep of Concrete (CR)	53
A. For members with unbonded tendons.....	53
B. For members with bonded tendons.....	54
4.3.3 Shrinkage of Concrete (SH).....	54
4.3.4 Relaxation of Tendon (RE).....	54

5. EXAMPLES	57
5.1 EXAMPLES IN AMERICAN STANDARD UNITS.....	59
5.1.1 Box Girder Bridge Example - Grouted Tendon.....	59
5.1.2 Beam Example from ADAPT Post-tensioning Software.....	64
5.1.3 Circular Water Tank Example - General Profile	69
5.2 EXAMPLES IN SI UNITS	75
5.2.1 Box Girder Bridge Example - Grouted Tendon.....	75
5.2.2 Beam Example From Adapt Post-Tensioning Software	79
5.2.3 Circular Water Tank Example - General Profile	83
6. VERIFICATION AND ADDITIONAL EXAMPLES.....	89
6.1 VERIFICATION OF FRICTION LOSS CALCULATIONS.....	91
6.2 LONG-TERM LOSS COMPUTATIONS FOR UNBONDED TENDONS.....	96
6.3 LONG-TERM LOSS CALCULATIONS FOR GROUTED TENDONS.....	99
6.3.1 Calculation of Initial Stress in Tendon	101
6.3.2 Bending Moments and Stresses at Required Points	101
6.3.3 Calculation of Long-term Stress Losses	103
A. At mid-span	103
B. At second support.....	105
6.4 LONG-TERM STRESS LOSS CALCULATIONS FOR A PRECAST BEAM .	112
6.5 LONG-TERM STRESS LOSS FOR A PRECAST PILE.....	117
7. APPENDIX A	121
A.1 EXCERPT FROM ADAPT PRINTOUT.....	123
A.2 NOTATION.....	124
A.3 REFERENCES	126

Chapter 1

DESCRIPTION OF THE PROGRAM

1.1 GENERAL.....5
1.2 SCOPE AND LIMITATIONS.....5

This Page Left Intentionally

BLANK

1.1 GENERAL

This Section describes the scope and limitations of the program. The background to the computations is discussed in Chapter 3.

1.2 SCOPE AND LIMITATIONS

ADAPT-FELT is written to handle two essentially independent sources of stress loss in prestressed tendons, namely the long-term and immediate losses. The long-term stress losses considered are those due to the elastic shortening, creep and shrinkage of concrete, and stress relaxation in prestressing steel. The immediate losses are due to friction and anchoring of tendons.

ADAPT-FELT handles the immediate and long-term loss computations separately. Thus the program may be used to calculate long-term losses without a friction loss analysis. Likewise, friction calculations may be performed without determining long-term losses. In the latter case, a user-defined lump sum long-term stress loss may be combined with the friction loss calculations as a user option. In the general case, however, a computer run consists of a friction loss in combination with a long-term stress loss calculation.

The output of the program consists of (i) reflection of input data, (ii) a listing of the long-term stress loss constituents and their sum, and (iii) the distribution of stress immediately before and after tensioning and seating of tendons, (iv) location and magnitude of maximum stress, (v) elongations of the tendon at jacking locations, (vi) a graphical summary of the analysis, including tendon stresses along the length, tendon profile and other data.

Friction losses are due to length of tendon and angular changes in its geometry. A continuous tendon of a complex geometry must be subdivided into spans, or segments each having a geometry definable through the tendon profile library of ADAPT-FELT. Alternatively, a tendon may be defined by an adequate number of coordinates along its path.

The current library of tendon profiles of ADAPT-FELT consists of six most commonly used tendon geometries each for supported spans and cantilevers. In addition, a general shape tendon profile is supplied to *approximate* unusual shapes, such as tendons occupying a three dimensional space, or circular water tanks. The most common tendon geometry types are shown in **Figures 1.2-1** through **1.2-3**. The geometry of a common tendon is defined by its type and the horizontal and vertical locations of its control points. The *approximated* general

tendon shape (type 4) is specified by its length and total change of angle between its two ends. Thus an extensive variety of profiles may be generated by the user. For example, the reversed parabola designated as tendon type 1 in **Figure 1.2-1(a)** can also describe a simple parabola, or a simple parabola for a part of the span and a reversed parabola for the remainder of the span.

Internally, the program calculates the stresses at 21 points along the length of each tendon profile listed in its library. Each tendon profile from the library typically represents a span of the structure. Only the computation outcome for three points is listed in the summary output of results. The locations of these points for each tendon profile type are shown in **Figures 1.2-1** and **1.2-2**. For the general tendon, the stresses at tendon ends and its mid-length are calculated and printed out. The change of angle between the ends and the mid-length is assumed to be one half of the total angle change specified by the user.

The detailed listing of tendon stresses in each span is appended to the end of the report together with a detailed listing of tendon heights along each span. The tendon stresses and tendon profile may also be viewed graphically and printed.

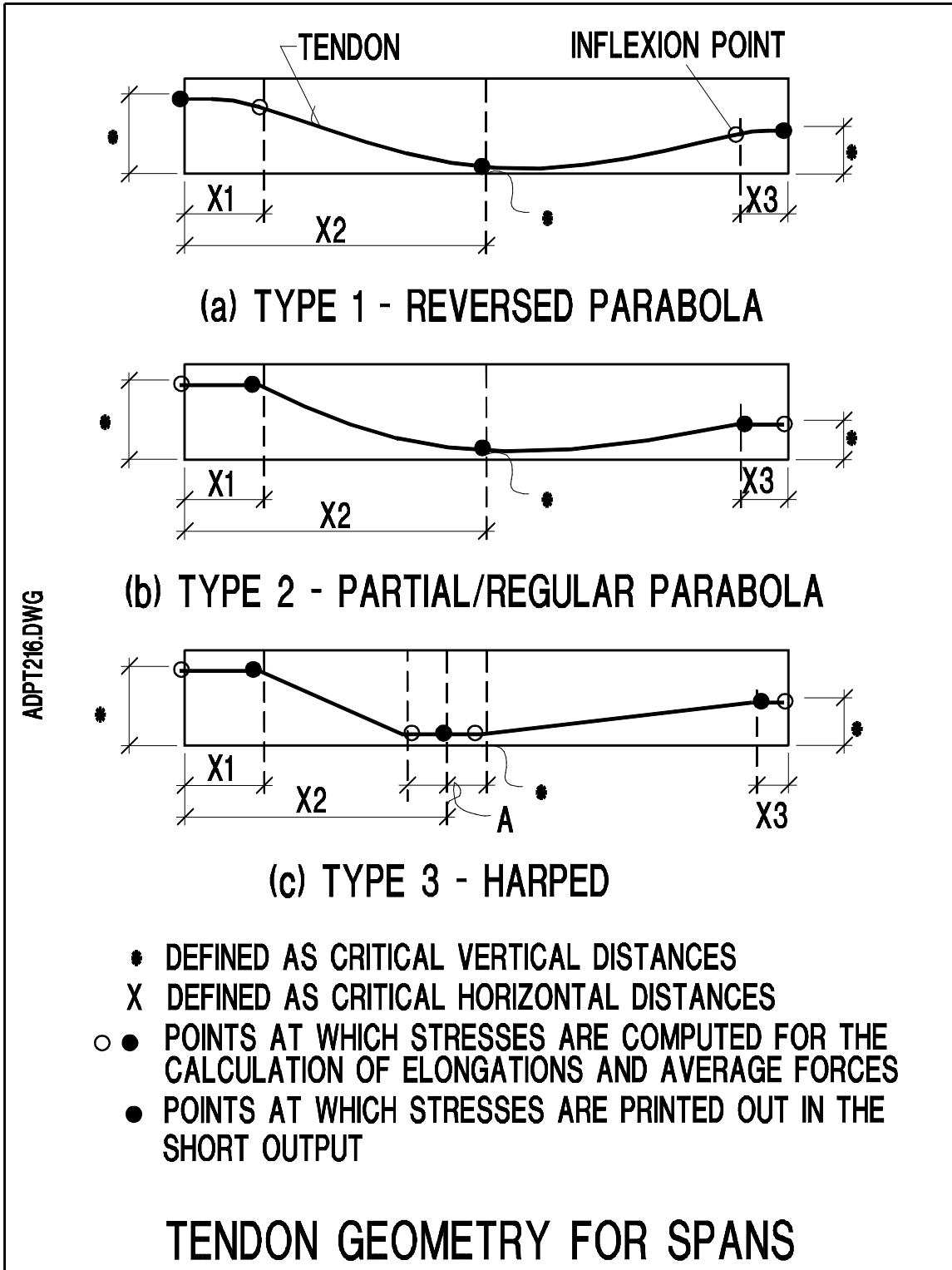

FIGURE 1.2-1

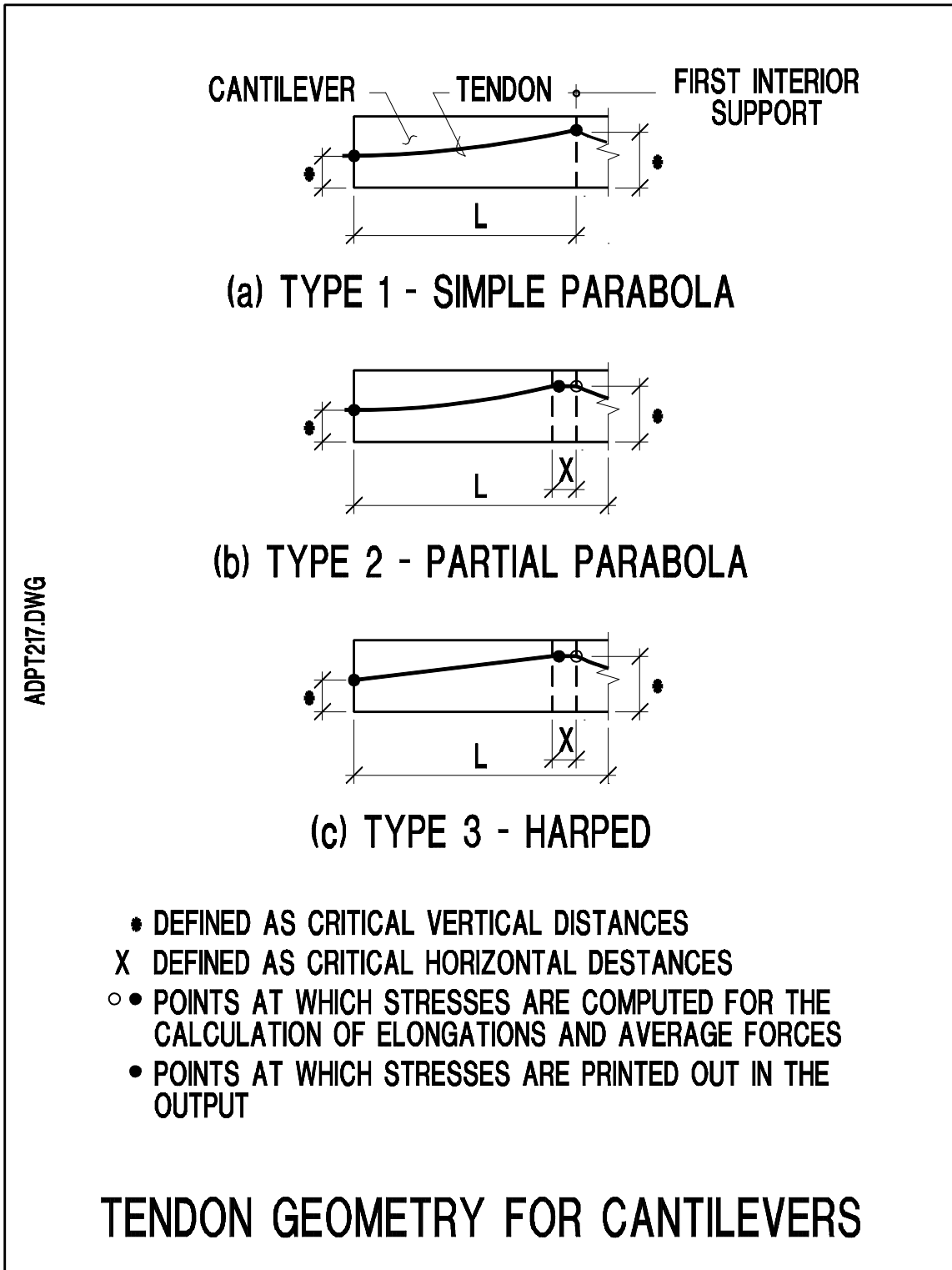

FIGURE 1.2-2

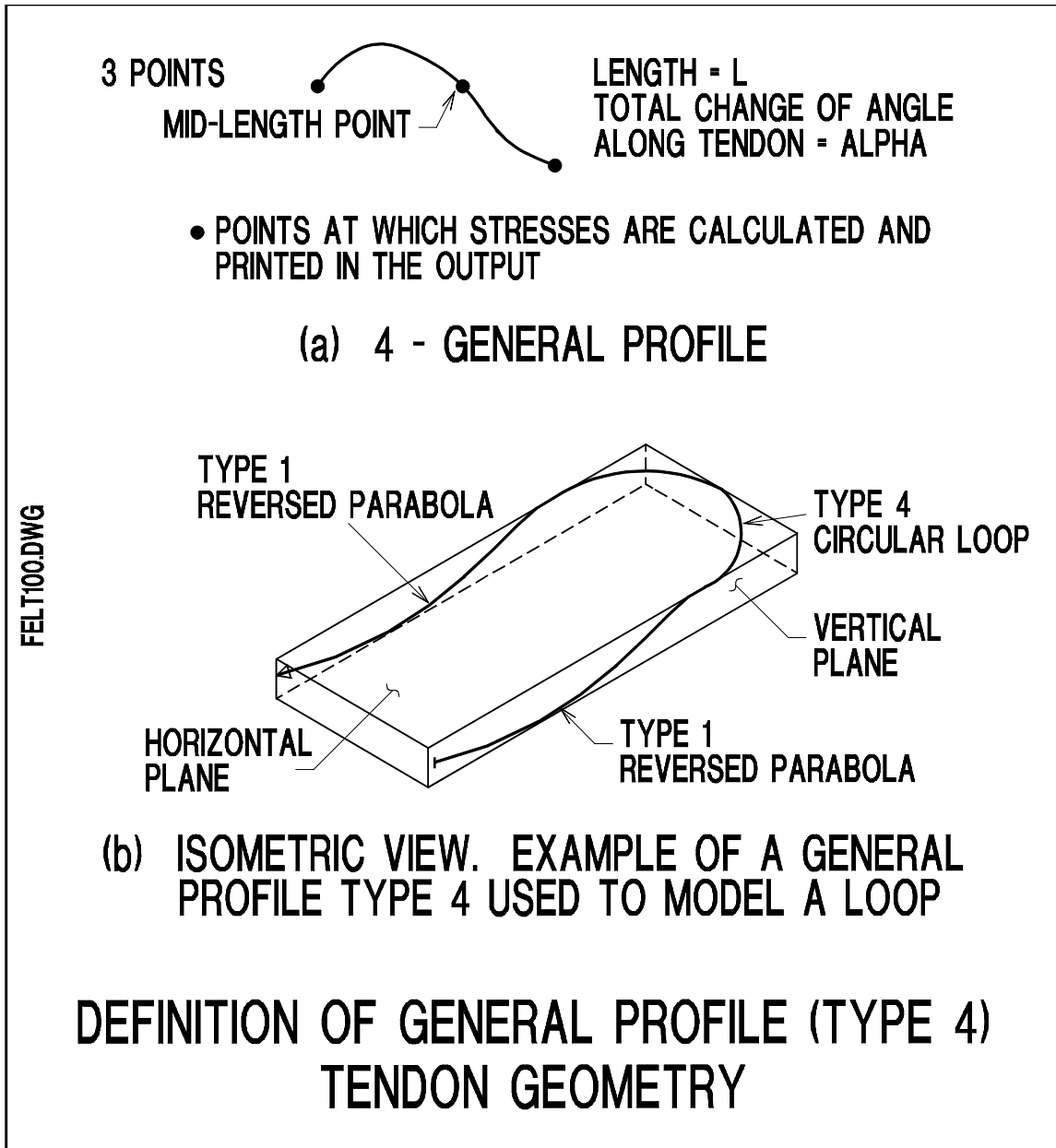

FIGURE 1.2-3

This Page Left Intentionally

BLANK

Chapter 2

USER'S MANUAL

2.1	GENERAL.....	13
2.2	ADAPT-FELT MAIN SCREEN.....	13
2.3	HOW TO GENERATE OR EDIT DATA.....	15
2.3.1	Title Input Screen.....	17
2.3.2	Geometry Input Screen.....	17
2.3.3	Material Properties Input Screen.....	20
2.3.4	Friction Loss Input Screen.....	21
2.3.5	Long-term Loss Input Screen.....	22
2.4	PROGRAM EXECUTION.....	24
2.5	HOW TO VIEW, PRINT AND SAVE THE RESULTS.....	24
2.5.1	The Tabulated Report.....	24
2.5.2	Individual Graphs.....	25
2.5.3	The Summary Report.....	26
2.6	TENDON LIBRARIES AND DEFAULT SETTINGS.....	27

This Page Left Intentionally

BLANK

2.1 GENERAL

This section describes how to prepare input data, execute the program, view the output and, if required, print the results. The scope of the program is given in Chapter 1; the background to ADAPT-FELT's algorithm is described in Chapter 3. For the description of output refer to Chapter 4.

2.2 ADAPT-FELT MAIN SCREEN

All program functions are controlled from the ADAPT-FELT main program window, using the menus provided. The ADAPT-FELT main window menu bar is shown in **Figure 2.2-1**.

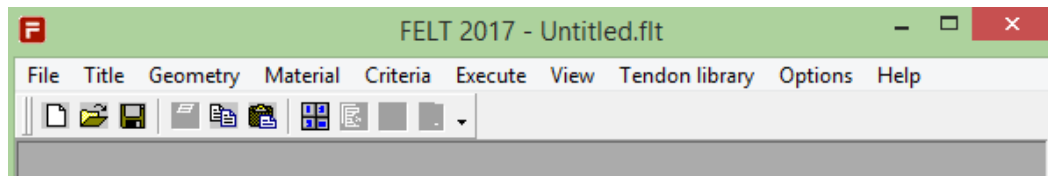





FIGURE 2.2-1

All options that can be accessed by the main program menus are listed below. For the commands that might be activated using the toolbar, the appropriate icon is displayed next to the feature.

File Menu

New. 	Starts a new project.
Open. 	Opens an existing project.
Save. 	Saves input file under a user-specified file name.
Export Graph.	Allows the user to export the currently active graph as either a bitmap (.BMP) or a Windows metafile (.WMF).
Page Setup.	Sets the paper size, report margins, paper orientation and printer.

Print.  Prints the currently active report or graph window.

Exit. Closes all windows and exits the program.

Title

Opens a dialog box where general project information can be set.

Geometry

Opens a dialog box where tendon geometry is entered.

Material

Opens a dialog box where prestressing material properties can be set.

Criteria

Friction Loss Parameters. Opens a dialog box where friction loss parameters can be set.

Long-Term Loss Parameters. Opens a dialog box where log-term loss parameters can be set.

Execute

Executes the program calculations.

View menu

View Full Report .  Opens detailed report.

View Summary Report.  Opens the Summary Report.

View Stress Loss Graph.  Opens the stress loss graph .

View Tendon Elevation.  Opens the tendon elevation graph.

Tendon Library

Allows you to open and edit common tendon shapes.

Options

Report Heading.	Opens a dialog box which allows the report header to be edited.
Report Setup.	Opens a dialog box where the report content can be set.
Report Font.	Opens a dialog box where the report font can be set.
Graph Settings.	Configures the graphs generated by the program. Options include whether to include X and Y gridlines, min/max data points and a legend.

Help

About ADAPT.	Company address, phone, fax and e-mail information.
About ADAPT-FELT.	Program information.
Technical Support.	Information on how to obtain program support.
Disclaimer.	Defines responsibility of the software user.

2.3 HOW TO GENERATE OR EDIT DATA

Input data is generated or edited using a series of input screens accessible from the main window. The input screens are activated in several ways. If a model is being input for the first time, the input screens are activated by clicking on the *New* item of the main menu. This opens up the *Title* input screen (**Fig. 2.3-1**). Alternatively, the user may click on the *Title* menu item. If an existing model is to be edited, the user should open the desired file from the main menu and proceed with the new run. The rest of the input functions are described below in relation to data generated for a beam shown in **Figure 2.3-1**.

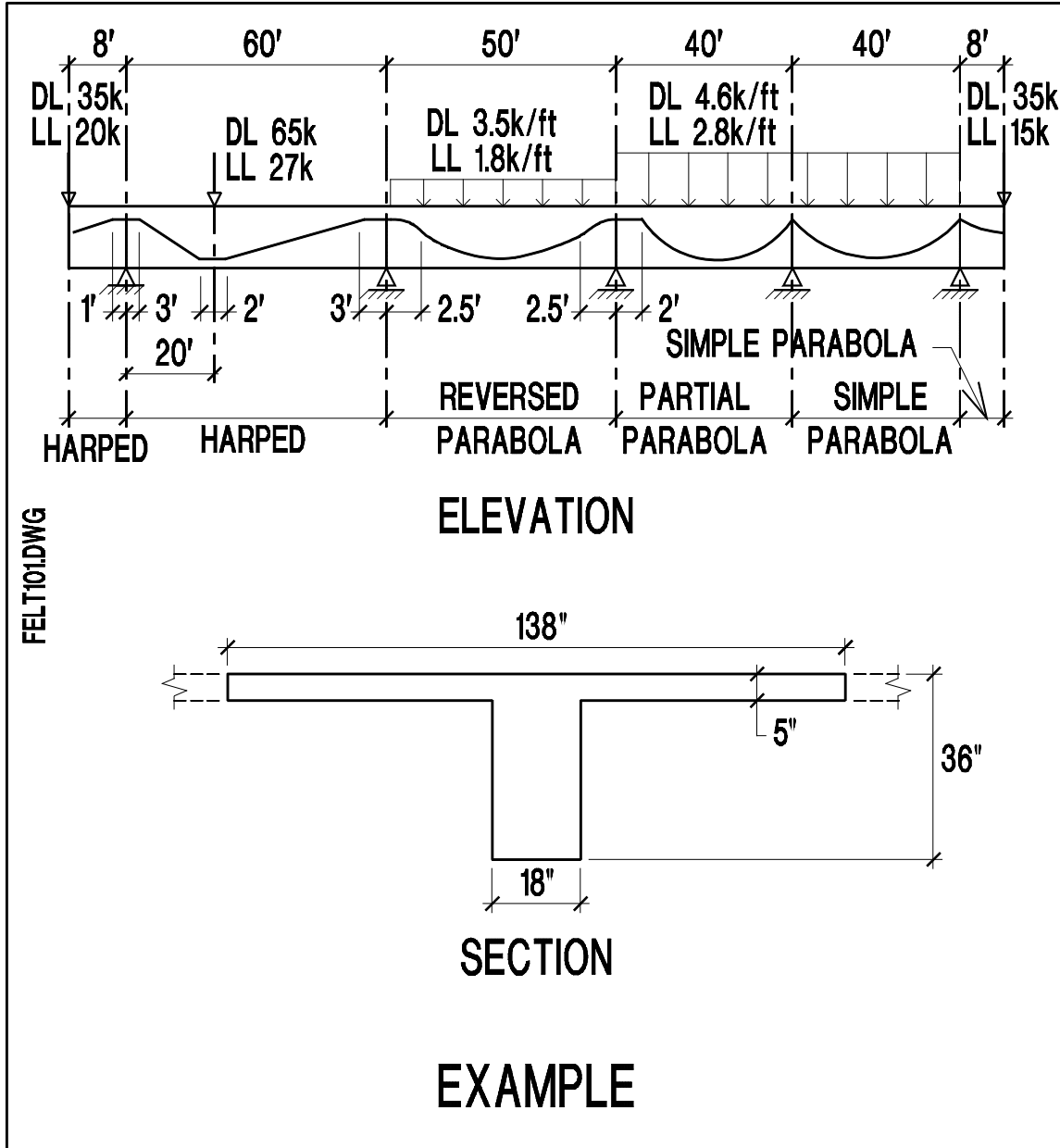
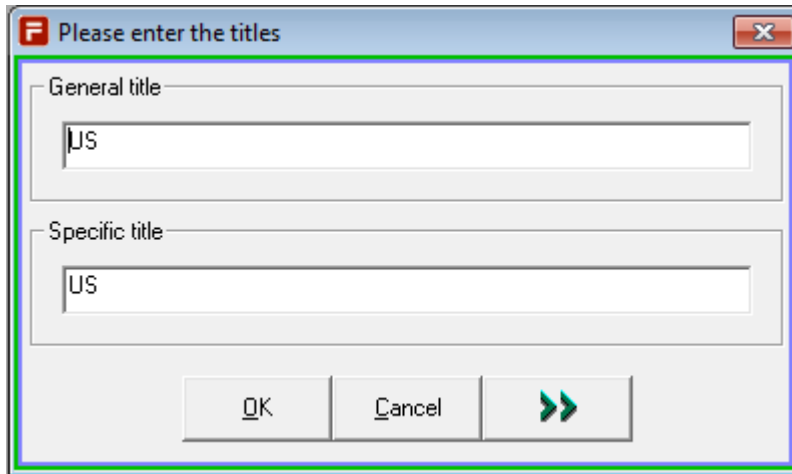

FIGURE 2.3-1

Beside the *Title* input screen, other input screens used to generate a model are shown in **Figures 2.3-2** through **2.3-11**. Using the arrow buttons at the bottom of each screen, the user may browse through the entire set of input data. Through a number of checks incorporated into the program, inconsistent entries will be detected at the time of input and denied acceptance by the editor. Data fields which are not applicable to the particular problem being entered will be “grayed out” during data preparation. The following is the detailed description of each input screen.

2.3.1 Title Input Screen

The *Title* window automatically opens when a new project is started or an existing project is opened. This screen is also available through menu option *Title*. The *General title* and *Specific title* of the project will appear at the first page of the report.



The image shows a dialog box titled "Please enter the titles". It has a standard Windows-style title bar with a red icon on the left and a close button on the right. The dialog contains two text input fields. The first field is labeled "General title" and contains the text "US". The second field is labeled "Specific title" and also contains the text "US". At the bottom of the dialog, there are three buttons: "OK", "Cancel", and a green double arrow button pointing to the right.

FIGURE 2.3-2 TITLE INPUT SCREEN

2.3.2 Geometry Input Screen

Information on tendon shape, span length, vertical and horizontal distances to critical points of tendon geometry are contained in *Geometry* input screen (**Fig. 2.3-3**).

One line is assigned to each span or cantilever. Data fields of the first line are devoted to the typical parameters. Any value entered on this line will result in the same value being applied to all spans. Using the arrow keys on the keyboard or the mouse, the user may roam over the data fields, enter or update values at random.

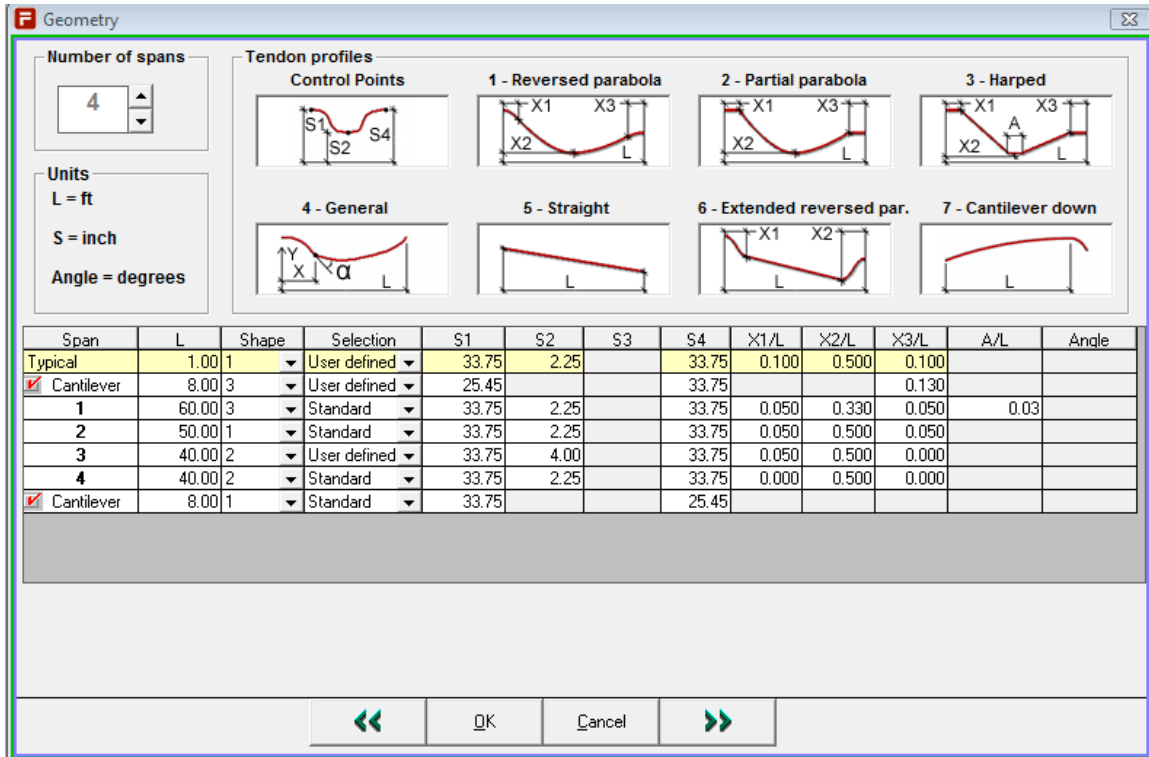

FIGURE 2.3-3 GEOMETRY INPUT SCREEN

Other details of the screen are as follows:

- Cantilevers are specified by clicking on the appropriate check box.
- The tendon shape input choices (1-7) are illustrated by the diagrams at the top of the screen.
- The *Selection* column allows the user to select from the library of predefined parameters for selected shape or to input “user-defined” set of parameters in the columns that follow. The library of predefined tendon shapes is set up by the user and is available for all ADAPT-FELT runs. The setup is described later in this section.
- The *General* input selection (shape 4) allows the user to input a series of coordinate points and angle changes to model tendons with irregular geometries, such as in special structures. The procedure is as follows:
 - Set shape to 4 for desired span.
 - Set *Selection* to *User defined*. The *General Shape Entry* options will appear at the bottom of the screen (Fig.2.3-4).

- Select one option and double click on the cell in the *Selection* column to open data entry table. (see **Fig. 2.3-4**).

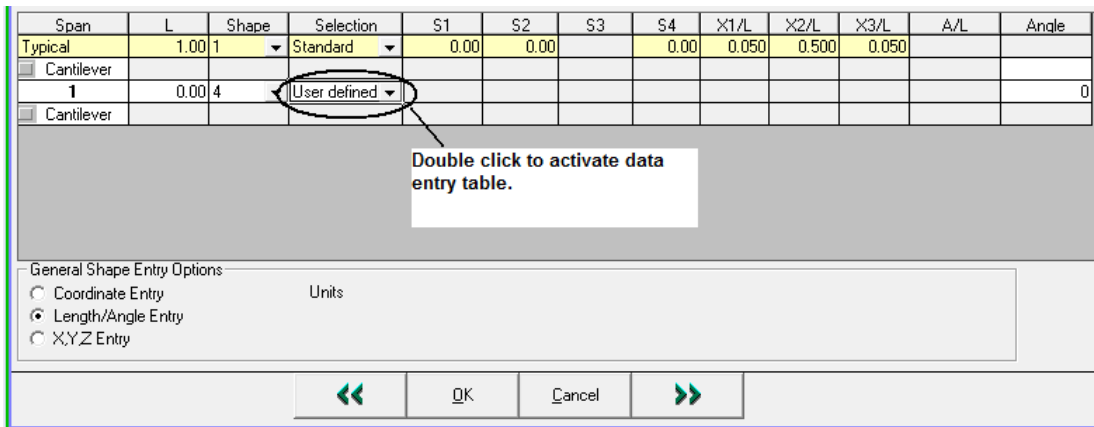

FIGURE 2.3-4 GEOMETRY INPUT SCREEN FOR GENERAL TENDON SHAPE

- Fill in the data in one of the input tables (**Fig. 2.3-5** through **2.3-7**) and click OK to save data and close input table. The total tendon length and angle will display in the geometry window.

There are three types of input tables:

1. *Coordinate Entry* - this type of input table enables the user to enter X and Y coordinates of tendon points, and out of plane angle in ZAngle column. Based on this entry the program calculates segment length, angle change, total length and total angle. Total angle is the sum of angle calculated based on X, Y coordinates and angle specified in ZAngle column.

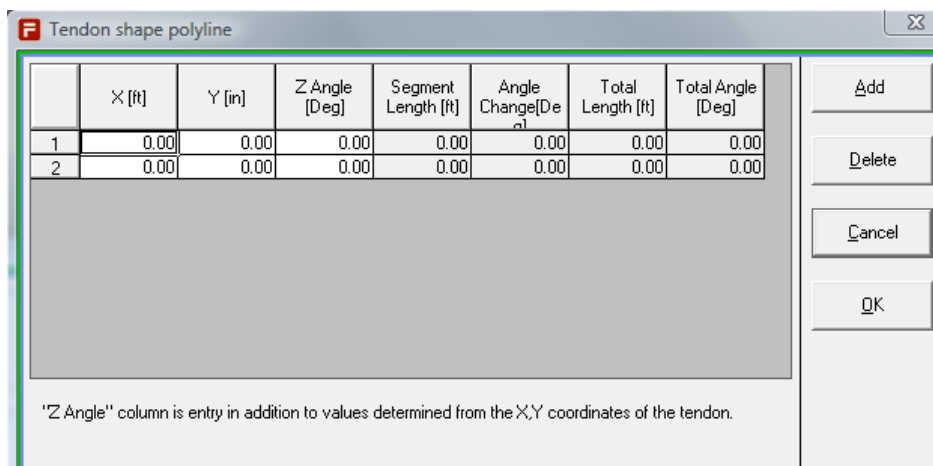

FIGURE 2.3-5 COORDINATE ENTRY TABLE

2. *Length/Angle Entry* – this input table enables the user to define length and angle change for each segment of a tendon. The angle change is sum of in-plane and out-of-plane angle. The program calculates total length and total angle change.

	Segment Length [ft]	Angle Change [Deg]	Total Length [ft]	Total Angle [Deg]
1	0.00	0.00	0.00	0.00

FIGURE 2.3-6 LENGTH/ANGLE ENTRY TABLE

3. *X,Y,Z Entry* – this input table enables the user to define tendon by X,Y,Z coordinates of its points. The program calculates segment length, angle change, total length and total angle.

	X [ft]	Y [in]	Z [ft]	Segment Length [ft]	Angle Change [Deg]	Total Length [ft]	Total Angle [Deg]
1	0.00	0.00	0.00	0.00	0.00	0.00	0.00
2	0.00	0.00	0.00	0.00	0.00	0.00	0.00

FIGURE 2.3-7 X,Y,Z ENTRY TABLE

2.3.3 Material Properties Input Screen

The material properties and system parameters of the prestressing/post-tensioning system are input using this screen (**Fig. 2.3-8**). The screen input is self-explanatory. Note, however, that the selection made in the screen will affect what parameters can be input in the next screen. For example, if “pretensioned” is selected than no friction losses will be calculated and long-term losses will be based upon bonded system.

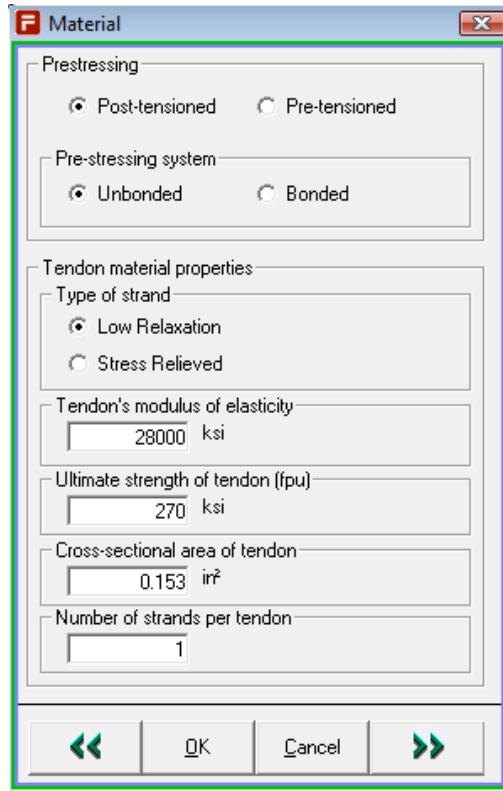

The image shows a software dialog box titled "Material". It contains several sections for inputting prestressing data:

- Prestressing:** Radio buttons for "Post-tensioned" (selected) and "Pre-tensioned".
- Pre-stressing system:** Radio buttons for "Unbonded" (selected) and "Bonded".
- Tendon material properties:**
 - Type of strand:** Radio buttons for "Low Relaxation" (selected) and "Stress Relieved".
 - Tendon's modulus of elasticity:** Text input field with "28000" and "ksi".
 - Ultimate strength of tendon (fpu):** Text input field with "270" and "ksi".
 - Cross-sectional area of tendon:** Text input field with "0.153" and "in²".
 - Number of strands per tendon:** Text input field with "1".

At the bottom of the dialog box are four buttons: a left-pointing double arrow, "OK", "Cancel", and a right-pointing double arrow.

FIGURE 2.3-8 MATERIAL INPUT SCREEN

2.3.4 Friction Loss Input Screen

Data related to calculation of friction losses are input in this screen (Fig. 2.3-9). The user may designate the first (left) end and/or the last (right) end as stressing end. Note that if both ends are designated as stressing ends, the program assumes that the tendon is stressed and locked off at the left end first, followed by a second pull at the right end.

The screenshot shows a dialog box titled "Friction Loss Parameters" with a red 'F' icon and a close button. It contains several input fields and checkboxes:

- Perform friction loss calculation:** Radio buttons for "Yes" (selected) and "No".
- Friction coefficients:**
 - Angular coefficient of friction (Mu):** Input field with "0.07" and "per rad".
 - Wobble coefficient of friction (K):** Input field with "0.0014" and "per ft".
- Stressing:** A group box containing:
 - Stressing ends:** Checkboxes for "Left end" and "Right end", both checked.
- Anchor-set:** Input field with "0.25" and "in".
- Ratio of jacking stress to ultimate strength:** Input field with "0.8".

At the bottom, there are four buttons: a left arrow, "OK", "Cancel", and a right arrow.

FIGURE 2.3-9 FRICTION LOSS INPUT SCREEN

2.3.5 Long-term Loss Input Screen

The long-term loss input parameters are input in this screen (**Fig. 2.3-10**). The user has the option to specify a lump sum loss value or allowing the program to calculate losses based on the input data. If the system is bonded or pretensioned (as opposed to post-tensioned), an additional screen will open containing the long-term loss parameters specific to that kind of system (**Fig. 2.3-11**). The input screen for long-term loss parameter of bonded system includes an explanation of each parameter at the bottom of the screen.

New to ADAPT-FELT 2017 the Long-term Loss Input Screen also includes the option of reporting minimum stress and force for the modeled system. When this option is selected as YES, the program will report the minimum initial stress, final minimum stress after losses and the final minimum force in addition to the respective average stresses and forces.

Long-term Loss Parameters

Calculation of long-term losses
 Yes No

Report Minimum Stress and Force
 Yes No

Enter lump sum losses
 Yes No
 Lump sum long-term loss: psi

Environment
 Relative humidity: %
 Volume to surface ratio: in

Long-term loss parameters
 Average initial precompression: psi
 Concrete's ultimate strength (f'c at 28 days): psi
 Concrete's modulus of elasticity (28 days): ksi
 Age of concrete at stressing: days
 Concrete's modulus of elasticity at stressing: ksi
 Concrete weight:
 Normal Semi-lightweight
 Lightweight

<< OK Cancel

FIGURE 2.3-10 LONG-TERM LOSS INPUT SCREEN

Bonded system long-term loss parameters

Concrete stress (fcp) due to Ppi: psi

Concrete stress due to DL at stressing (fg): psi

Concrete stress (fcds) due to superimposed DL: psi

Stress in strand at release (fpi): ksi

Explanation:

FIGURE 2.3-11 ADDITIONAL LONG-TERM LOSS INPUT SCREEN FOR BONDED AND PRE-TENSIONED TENDONS

2.4 PROGRAM EXECUTION

To execute the program, click on the *Execute* menu item, or  tool. After the calculations are completed, the user may see results in graphical or tabular formats.

2.5 HOW TO VIEW, PRINT AND SAVE THE RESULTS

2.5.1 The Tabulated Report

The results may be viewed in both tabulated and graphical formats. Each format may be selected from *View* menu, or by clicking on  tool. The view of the tabulated report shows the detailed results of the friction and long-term loss calculations, including listing of tendon stresses and tendon height at 1/20th points in each span. This report can also be printed by clicking on the print button or by selecting *Print* from the *File* menu. The tabulated report information is also included in the Summary Report.

The user can select the content of the report through *Report Setup* dialog window available in *Option->Report Setup*.

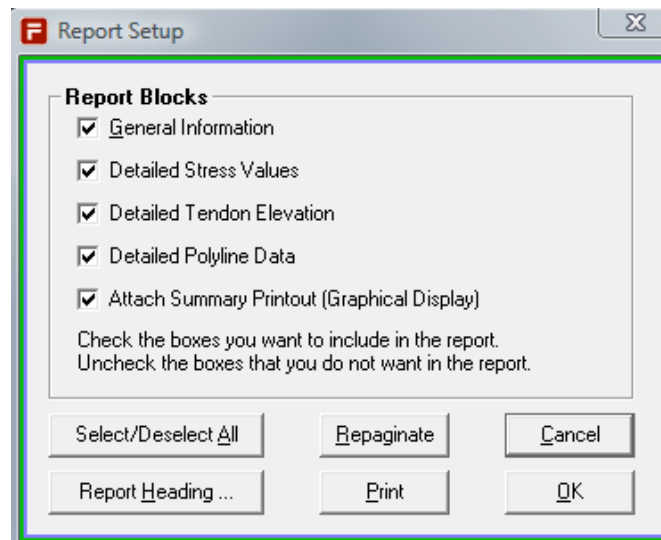



FIGURE 2.5-1 REPORT SETUP SCREEN

By default the report includes all data blocks. To change the report content check/uncheck appropriate boxes and click *Repaginate* button. The program will then regenerate a new, updated report.

Also, the user has option to change report font and header using the appropriate items from the *Options* menu.

2.5.2 Individual Graphs

The individual graphs of tendon stress after friction and long-term losses and of the tendon profile can also be viewed on screen by selecting the appropriate item from the *View* menu, or by clicking on  tool. Each graph may be printed in the same manner as the tabulated report. Also, the graph view may be exported as .BMP (bitmap) or .WMF (windows metafile) files. To export a graph, select *Export Graph* from the *File* menu or right click in the area of the graph and select *Export Dialog* option.

The program allows the user to set the variety of different graph plotting options (**Fig. 2.5-2**). These options are available through right mouse click when the cursor is over area of the graph.

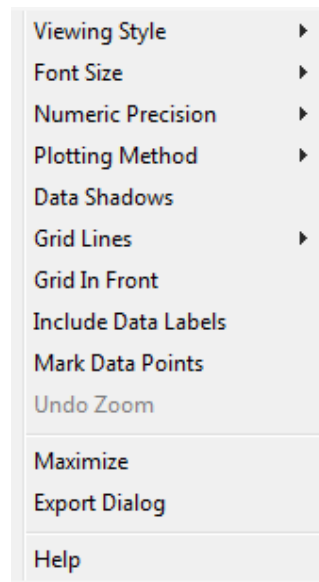

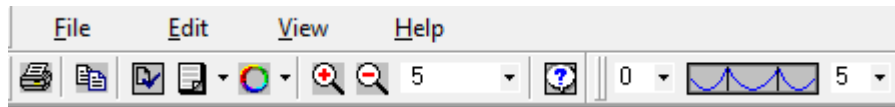

FIGURE 2.5-2 GRAPH PLOTTING OPTIONS

Also, the *Graph Settings* item of the *Options* menu allows the user to modify features to be shown on the graph, such as gridlines, legends and minima/maxima.

2.5.3 The Summary Report

The *Summary report* (**Fig. 2.5-3**), which contains the graphs and a summary of the tabulated input, may also be generated using the *View* menu, or by clicking on  tool. The summary report view contains another set of action buttons and menus to manipulate the view, printing and contents of the report.



Specific details are as follows:

- *File* menu items control the report margins and printing functions.
- The *Edit* menu allows the user to copy the report to clipboard where it can be pasted into another program as a bitmap image.
- *View* menu items allows the user to zoom in or out, specify portrait/landscape, specify color/monochrome, as well as select the contents of the report and add design comments at the bottom of the report.
- The *Help* menu provides details of each data block available in the report.

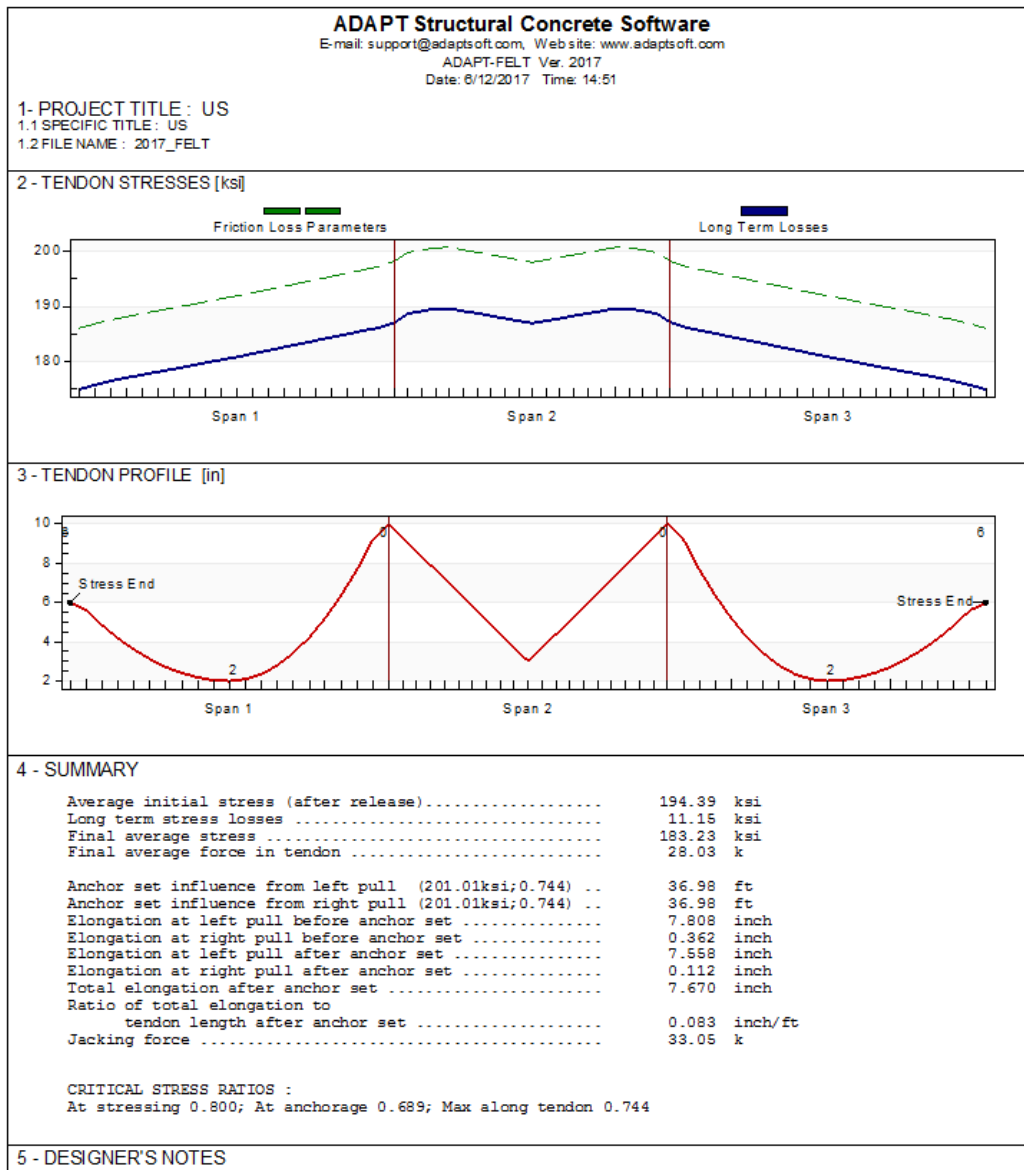

FIGURE 2.5-3 SUMMARY REPORT

2.6 TENDON LIBRARIES AND DEFAULT SETTINGS

The ADAPT-FELT program now offers the user the opportunity to create a series of tendon profile libraries for those cases that appear again and again in a project. After creating these libraries the tendon shape definitions can be entered into the *Geometry* input screen with a single mouse click.

To make tendon libraries available for repeated runs they must be first saved into the three template files used to generate new ADAPT-FELT runs (US.flt, SI.flt

and MKS.flt – each file represents a different system of units). One of these files is used to create a new untitled input file whenever the *New* item of the *File* menu is selected. To generate libraries of tendon shape parameters use the following procedure:

1. Open the appropriate template file for your system of units (US.flt for American units, SI.flt for SI units and MKS.flt for MKS units).
2. From the *Tendon Library* menu click on one of the tendon shapes listed. An input window will open with a “standard” tendon profile defined (**Fig. 2.6-1**). You can add, delete, rename or modify shapes. When finished apply changes and close the window.

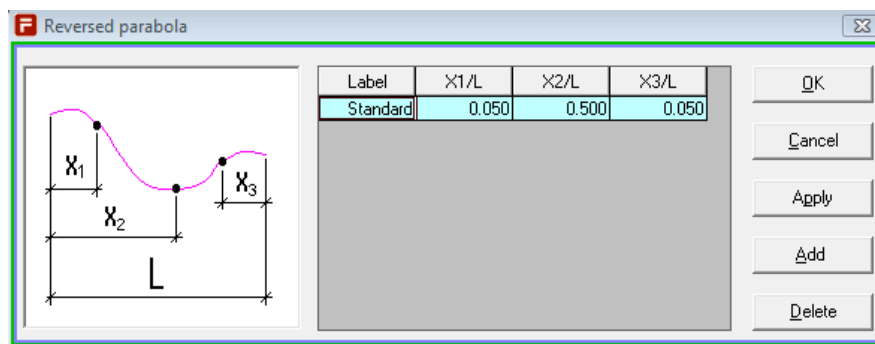

FIGURE 2.6-1 TENDON LIBRARY

3. Repeat the last step for each type of tendon as needed.
4. When done, save the file. Now, when new files are generated in the corresponding units the tendon libraries are available for input into the model. The new tendons are listed under the “selection” column of the geometry input and may be input with a single mouse click.

Note: other default values may also be modified and resaved in the template files to create a unique set of initial values.

Chapter 3

DESCRIPTION OF REPORT

3.1	INTRODUCTION	31
3.2	GENARAL INFORMATION.....	31
3.3	DETAILED STRESS VALUES	35
3.4	DETAILED TENDON ELEVATION	36
3.5	DETAILED POLYLINE DATA	36
3.6	SUMMARY PRINTOUT	37

This Page Left Intentionally

BLANK

3.1 INTRODUCTION

This section describes the printout of ADAPT-FELT. A typical printout is shown in the following pages. This printout is for the example illustrated in **Figure 2.3-1** and described in detail in Chapter 2.

The report may include the following data blocks:

- General Information
- Detailed stress values
- Detailed tendon elevation
- Detailed polyline data
- Summary printout

The following is detailed description of each data block.

3.2 GENERAL INFORMATION

General Information data block includes:

- Header - The uppermost portion of the figure is the identification block prepared by the user. It normally bears the user's name, address and affiliation. The lower half of this block shows the program's version and update information.
- Date and time - The date and time of the execution of the program is printed below the title block. This information is extracted by the program from the computer's internal clock and calendar.
- Project title – This is the mirror image of the text in *General title* field of the *Title* input screen.
- Specific title - This is the mirror image of the text in *Specific title* field of the *Title* input screen.
- Long-term loss calculation results - The printout of the long-term stress losses is subdivided into the information inputted by the user and the values calculated by ADAPT-FELT.
- Friction and elongation calculations results - The friction loss calculations are reported in the second half of the printout. The data block entitled "INPUT PARAMETERS" is a mirror reflection of user's input. The user's input is followed by a table, "TENDON ID, GEOMETRY AND STRESS

PROFILE”, consisting of each span's tendon type (column 3), heights at critical points (columns 4 through 6) and horizontal distance ratios of the tendon (columns 7 through 9). The calculated distribution of stress is printed under columns 10 through 12.

Refer to the SUMMARY compilation for elongation information and maximum stresses. Maximum stresses are given in parentheses on the lines giving the anchor set influences from the left and right. These are the stresses at locations XL and XR (see **Figure 4.1-1(f)**).

The critical stress summary consists of ratios of the actual stresses to the strand's specified ultimate strength. These are the values which should be compared with ACI's maximum permissible ratios.

```

-----
|                               ADAPT CORPORATION                               |
|       1733 Woodside Road, Suite 220, Redwood City, CA 94061 USA       |
|           Tel: (650) 306 2400, Fax: (650) 306 2401                     |
|       E-mail: support@adaptsoft.com,  Web site: www.adaptsoft.com      |
-----
|                               ADAPT-FELT Standard 2017                     |
|       ADAPT POST-TENSIONING STRESS LOSS & ELONGATION PROGRAM           |
|       This program calculates the long-term and immediate stress losses  |
|       in a post-tensioned tendon. It outputs the elongations at the     |
|       stressing ends and the final stress profile along the tendon.     |
-----
DATE: Jun 12, 2017                                           TIME: 14:56:02

PROJECT TITLE :
US

SPECIFIC TITLE :
US

LONG - TERM LOSS CALCULATIONS :

INPUT PARAMETERS :
Post-tensioning system ..... UNBONDED
Type of strand ..... LOW LAX
Ultimate strength of strand ..... 270.00 ksi
Modulus of elasticity of strand ..... 28000.00 ksi
Estimate of initial average compression ..... 150.00 psi

Concrete strength at 28 days ..... 4000.00 psi
Average weight of concrete ..... NORMAL
Estimated age of concrete at stressing ..... 5 days
Modulus of elasticity of concrete at stressing ..... 1523.00 ksi
Modulus of elasticity of concrete at 28 days ..... 3604.00 ksi
Estimate of average relative humidity ..... 80. %
Volume to surface ratio of member ..... 0.00 in
    
```

FIGURE 3.2-1 (CONT'D...)

F R I C T I O N & E L O N G A T I O N C A L C U L A T I O N S :

INPUT PARAMETERS :

```

Coefficient of angular friction (meu)..... 0.07000 /radian
Coefficient of wobble friction (K)..... 0.00140 rad/ft
Ultimate strength of strand ..... 270.00 ksi
Ratio of jacking stress to strand's ultimate strength 0.80
Anchor set ..... 0.25 inch
Cross-sectional area of strand ..... 0.153 inch^2
Total Number of Strands per Tendon..... 1
STRESSING ..... AT BOTH ENDS
    
```

LEGEND :

```

P ..... = Tendon profile type defined as: 1=reversed parabola;
          2=partial/regular parabola; 3=harped; 4=general; 5=straight;
          6=extended reversed parabola; 7=cantilever down
X1/L etc = horizontal distances to control points in geometry of the
          tendon divided by span length
Stresses tabulated are after anchor set but before long-term losses.
    
```

TENDON ID, GEOMETRY AND STRESS PROFILE (2017_FELT)

SPAN	ft	P	< TENDON HEIGHT in.>			Horizontal ratios			<- STRESS (ksi) -->													
			start	center	right	X1/L	X2/L	X3/L	start	center	right											
-1	----	2	----	3	----	4	----	5	----	6	----	7	----	8	----	9	----	10	----	11	----	12
1	32.00	1	6.00	2.00	10.00	0.05	0.50	0.05	186.03	191.94	198.28											
2	28.02	4	(angle changes = 4.8)						198.28	198.11	198.28											
3	32.00	1	10.00	2.00	6.00	0.05	0.50	0.05	198.28	191.94	186.03											
-----												92.06 ft (total length of tendon)										

SUMMARY :

```

Average initial stress (after release)..... 194.39 ksi
Long term stress losses ..... 11.15 ksi
Final average stress ..... 183.23 ksi
Final average force in tendon ..... 28.03 k

Minimum initial stress (after release)..... 186.03 ksi
Long term stress losses ..... 11.15 ksi
Final minimum stress ..... 174.87 ksi
Final minimum force in tendon ..... 26.76 k

Anchor set influence from left pull (201.01ksi;0.744) .. 36.98 ft
Anchor set influence from right pull (201.01ksi;0.744) .. 36.98 ft
Elongation at left pull before anchor set ..... 7.808 inch
Elongation at right pull before anchor set ..... 0.362 inch
Elongation at left pull after anchor set ..... 7.558 inch
Elongation at right pull after anchor set ..... 0.112 inch
Total elongation after anchor set ..... 7.670 inch
Ratio of total elongation to
  tendon length after anchor set ..... 0.083 inch/ft
Jacking force ..... 33.05 k
    
```

(CONT'D...) FIGURE 3.2-1

3.3 DETAILED STRESS VALUES

This data blocks includes printout of stresses at 1/20th point along each span and cantilever (**Fig. 3.3-1**).

CRITICAL STRESS RATIOS :

At stressing 0.800; At anchorage 0.689; Max along tendon 0.744

DETAIL OF STRESSES AT 1/20TH POINTS ALONG EACH SPAN

Units are in ksi

X/L	Span 1	Span 2	Span 3
0.00	186.03	198.28	198.28
0.05	186.82	199.86	197.29
0.10	187.58	200.31	196.70
0.15	188.13	200.77	196.11
0.20	188.68	200.81	195.51
0.25	189.23	200.35	194.91
0.30	189.77	199.90	194.32
0.35	190.31	199.45	193.71
0.40	190.86	199.00	193.11
0.45	191.40	198.56	192.51
0.50	191.94	198.11	191.94
0.55	192.51	198.56	191.40
0.60	193.11	199.00	190.86
0.65	193.71	199.45	190.31
0.70	194.32	199.90	189.77
0.75	194.91	200.35	189.23
0.80	195.51	200.81	188.68
0.85	196.11	200.77	188.13
0.90	196.70	200.31	187.58
0.95	197.29	199.86	186.82
1.00	198.28	198.28	186.03

FIGURE 3.3-1

3.4 DETAILED TENDON ELEVATION

This data block includes printout of tendon heights at 1/20th point along each span and cantilever (**Fig. 3.4-1**)

TENDON HEIGHT AT 1/20TH POINTS ALONG EACH SPAN

Units are in inch

X/L	Span 1	Span 2	Span 3
0.00	6.00	10.00	10.00
0.05	5.60	9.30	9.20
0.10	4.84	8.60	7.69
0.15	4.18	7.90	6.36
0.20	3.60	7.20	5.20
0.25	3.11	6.50	4.22
0.30	2.71	5.80	3.42
0.35	2.40	5.10	2.80
0.40	2.18	4.40	2.36
0.45	2.04	3.70	2.09
0.50	2.00	3.00	2.00
0.55	2.09	3.70	2.04
0.60	2.36	4.40	2.18
0.65	2.80	5.10	2.40
0.70	3.42	5.80	2.71
0.75	4.22	6.50	3.11
0.80	5.20	7.20	3.60
0.85	6.36	7.90	4.18
0.90	7.69	8.60	4.84
0.95	9.20	9.30	5.60
1.00	10.00	10.00	6.00

FIGURE 3.4-1

3.5 DETAILED POLYLINE DATA

In the case when tendon profile is defined using General (shape 4) input the tendon geometry is described in this data block. An example is shown in figure below:

DETAILED POLYLINE INFORMATION					
SPAN	LENGTH (ft)	TYPE	X (ft)	Y (in.)	Z (ft)
2	28.02	4	0.00	10.00	0.00
			2.00	9.00	0.00
			4.00	8.00	0.00
			6.00	7.00	0.00
			8.00	6.00	0.00
			10.00	5.00	0.00
			12.00	4.00	0.00
			14.00	3.00	0.00
			16.00	4.00	0.00
			18.00	5.00	0.00
			20.00	6.00	0.00
			22.00	7.00	0.00
			24.00	8.00	0.00
			26.00	9.00	0.00
			28.00	10.00	0.00

FIGURE 3.5-1

3.6 SUMMARY REPORT

The user has an option to produce a *Summary report*. This includes the summary page shown in **Fig. 3.6-1** and the detailed report output previously described. The summary report is described in Section 2.5.3.

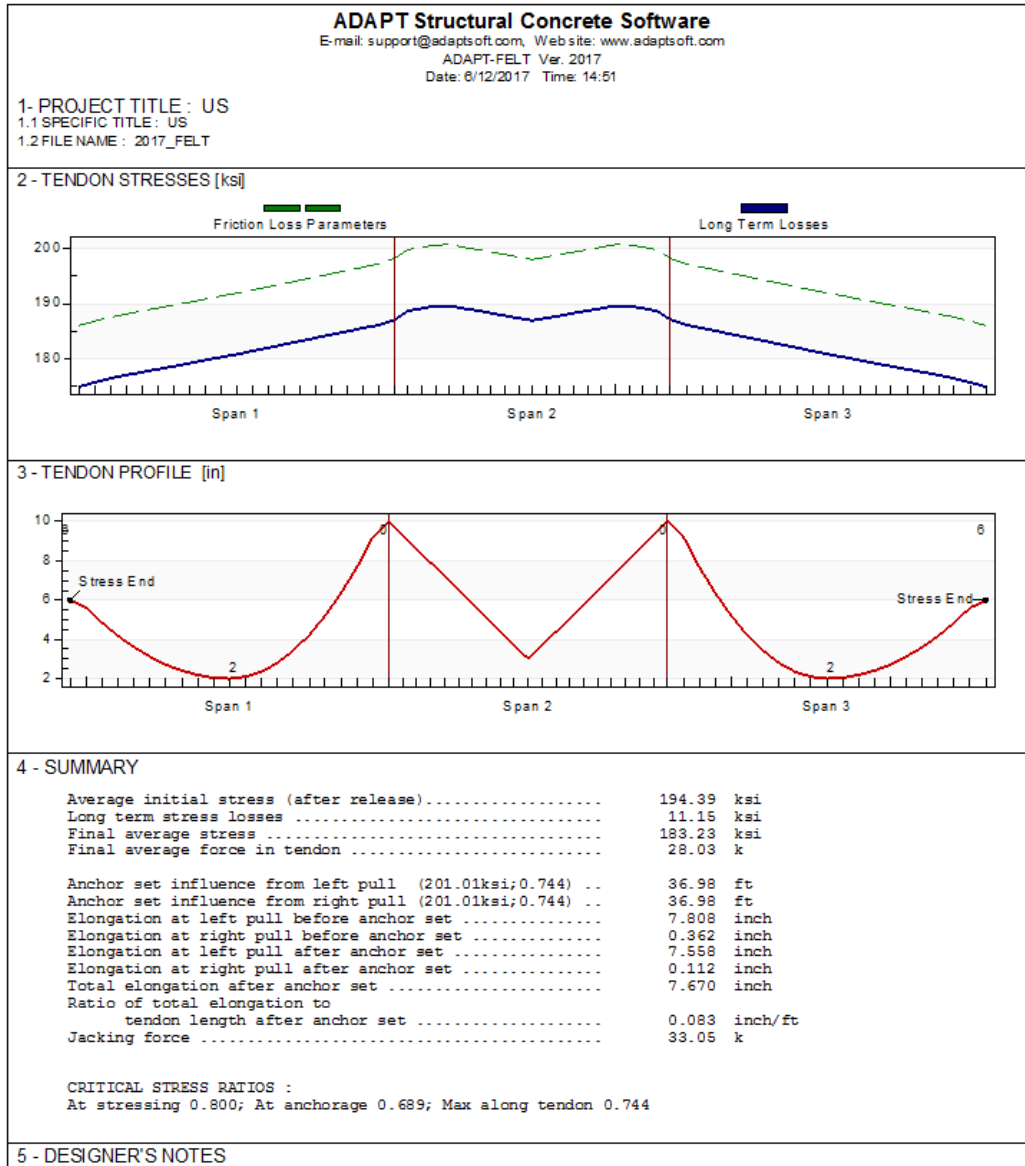

FIGURE 3.6-1

This Page Left Intentionally

BLANK

Chapter 4

THEORY

4.1	INTRODUCTION	43
4.2	FRICTION LOSS CALCULATIONS	50
4.3	LONG-TERM STRESS LOSSES.....	52
4.3.1	Elastic Shortening of Concrete (ES)	52
	A. For members with unbonded tendons.....	52
	B. For members with bonded tendons.....	53
4.3.2	Creep of Concrete (CR)	53
	A. For members with unbonded tendons.....	53
	B. For members with bonded tendons.....	54
4.3.3	Shrinkage of Concrete (SH).....	54
4.3.4	Relaxation of Tendon (RE).....	54

This Page Left Intentionally

BLANK

4.1 INTRODUCTION

Stresses induced in a prestressing strand are not normally constant along its length, and do not remain unchanged with time. The principal factors affecting the distribution of stress along a strand are: (i) friction losses at time of stressing, (ii) retraction of strand as it seats and locks into the anchorage device, (iii) shrinkage of concrete, (iv) elastic shortening of concrete, (v) creep of concrete, and (vi) relaxation of stress in strand's initial prestressing. These factors result in a reduction of stress along the length of a strand.

Other factors such as changes in temperature and flexing of the structure under loading also affect the stresses in a strand, but these do not necessarily result in a permanent lowering of stress level and are not categorized as stress losses.

For typical commercial structures using unbonded low relaxation tendons, the total loss in prestressing is typically 10 to 15 percent of the initial values. A lump sum stress loss assumption of 30 ksi was for several years the prevailing practice. The advent of new low relaxation strands and results of new studies prompted the rejection of *lump sum* stress allowances. Now, based on ACI 318R-1983 a detailed stress calculation is required. The following is a quotation from section 18.6 of this code:

Lump sum values of prestress losses for both pre-tensioned and post tensioned members which were indicated in previous editions of the (ACI) commentary are considered obsolete. Reasonably accurate estimates of prestress losses can be easily calculated in accordance with recommendations in Reference 18.6 which include considerations of initial stress level ($0.70f_{pu}$ or higher), type of steel . . .

Reference 18.6 recommended in the preceding quotation forms the underlying procedures of ADAPT-FELT.

The research on friction losses and the background to the proposed procedures for their calculations are reported in numerous publications such as those given in the attached list of references.

A rigorous evaluation of stress losses is both time consuming and complex. It is not warranted to undertake a laborious calculation for each tendon on a routine basis, especially as studies indicate that for slabs and beams common to residential and commercial buildings, reliable solutions can be obtained with a number of simplifying assumptions. PTI NEWSLETTER, dated January, 1982, reports a parametric study conducted by Gregory P. Chacos for common commercial buildings and recommends values for typical cases.

In addition to the standard stress loss factors, prestressing in a member may be affected by its connections to other structural members which restrain its movement. These factors are beyond the scope of the present work, but should be taken into account based on rational procedures which consider equilibrium of forces and strain compatibility. Aalami and Barth (1987) reported on the consequences of constraints in commercial buildings.

The stress losses due to friction and seating of a tendon, calculated in ADAPT-FELT, are based on ACI (318-83). The long-term losses follow the results of a study initiated by ACI/ASCE committee 423, directed by Paul Zia and reported in Concrete International (June 1979). It is assumed that the contribution of various factors affecting the stress losses, such as friction, creep and shrinkage are independent from one another. Hence, the loss due to each factor may be computed separately. The total stress loss in a tendon is the sum of individually calculated losses.

The stress losses in a tendon are grouped into immediate and long-term losses.

The immediate losses are (i) friction and (ii) anchorage seating loss.

The long-term losses are due to (i) shrinkage of concrete, (ii) the elastic shortening of concrete, (iii) creep of concrete, and (iv) the relaxation creep in the strands.

The stress losses along a tendon are illustrated in **Figure 4.1-1**. **Figure 4.1-1(a)** is a beam with a continuous tendon to be stressed at both ends. It is assumed that the left end is pulled first, followed by stressing at the right end.

Figure 4.1-1(b) shows the distribution of stress along the strand at maximum pull and prior to locking the strand off. The jacking stress is commonly specified at $0.85f_{pu}$, where f_{pu} is the ultimate strength of the strand. The smooth curve is a simplification of the actual distribution for illustration purposes. The actual shape of the curve is determined by the geometry of the strand and friction parameters.

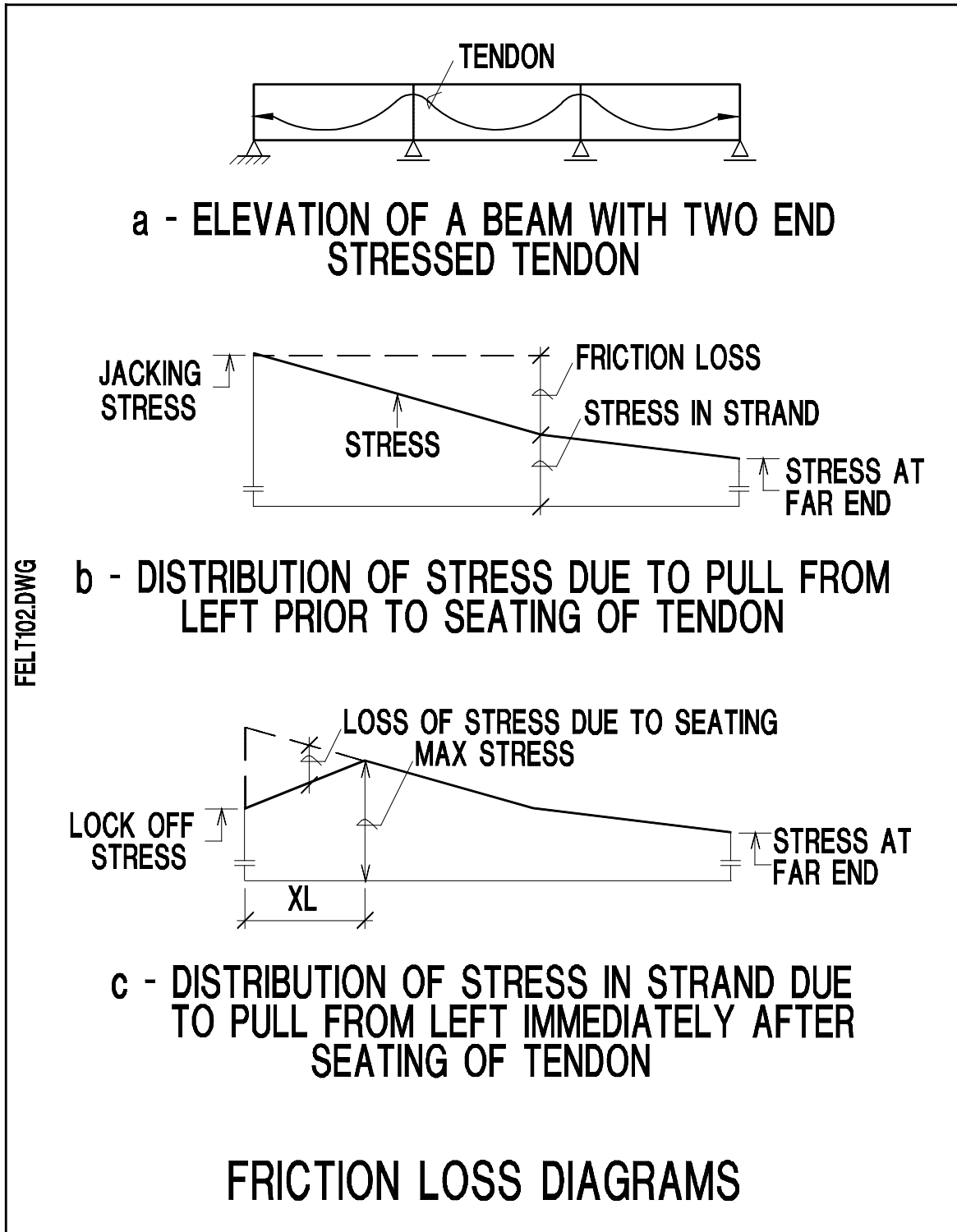
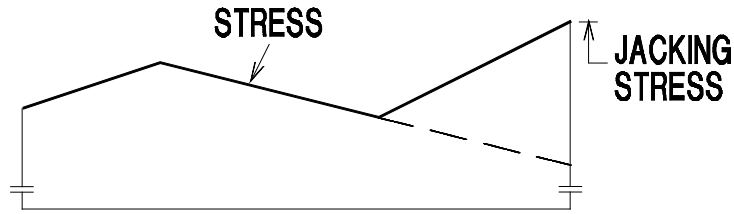
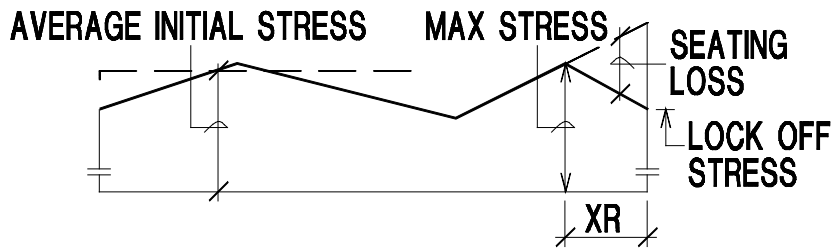

FIGURE 4.1-1 (CONT'D...)

FELT103.DWG



d - STRESS IN STRAND DUE TO PULL FROM RIGHT PRIOR TO SEATING OF TENDON



e - STRESS IN STRAND IMMEDIATELY AFTER SEATING OF TENDON AT THE RIGHT END

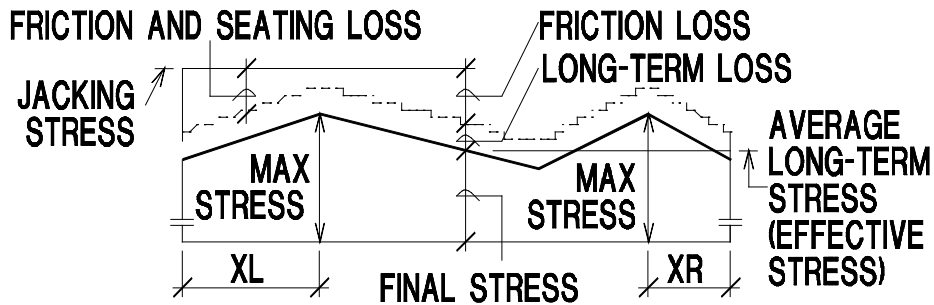

f - DISTRIBUTION OF FINAL STRESS IN STRAND AFTER IMMEDIATE AND LONG-TERM LOSSES

FRICION & LONG TERM STRESS LOSS DIAGRAMS

(CONT'D...) FIGURE 4.1-1

Figure 4.1-1(c) is the distribution after the strand is locked off at the left end of the beam. Observe that the initial stress generated in the strand is partially lost over a length of strand marked XL. This is the result of the retraction of the strand at the stressing end while the wedges are being locked. The maximum stress occurs at XL. The maximum permissible value of this stress immediately after lock off is recommended as $0.74f_{pu}$ by ACI (18.5.1-b). The permissible stress at anchorage immediately after seating of strand is limited to $0.7f_{pu}$ (ACI 18.5.1.c). The movement of the wedges necessary to lock a strand is typically 0.25 to 0.40 inches. Stressing rams with power seating capability reduce the seating loss to a minimum. For short strands, and/or larger values of seating loss the length XL may extend to the far end of the strand. The reduced portion of the stress diagram XL, at any point along its length, has the same gradient as the original pre-lock off curve, but with a reversed sign.

The jacking of the tendon at the right end raises the stresses at this end over a range which extends in most cases to approximately one-half the length of tendon. Refer to **Figure 4.1-1(d)**.

The distribution of stress immediately after the strand is seated at the right is shown in **Figure 4.1-1(e)**. The lock off stresses at left and right are not generally the same even for the same values of seating loss (wedge pull-in), unless the tendon is symmetrical about its mid-length. A second peak results in the stress diagram which is designated as the max stress in the diagram. The *average initial stress* is the average of the stress distribution. This value is used by some design engineers in the computation of the stresses in unbonded post-tensioned structures at *transfer of post-tensioning*. Transfer of post-tensioning refers to the loading condition immediately after the completion of stressing; prior to the application of live loading and influences of long-term stress losses.

With the lapse of time and the precipitation of long-term stress losses, the stress in a strand is reduced along its length. **Figure 4.1-1(f)** shows a schematic of a stress distribution after all losses have taken place. In relation to the final distribution of stress the following remarks are noteworthy.

The long-term stress loss along a tendon is not constant, since even under uniform geometry and exposure conditions, differences in concrete stress along a strand result in non-uniform losses. However, it is common practice with most consulting engineers that in design of commercial buildings a representative long-term loss value is calculated and used for the entire member. In the calculation of the representative stress loss the local concrete stress is substituted by the average concrete stress along the length of member.

Long-Term stress losses are obviously a function of time. The relationships employed in this work refer to a time at which over 90 percent of the losses have taken place. For common commercial buildings this period is between 2 and 2.5

years. The stress loss rates for shrinkage, creep and relaxation are not the same. But, as a first approximation for estimating the combined stress losses for shorter concrete ages, the curve shown in **Figure 4.1-2** may be utilized. This diagram is compiled from the combined effects of shrinkage and creep using data from the PCI Design Handbook.

Many consulting engineers debate that the stress diagram computed from the friction formulas and shown in the **Figure 4.1-1** is based on the maximum possible stress gradient attainable from the friction coefficients. For unbonded strands, flexing of the member due to the application of loading or temperature changes can only affect a reduction of stress gradient at a point, since the diagram is originally constructed with the maximum gradient at all points. This phenomenon results in a flattening of the stress diagram toward a more uniform stress distribution along its length. There are no conclusive experimental studies known to the author, based on which the extent of the stress redistribution toward a uniform average stress could be quantified. Based on the foregoing rationale, and the complexity of an alternative approach, an *effective stress* is calculated for the unbonded strands and used by most consultants in the design of commercial buildings. The effective stress is the average initial stress (**Figure 4.1-1(e)**) minus a representative long-term stress loss value for the entire member. The effective stress is also referred to as *design stress* by some engineers.

PTI holds that until research conclusively reveals whether or not, and to what extent, stress redistribution occurs in unbonded tendons, designers should base their computations on stresses derived from friction diagrams (PTI NEWSLETTER) as shown in **Figure 4.1-1(f)**. A paper from University of Texas at Austin (Burns et al. 1991) concludes that in unbonded tendons, the distribution of stresses does not significantly equalize with time.

At the structural calculation stage, and for those engineers who employ a *generic design* approach (for description refer to ADAPT design manual chapter 4), the outcome of the design is an *effective force* to be provided by post-tensioning. The effective force is the item which is reported on the structural drawings and in the calculations. The distribution of stress is not a priori information. The question of whether the effective force is based on *averaged* stresses, local stress, or other considerations is not applicable in this design approach.

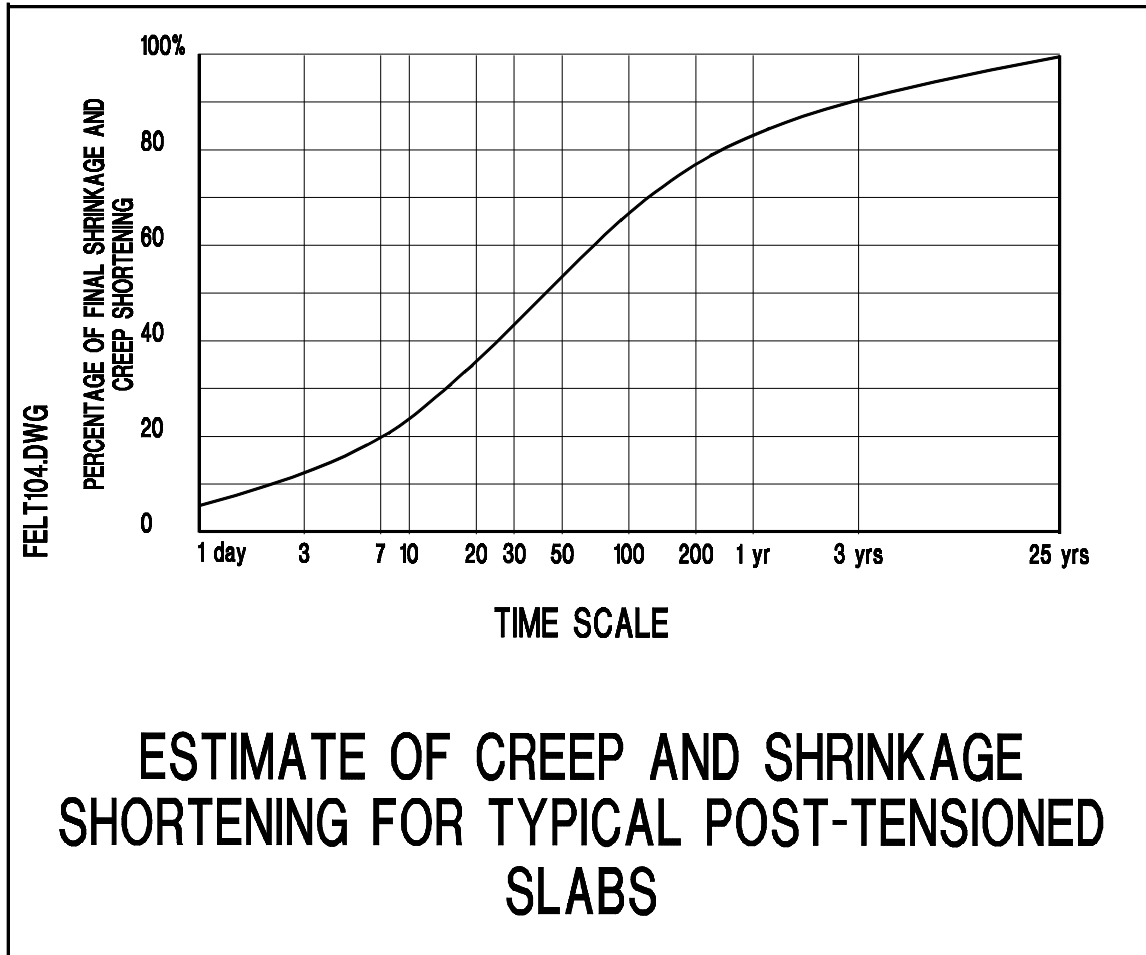

FIGURE 4.1-2

It is at the shop drawing preparation phase that the effective forces must be substituted by *number of strands*. It is evident that at this stage the *actual stresses* at each location must be used to arrive at the required number of strands at that location.

When the structural design follows a *system bound* approach (refer to ADAPT manual Chapter 4), that is to say, the structural calculations are preceded by a friction and long-term loss computation using parameters particular to a post-tensioning supplier, the structural calculations conclude with the number and location of strands. In this case the question of *design stress* is of prime importance to the structural designer. At this time the ACI code is specific. The stresses used in structural computations should be derived with due considerations to immediate and long-term losses. No explicit recognition is given for the redistribution of stresses in unbonded systems.

Unless satisfactory evidence is provided, the use of an effective stress does not seem justifiable in a *system bound* design approach.

4.2 FRICTION LOSS CALCULATIONS

The stress at any point along a strand is related to the jacking stress through the following relationships:

$$P_s = P_x * e^{(\mu * \alpha + K * X)}$$

where,

- K = wobble coefficient of friction expressed per unit length of strand;
- P_s = stress at jacking point
- P_x = stress at distance x from the jacking point;
- X = distance from the stressing point;
- α = change of angle in strand (radians) from the stressing point to distance X;
- μ = coefficient of angular friction;
- * = multiplication symbol.

The friction coefficients for the common strands and materials are given in **Table 4.2-1**. As new ducts and coating materials become available consult the supplier for the friction coefficients to be used in final design.

The stress loss due to seating the strand is calculated from the following relationship:

$$a = (1/E_s) * \int (\text{final stress} - \text{initial stress}) * dx$$

where,

- a = anchor set
- E_s = modulus of elasticity of tendon

The integral is carried out over the range XL or XR (**Fig. 4.1-1**). It may be interpreted as: area intercepted between the pre-seating and post-seating stress diagrams divided by the modulus of elasticity of strand equals to wedge pull-in. (**Fig. 4.2-1**)

Starting from the stressing end, stresses are calculated at 21 points in each span along the length of tendon. The locations at which stresses are calculated are shown in **Figures 1.2-1** and **1.2-2**. For example, for a reversed parabola, the stresses are calculated at five points: at the start, at first inflexion point, at mid-span, at second inflexion point, and at the end. The distribution between the selected points is approximated by a straight line.

TABLE 4.2-1 FRICTION COEFFICIENTS FOR POST-TENSIONING TENDONS - From PTI Manual (4th edition)

a - RANGE OF VALUES		
Type of Tendon 1	Wobble coefficient K (per ft) 2	Curvature coefficient μ 3
Flexible tubing; non-galvanized	0.0005-0.0010	0.18-0.26
galvanized	0.0003-0.0007	0.14-0.22
Rigid thin wall tubing; non-galvanized	0.0001-0.0005	0.20-0.30
galvanized	0.0000-0.0004	0.16-0.24
Greased and wrapped	0.0005-0.0015	0.05-0.15
b - RECOMMENDED VALUES		
Type of Tendon 1	Wobble coefficient K (per ft) 2	Curvature coefficient μ 3
Flexible tubing; non-galvanized	0.0075	0.22
galvanized	0.0005	0.18
Rigid thin wall tubing; non-galvanized	0.0003	0.25
galvanized	0.0002	0.20
Greased and wrapped	0.0010	0.07

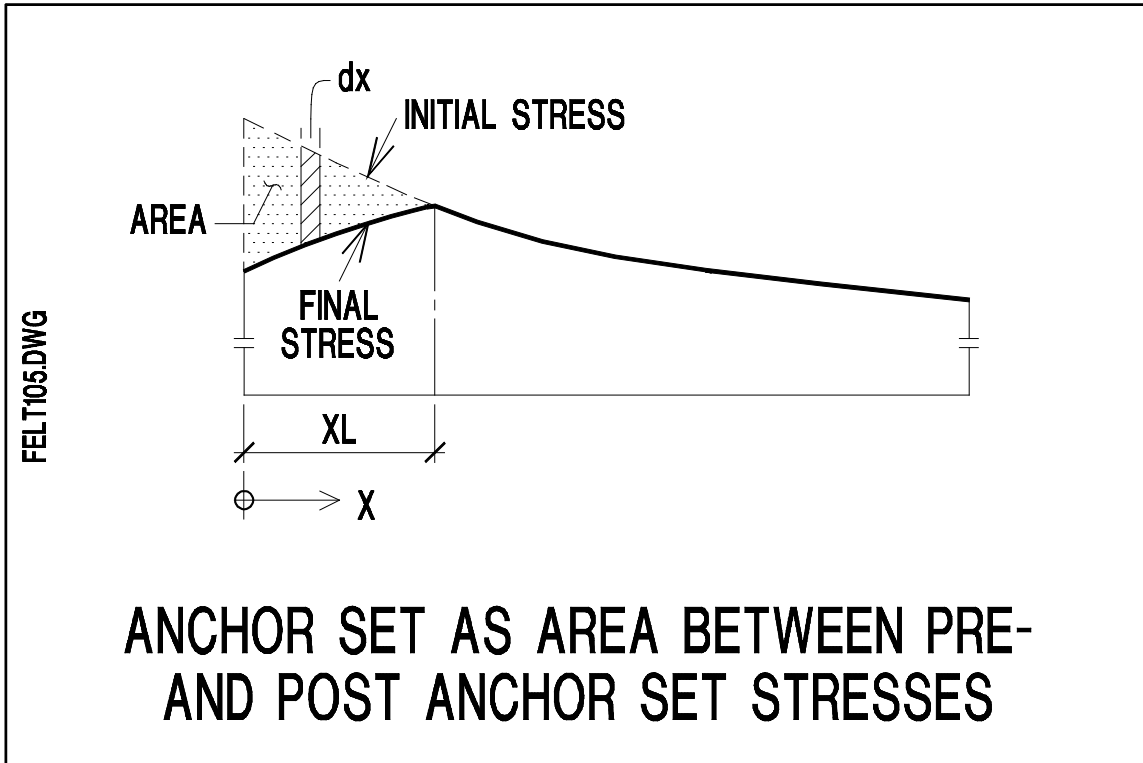

FIGURE 4.2-1

The average stress and elongations are based on the resulting area under the stress diagram. This area is calculated using numerical integration.

4.3 LONG-TERM STRESS LOSSES

The following describes the relationships used for long-term stress losses (Zia et al., 1979).

4.3.1 Elastic Shortening of Concrete (ES)

A. For members with unbonded tendons

$$ES = K_{es} * (E_s / E_{ci}) * f_{cpa}$$

where,

$$K_{es} = 0.5 \text{ for post-tensioned members when tendons are tensioned sequentially to the same tension;}$$

$$E_s = \text{strand's modulus of elasticity;}$$

E_{ci} = concrete's modulus of elasticity at stressing age;
 f_{cpa} = average compressive stress in the concrete at the time immediately after stressing, and a hypothetical location defined by the center of gravity of tendons. Note that the stress referred to at the centroid of tendon is larger than the average compression in a member.

B. For members with bonded tendons

$$ES = K_{es} * (E_s / E_{ci}) * f_{cir}$$

where,

K_{es} = 0.5 for post-tensioned members as described in the preceding equation, 1.0 for pretensioned members, and 0.0 for post-tensioned members if all tendons are stressed and anchored simultaneously;

$$f_{cir} = K_{cir} * f_{cpi} - f_g$$

where,

f_{cir} = net stress in concrete at center of gravity of tendons immediately after prestress has been applied to concrete;

K_{cir} = 1.0 for post-tensioned members, and 0.9 for pretensioned members;

f_{cpi} = Stress in concrete at center of gravity of tendons due to prestressing forces immediately after prestress has been applied;

f_g = stress in concrete at center of gravity of tendons due to weight of structure at time prestress is applied (positive if tension).

4.3.2 Creep of Concrete (CR)

A. For members with unbonded tendons

$$CR = K_{cr} * (E_s / E_c) * f_{cpa}$$

where,

$$K_{cr} = 1.60$$

E_c = concrete's modulus of elasticity at 28 days.

B. For members with bonded tendons

$$CR = K_{cr} * (E_s/E_c) * (f_{cir} - f_{cds})$$

where,

K_{cr} = 2.0 for pretensioned members, and 1.6 for post-tensioned members;

f_{cds} = stress in concrete at center of gravity of tendons due to all superimposed permanent dead loads that are applied to the member after it has been prestressed.

However, for bonded systems and pretensioned members made of sand lightweight concrete, the foregoing values of K_{cr} should be reduced by 20 percent.

4.3.3 Shrinkage of Concrete (SH)

$$SH = 8.2 * 10^{-6} * K_{sh} * E_s * [1 - 0.06 * (V/S)] * (100 - RH)$$

where,

K_{sh} = is a constant defined in **Table 4.3-1**;

V/S = volume to surface ratio;

RH = relative humidity (percent). For the annual average ambient relative humidity see **Figure 4.3-1**.

TABLE 4.3-1 SHRINKAGE CONSTANT K_{sh}

DAYS*	1	3	5	7	10	20	30	60
K_{sh}	0.92	0.85	0.80	0.77	0.73	0.64	0.58	0.45

* DAYS refers to time after end of moist curing to application of prestressing.

For stressing past 60 days after curing a constant value of 0.45 is assumed.

4.3.4 Relaxation of Tendon (RE)

$$RE = [K_{re} - J * (SH + CR + ES)] * C$$

where the values of the constants K_{re} , J and C are to be taken from the following two tables:

TABLE 4.3-2 STRESS RELAXATION CONSTANTS K_{re} AND J

	Grade and type*	K_{re}	J
STRESS RELIEVED	270 strand or wire	20000	0.15
	250 strand or wire	18500	0.14
	240 wire	17600	0.13
	235 wire	17600	0.13
	160 bar	6000	0.05
	145 bar	6000	0.05
LOW RELAXATION	270 strand	5000	0.040
	250 wire	4630	0.037
	240 wire	4400	0.035
	235 wire	4400	0.035

* In accordance with ASTM A416-74, ASTM A421-76, ASTM A722-75.

For strands having specified ultimate strengths with values between the limits given in the table linear interpolation is used.

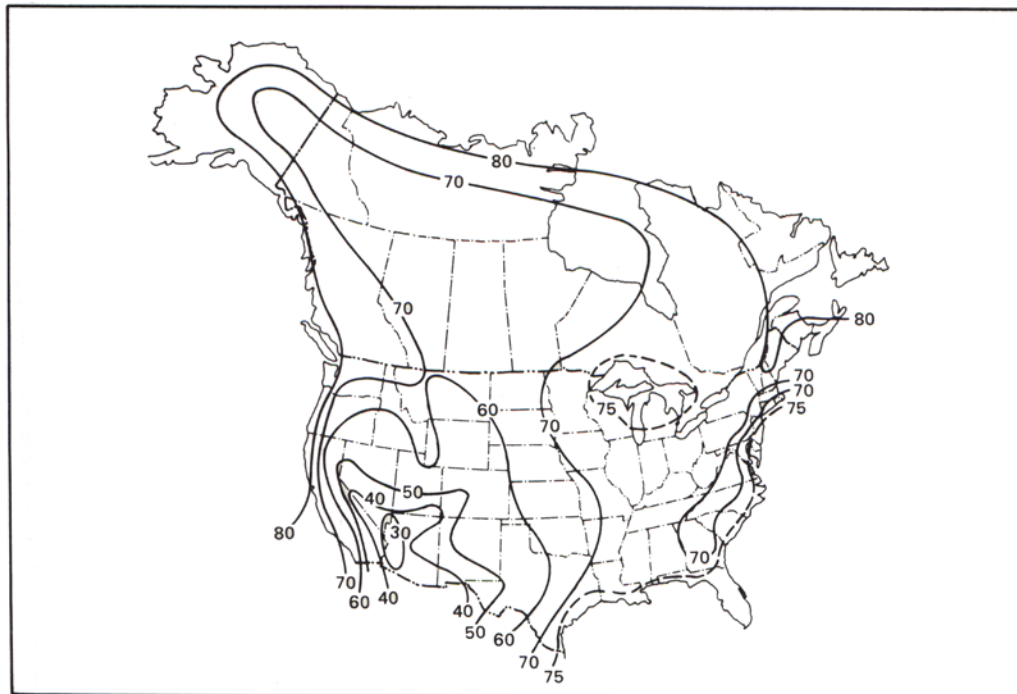

FIGURE 4.3-1 ANNUAL AVERAGE AMBIENT RELATIVE HUMIDITY, PERCENT

For conditions which fall outside the range of data provided in the preceding table (Zia et al. 1979), ADAPT-FELT assumes the following values for the purpose of providing an initial estimate for long-term stress losses:

For stress relieved case:

For $0.75 < (f_{pi}/f_{pu}) < 0.95$, $C = 1.75$

For $0.00 < (f_{pi}/f_{pu}) < 0.60$, $C =$ linear between 0.49 and 0

For low relaxation strands:

For $0.80 < (f_{pi}/f_{pu}) < 0.95$, $C = 1.36$

For $0.00 < (f_{pi}/f_{pu}) < 0.60$, $C =$ linear between 0.33 and 0

Outside these ranges and the range of the table an error message is flagged during the execution of ADAPT-FELT. It is emphasized that the assumed values are extrapolations to provide a rough approximate first estimate.

TABLE 4.3-3 STRESS RELAXATION CONSTANT C

f_{pi}/f_{pu}	Stress Relieved Strand or Wire	Stress Relieved Bar or Low Relaxation Strand or Wire
0.80		1.28
0.79		1.22
0.78		1.16
0.77		1.11
0.76		1.05
0.75	1.45	1.00
0.74	1.36	0.95
0.73	1.27	0.90
0.72	1.18	0.85
0.71	1.09	0.80
0.70	1.00	0.75
0.69	0.94	0.70
0.68	0.89	0.66
0.67	0.83	0.61
0.66	0.78	0.57
0.65	0.73	0.53
0.64	0.68	0.49
0.63	0.63	0.45
0.62	0.58	0.41
0.61	0.53	0.37
0.60	0.49	0.33

Chapter 5

EXAMPLES

5.1	EXAMPLES IN AMERICAN STANDARD UNITS	59
5.1.1	Box Girder Bridge Example - Grouted Tendon	59
5.1.2	Beam Example from ADAPT Post-tensioning Software	64
5.1.3	Circular Water Tank Example - General Profile	69
5.2	EXAMPLES IN SI UNITS	75
5.2.1	Box Girder Bridge Example - Grouted Tendon	75
5.2.2	Beam Example From Adapt Post-Tensioning Software	79
5.2.3	Circular Water Tank Example - General Profile	83

This Page Left Intentionally

BLANK

5.1 EXAMPLES IN AMERICAN STANDARD UNITS

5.1.1 Box Girder Bridge Example - Grouted Tendon

The following is a calculation for the box girder bridge example given on page 23 of PTI's *Post-Tensioned Box Girder Bridge Manual*. Note that the distribution of stress obtained from ADAPT-FELT is slightly different from the PTI example due to the fact that the PTI distribution is based on a lesser number of ordinates (refer to the diagram of stress distribution at the end of the computer printout). The diagram shown below is reproduced from the PTI manual:

FELT106.DWG

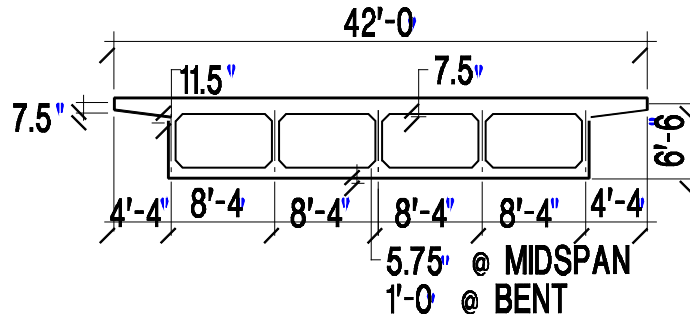

TYPICAL SECTION

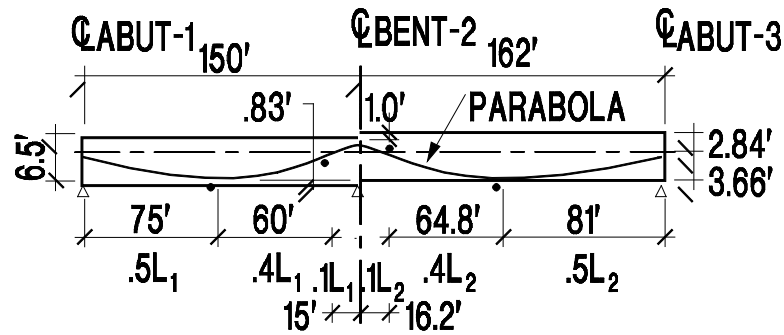

TENDON (C.G.S.) PROFILE

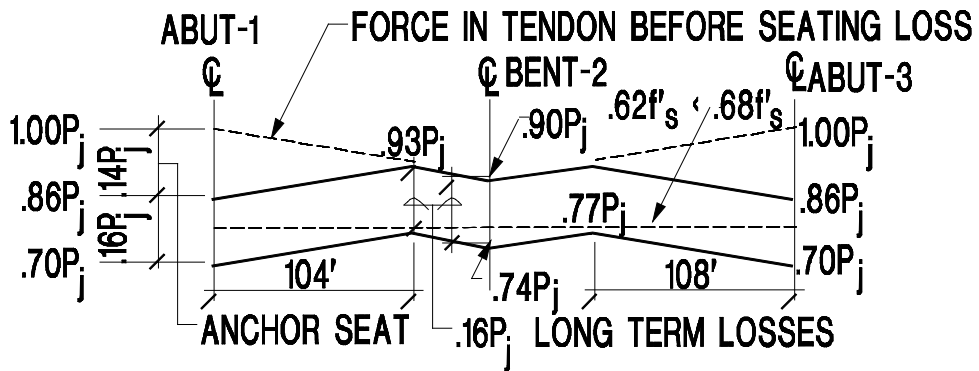

FORCE IN TENDON

BOX BRIDGE EXAMPLE

FIGURE 5.1-1

```

-----
                ADAPT Corporation, Redwood City, CA, USA
                ADAPT International Pvt. Ltd., Kolkata, India
                ADAPT Latin America, Miami, FL, USA
                support@adaptsoft.com, www.adaptsoft.com
-----

                ADAPT-FELT Standard 2011
                ADAPT POST-TENSIONING STRESS LOSS & ELONGATION PROGRAM
                This program calculates the long-term and immediate stress losses in a post-
                tensioned tendon. It outputs the elongations at the stressing ends and the
                final stress profile along the tendon.
-----

DATE: Jan  5, 2011                                     TIME: 18:52:53

PROJECT TITLE :
POST-TENSIONING BOX GIRDER BRIDGE MANUAL EXAMPLE

SPECIFIC TITLE :
TWO-SPAN BOX GIRDER

LONG - TERM LOSS CALCULATIONS :

INPUT PARAMETERS :

Long-term stress losses due to shrinkage, creep, elastic
shortening and stress-relaxation are estimated to a
total lump sum of ..... 33.00 ksi
    
```

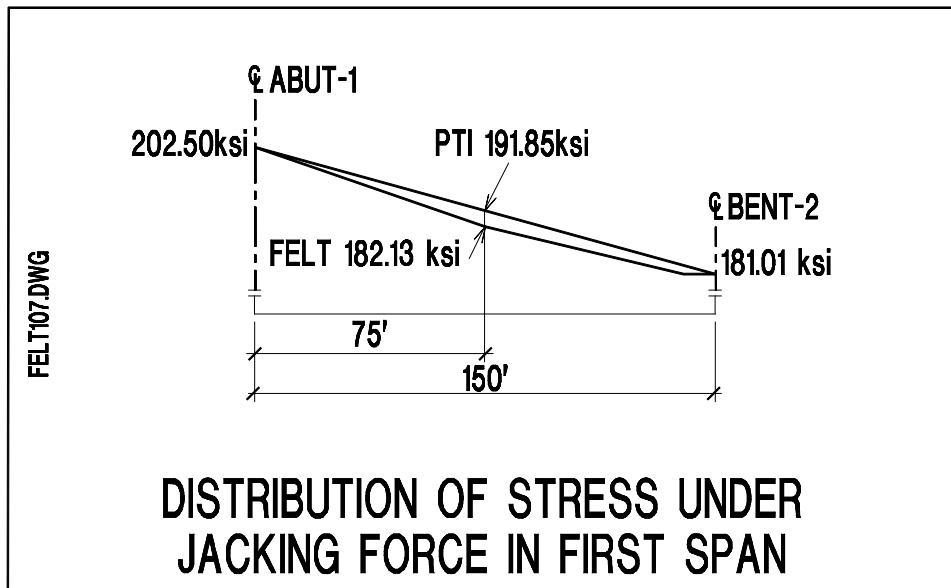

FIGURE 5.1-2

F R I C T I O N & E L O N G A T I O N C A L C U L A T I O N S :

INPUT PARAMETERS :

Coefficient of angular friction (meu).....	.25000	/radian
Coefficient of wobble friction (K).....	.00020	rad/ft
Ultimate strength of strand	270.00	ksi
Ratio of jacking stress to strand's ultimate strength	.75	
Anchor set63	inch
Cross-sectional area of strand153	inch ²
Total Number of Strands per Tendon.....	1	
Modulus of elasticity of strand	29000.00	ksi
STRESSING	AT BOTH ENDS	

LEGEND :

P = Tendon profile type defined as: 1=reversed parabola;
 2=partial/regular parabola; 3=harped; 4=general
 X1/L etc = horizontal distances to control points in geometry of the
 tendon divided by span length
 Stresses tabulated are after anchor set but before long-term losses.

TENDON ID, GEOMETRY AND STRESS PROFILE (Los-ex2)

SPAN	ft	P	LENGTH < TENDON HEIGHT in.>			Horizontal ratios			<- STRESS (ksi) -->		
			start	center	right	X1/L	X2/L	X3/L	start	center	right
-1----	2-----	3-----	4-----	5-----	6-----	7-----	8-----	9-----	10-----	11-----	12-
1	150.00	1	44.00	10.00	66.00	.00	.50	.10	172.28	182.13	181.01
2	162.00	1	66.00	10.00	44.00	.10	.50	.00	181.01	183.40	173.81

 312.00 ft (total length of tendon)

SUMMARY :

Average initial stress (after release).....	182.25	ksi
Long term stress losses	33.00	ksi
Final average stress	149.25	ksi
Final average force in tendon	22.83	k
Anchor set influence from left pull (187.39ksi; .694) ..	114.94	ft
Anchor set influence from right pull (188.16ksi; .697) ..	121.19	ft
Elongation at left pull before anchor set	23.17	inch
Elongation at right pull before anchor set	1.61	inch
Elongation at left pull after anchor set	22.54	inch
Elongation at right pull after anchor set98	inch
Total elongation after anchor set	23.53	inch
Ratio of total elongation to tendon length after anchor set08	inch/ft
Jacking force	30.98	k

CRITICAL STRESS RATIOS :

At stressing .75; At anchorage .64; Max along tendon .70

DETAIL OF STRESSES AT 1/20TH POINTS ALONG EACH SPAN

Units are in ksi

X/L	Span 1	Span 2
.00	172.28	181.01
.05	176.17	183.92
.10	176.84	185.21
.15	177.51	186.17
.20	178.18	187.14
.25	178.84	188.12
.30	179.51	187.21
.35	180.17	186.22
.40	180.82	185.23
.45	181.48	184.23
.50	182.13	183.40
.55	182.98	182.75
.60	184.01	182.10
.65	185.03	181.44
.70	186.05	180.79
.75	187.06	180.13
.80	186.71	179.46
.85	185.72	178.80
.90	184.73	178.14
.95	183.39	177.47
1.00	181.01	173.81

TENDON HEIGHT AT 1/20TH POINTS ALONG EACH SPAN

Units are in inch

X/L	Span 1	Span 2
.00	44.00	66.00
.05	37.54	63.20
.10	31.76	54.80
.15	26.66	44.30
.20	22.24	35.20
.25	18.50	27.50
.30	15.44	21.20
.35	13.06	16.30
.40	11.36	12.80
.45	10.34	10.70
.50	10.00	10.00
.55	10.70	10.34
.60	12.80	11.36
.65	16.30	13.06
.70	21.20	15.44
.75	27.50	18.50
.80	35.20	22.24
.85	44.30	26.66
.90	54.80	31.76
.95	63.20	37.54
1.00	66.00	44.00

5.1.2 Beam Example from ADAPT Post-tensioning Software

The following is a friction and long-term stress loss calculation for the beam example given in Chapter 5 of ADAPT post-tensioning software manual. The tendon profile is a combination of simple parabola with straight lengths over the supports and an inverted parabola in the third span. The overall dimensions of the beam are shown on the following page. Tables of the horizontal and vertical distances to the critical points of the tendons are reproduced below from the ADAPT output.

Note that in the preparation of data the modulus of elasticity of concrete at stressing is entered as 3122 ksi. This is obtained by using the ACI relationship of $E_{ci} = 57 \cdot (3000)^{1/2}$, for f'_{ci} equal to 3000 psi at stressing.

```

===== EXCERPT FROM ADAPT OUTPUT =====

9.1 PROFILE TYPES AND PARAMETERS
LEGEND:
1 = reversed parabola
2 = simple parabola with straight portion over support
3 = harped tendon

9.2 T E N D O N   P A R A M E T E R S
      TYPE  X1/L  X2/L  X3/L  A/L
-----1-----2-----3-----4-----5-----
1      2      .031  .500  .031  .000
2      2      .036  .500  .000  .000
3      2      .000  .500  .059  .000

      <---- 9.3 SELECTED VALUES ---->   <-- 9.4 CALCULATED VALUES -->
      FORCE * <--DISTANCE OF CGS in.-->   P/A      Wbal      TOTAL FORCE
SPAN  (k /-)  Left  Center  Right  (psi)   (k /-)   (k )
-----1-----2-----3-----4-----5-----6-----7-----8-----
1      347.00  22.73  3.25  31.75  342.89  1.444   347.00
2      203.00  31.75  10.00  31.75  200.59  1.011   203.00
3      203.00  31.75  28.00  22.73  200.59  -.521   203.00

* ALL distances are heights from soffit of respective member at mid-span
Approximate weight of strand ..... 780.3 LB

=====

```

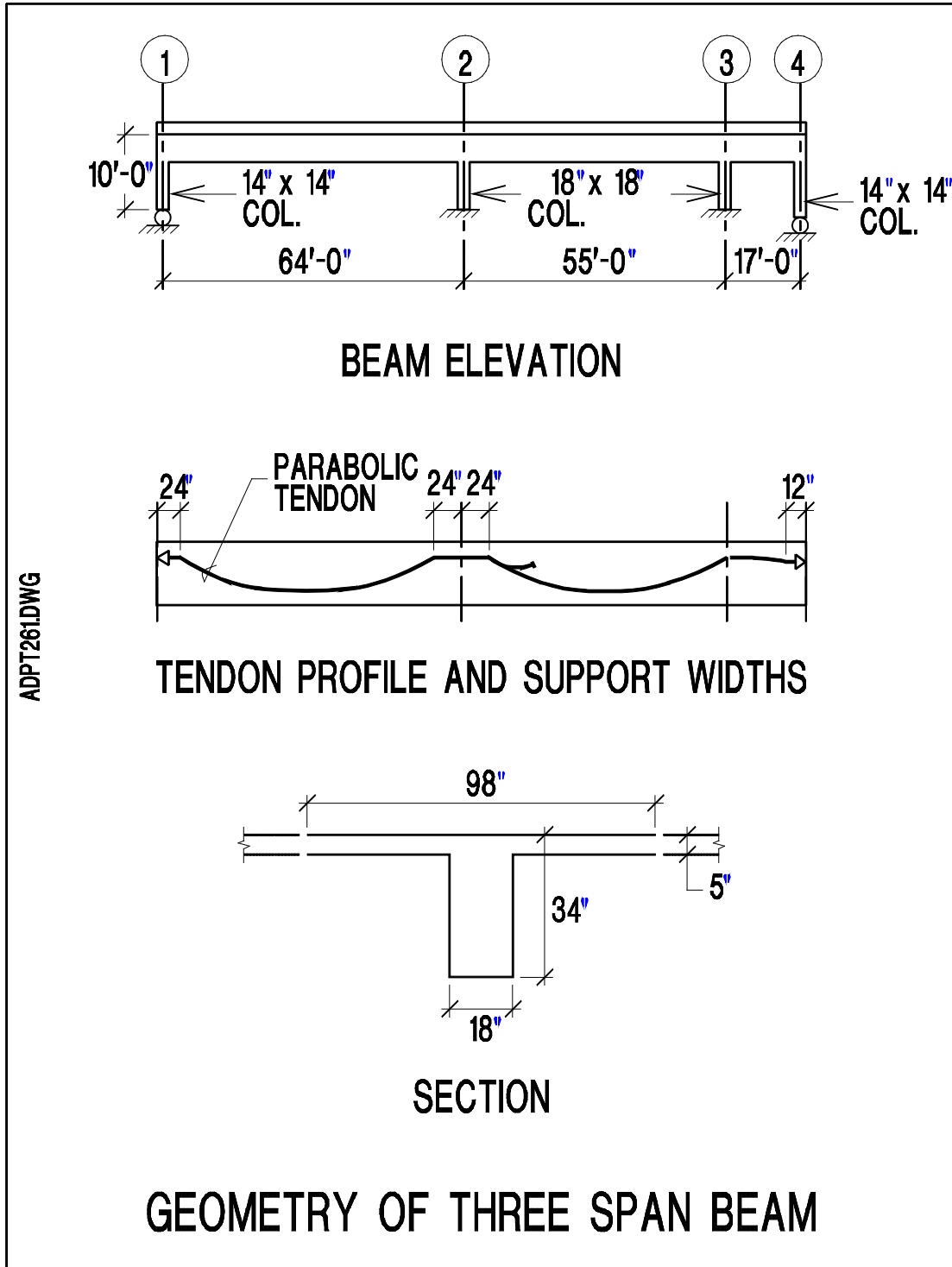

FIGURE 5.1-3

```

-----
ADAPT Corporation, Redwood City, CA, USA
ADAPT International Pvt. Ltd., Kolkata, India
ADAPT Latin America, Miami, FL, USA
support@adaptsoft.com, www.adaptsoft.com
-----

```

```

-----
ADAPT-FELT Standard 2011
ADAPT POST-TENSIONING STRESS LOSS & ELONGATION PROGRAM
This program calculates the long-term and immediate stress losses in a post-
tensioned tendon. It outputs the elongations at the stressing ends and the
final stress profile along the tendon.
-----

```

DATE: Jan 5, 2011

TIME: 19:02:47

PROJECT TITLE :
FELT LONG-TERM LOSS AND FRICTION CALCULATIONS

SPECIFIC TITLE :
ADAPT BEAM EXAMPLE

LONG - TERM LOSS CALCULATIONS :

INPUT PARAMETERS :

Post-tensioning system	UNBONDED	
Type of strand	LOW LAX	
Ultimate strength of strand	270.00	ksi
Modulus of elasticity of strand	28000.00	ksi
Estimate of initial average compression	203.00	psi
Concrete strength at 28 days	4000.00	psi
Average weight of concrete	NORMAL	
Estimated age of concrete at stressing	4	days
Modulus of elasticity of concrete at stressing	3122.00	ksi
Modulus of elasticity of concrete at 28 days	3604.00	ksi
Estimate of average relative humidity	70.	%
Volume to surface ratio of member	3.98	in

CALCULATED VALUES :

Elastic shortening910	ksi
Shrinkage	4.326	ksi
Creep	2.523	ksi
Relaxation	3.752	ksi

Total long-term stress losses	11.511	ksi

```

FR I C T I O N   &   E L O N G A T I O N   C A L C U L A T I O N S   :

INPUT PARAMETERS :
Coefficient of angular friction (meu).....          .08000 /radian
Coefficient of wobble friction (K).....            .00180 rad/ft
Ultimate strength of strand .....                270.00   ksi
Ratio of jacking stress to strand's ultimate strength .80
Anchor set .....                                .25   inch
Cross-sectional area of strand .....              .153   inch^2
Total Number of Strands per Tendon.....           1
STRESSING .....                                  AT BOTH ENDS

LEGEND :
P ..... = Tendon profile type defined as: 1=reversed parabola;
          2=partial/regular parabola; 3=harped; 4=general
X1/L etc = horizontal distances to control points in geometry of the
          tendon divided by span length
Stresses tabulated are after anchor set but before long-term losses.

TENDON ID,  GEOMETRY AND STRESS PROFILE  (Los-ex3)

      LENGTH  < TENDON HEIGHT in.>  Horizontal ratios  <- STRESS (ksi) -->
SPAN  ft     P  start center right  X1/L X2/L X3/L  start center right
-1----2-----3----4-----5-----6-----7----8----9-----10-----11-----12-
-----
  1   64.00  2   22.73  3.25 31.75   .03 .50 .03   183.72 196.90 188.47
  2   55.00  2   31.75 10.00 31.75   .04 .50 .00   183.94 190.43 186.34
  3   17.00  2   31.75 28.00 22.73   .00 .50 .06   186.34 182.03 175.83
-----
      136.00 ft (total length of tendon)

SUMMARY :
Average initial stress (after release).....        189.37  ksi
Long term stress losses .....                     11.51  ksi
Final average stress .....                        177.86  ksi
Final average force in tendon .....                27.21  k

Anchor set influence from left pull (198.88ksi; .737) .. 36.56  ft
Anchor set influence from right pull (195.75ksi; .725) .. 31.88  ft
Elongation at left pull before anchor set .....    10.73  inch
Elongation at right pull before anchor set .....   .81  inch
Elongation at left pull after anchor set .....     10.48  inch
Elongation at right pull after anchor set .....    .56  inch
Total elongation after anchor set .....            11.04  inch
Ratio of total elongation to
      tendon length after anchor set .....          .08  inch/ft
Jacking force .....                               33.05  k

CRITICAL STRESS RATIOS :
At stressing .80; At anchorage .67; Max along tendon .74
    
```

DETAIL OF STRESSES AT 1/20TH POINTS ALONG EACH SPAN

Units are in ksi

X/L	Span 1	Span 2	Span 3
.00	181.75	186.19	186.34
.05	183.72	183.94	185.91
.10	185.88	181.52	185.47
.15	187.29	182.37	185.04
.20	188.69	183.50	184.60
.25	190.08	184.64	184.16
.30	191.46	185.78	183.72
.35	192.83	186.94	183.28
.40	194.20	188.10	182.84
.45	195.55	189.27	182.40
.50	196.90	190.43	182.03
.55	198.28	191.57	181.48
.60	198.06	192.73	180.94
.65	196.66	193.89	180.39
.70	195.27	195.06	179.84
.75	193.89	195.27	179.29
.80	192.52	194.09	178.74
.85	191.16	192.90	178.19
.90	189.81	191.70	177.69
.95	188.47	190.50	175.83
1.00	186.19	186.34	175.50

TENDON HEIGHT AT 1/20TH POINTS ALONG EACH SPAN

Units are in inch

X/L	Span 1	Span 2	Span 3
.00	22.73	31.75	31.75
.05	21.11	30.82	31.04
.10	17.36	26.45	30.40
.15	14.05	22.59	29.84
.20	11.19	19.25	29.35
.25	8.76	16.42	28.94
.30	6.78	14.11	28.60
.35	5.23	12.31	28.34
.40	4.13	11.03	28.15
.45	3.47	10.26	28.04
.50	3.25	10.00	28.00
.55	3.57	10.22	27.93
.60	4.54	10.87	27.73
.65	6.15	11.96	27.39
.70	8.41	13.48	26.91
.75	11.31	15.44	26.30
.80	14.86	17.83	25.55
.85	19.06	20.66	24.66
.90	23.89	23.92	23.65
.95	29.38	27.62	22.73
1.00	31.75	31.75	22.73

5.1.3 Circular Water Tank Example - General Profile

This example demonstrates the use of the general tendon profile. Consider a circular cylindrical tank prestressed with horizontal grouted tendons.

Figure 5.1-4 shows the arrangement of tendons. Each tendon covers one-half of the perimeter. It is straight at the ends with stressing details as shown in **Figure 5.1-4(b)**. Coefficients of the angular and wobble friction are 0.3/radian and 0.0002/ft respectively. A lump sum stress loss of 25 ksi is specified. It is required to determine the stress distribution and the effective final stress in tendon.

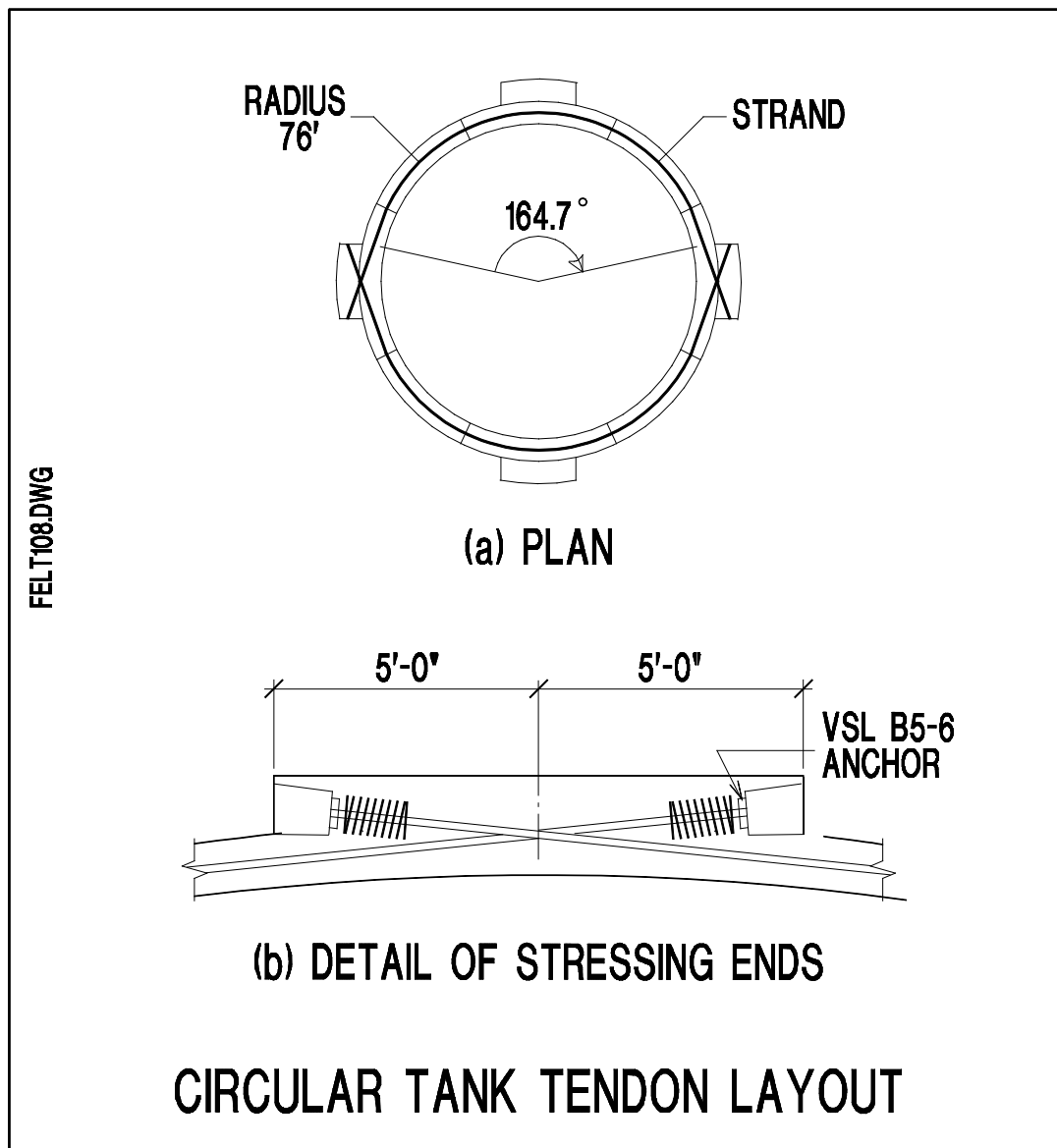

FIGURE 5.1-4

To approximate the curved portion, the tendon of span 2 is broken into nine segments using tendon Type 4 in the input. This tendon type allows the user to specify the endpoint coordinates of each segment and the angle change at the right end of each segment. Note that the last segment in span 2 is assigned a zero angle change. This is done to get a symmetrical answer since the angle change is always on the right end of each segment. Spans 1 and 3 represent the straight segments at each anchorage. Keep in mind, the more segments and angle changes that are specified, the closer will be the results to the actual condition.

```

-----
                ADAPT Corporation, Redwood City, CA, USA
                ADAPT International Pvt. Ltd., Kolkata, India
                ADAPT Latin America, Miami, FL, USA
                support@adaptsoft.com, www.adaptsoft.com
-----

                ADAPT-FELT Standard 2011
                ADAPT POST-TENSIONING STRESS LOSS & ELONGATION PROGRAM
This program calculates the long-term and immediate stress losses in a post-
tensioned tendon. It outputs the elongations at the stressing ends and the
final stress profile along the tendon.
-----
DATE: Jan 5, 2011                                TIME: 17:14:43

P R O J E C T   T I T L E :
WATER TANK FRICTION AND ELONGATION CALCULATION

S P E C I F I C   T I T L E :
CRESTVIEW WATER TANK

L O N G - T E R M   L O S S   C A L C U L A T I O N S :

INPUT PARAMETERS :

Long-term stress losses due to shrinkage, creep, elastic
shortening and stress-relaxation are estimated to a
total lump sum of .....                25.00    ksi

```



```

FR I C T I O N   &   E L O N G A T I O N   C A L C U L A T I O N S   :

INPUT PARAMETERS :
Coefficient of angular friction (meu)..... .30000 /radian
Coefficient of wobble friction (K)..... .00020 rad/ft
Ultimate strength of strand ..... 270.00 ksi
Ratio of jacking stress to strand's ultimate strength
Anchor set ..... .80
Cross-sectional area of strand ..... .153 inch^2
Total Number of Strands per Tendon..... 1
Modulus of elasticity of strand ..... 29000.00 ksi
STRESSING ..... AT BOTH ENDS

LEGEND :
P ..... = Tendon profile type defined as: 1=reversed parabola;
          2=partial/regular parabola; 3=harped; 4=general
X1/L etc = horizontal distances to control points in geometry of the
          tendon divided by span length
Stresses tabulated are after anchor set but before long-term losses.

TENDON ID, GEOMETRY AND STRESS PROFILE (Los-ex8)

      LENGTH < TENDON HEIGHT in.> Horizontal ratios <- STRESS (ksi) -->
SPAN ft   P start center right X1/L X2/L X3/L start center right
-1-----2-----3-----4-----5-----6-----7-----8-----9-----10-----11-----12-
1  10.00  4 (angle changes = .0) 216.00 215.78 215.57
2  217.16 4 (angle changes = 164.7) 215.57 137.08 215.57
3  10.00  4 (angle changes = .0) 215.57 215.78 216.00
-----
      237.16 ft (total length of tendon)

SUMMARY :
Average initial stress (after release)..... 176.98 ksi
Long term stress losses ..... 25.00 ksi
Final average stress ..... 151.98 ksi
Final average force in tendon ..... 23.25 k

Anchor set influence from left pull (216.00ksi; .800) .. .00 ft
Anchor set influence from right pull (216.00ksi; .800) .. .00 ft
Elongation at left pull before anchor set ..... 14.00 inch
Elongation at right pull before anchor set ..... 3.37 inch
Elongation at left pull after anchor set ..... 14.00 inch
Elongation at right pull after anchor set ..... 3.37 inch
Total elongation after anchor set ..... 17.37 inch
Ratio of total elongation to
tendon length after anchor set ..... .07 inch/ft
Jacking force ..... 33.05 k

CRITICAL STRESS RATIOS :
At stressing .80; At anchorage .80; Max along tendon .80
    
```

DETAIL OF STRESSES AT 1/20TH POINTS ALONG EACH SPAN

Units are in ksi

X/L	Span 1	Span 2	Span 3
.00	216.00	215.57	215.57
.05	215.98	206.03	215.59
.10	215.96	196.91	215.61
.15	215.94	188.19	215.63
.20	215.91	179.86	215.65
.25	215.89	171.90	215.68
.30	215.87	164.29	215.70
.35	215.85	157.02	215.72
.40	215.83	150.07	215.74
.45	215.81	143.43	215.76
.50	215.78	137.08	215.78
.55	215.76	143.43	215.81
.60	215.74	150.07	215.83
.65	215.72	157.02	215.85
.70	215.70	164.29	215.87
.75	215.68	171.90	215.89
.80	215.65	179.86	215.91
.85	215.63	188.19	215.94
.90	215.61	196.91	215.96
.95	215.59	206.03	215.98
1.00	215.57	215.57	216.00

TENDON HEIGHT AT 1/20TH POINTS ALONG EACH SPAN

Units are in inch

X/L	Span 1	Span 2	Span 3
.00	.00	.00	.00
.05	.00	.00	.00
.10	.00	.00	.00
.15	.00	.00	.00
.20	.00	.00	.00
.25	.00	.00	.00
.30	.00	.00	.00
.35	.00	.00	.00
.40	.00	.00	.00
.45	.00	.00	.00
.50	.00	.00	.00
.55	.00	.00	.00
.60	.00	.00	.00
.65	.00	.00	.00
.70	.00	.00	.00
.75	.00	.00	.00
.80	.00	.00	.00
.85	.00	.00	.00
.90	.00	.00	.00
.95	.00	.00	.00
1.00	.00	.00	.00

DETAILED POLYLINE INFORMATION					
SPAN	LENGTH (ft)	TYPE	X (ft)	Y (in.)	BETA degree
1	10.00	4	.00 10.00	.00 .00	.00 .00
2	217.16	4	.00 24.13 48.26 72.39 96.52 120.65 144.78 168.91 193.04 217.16	.00 .00 .00 .00 .00 .00 .00 .00 .00 .00	.00 20.59 20.59 20.59 20.59 20.59 20.59 20.59 20.59 20.59 .00
3	10.00	4	.00 10.00	.00 .00	.00 .00

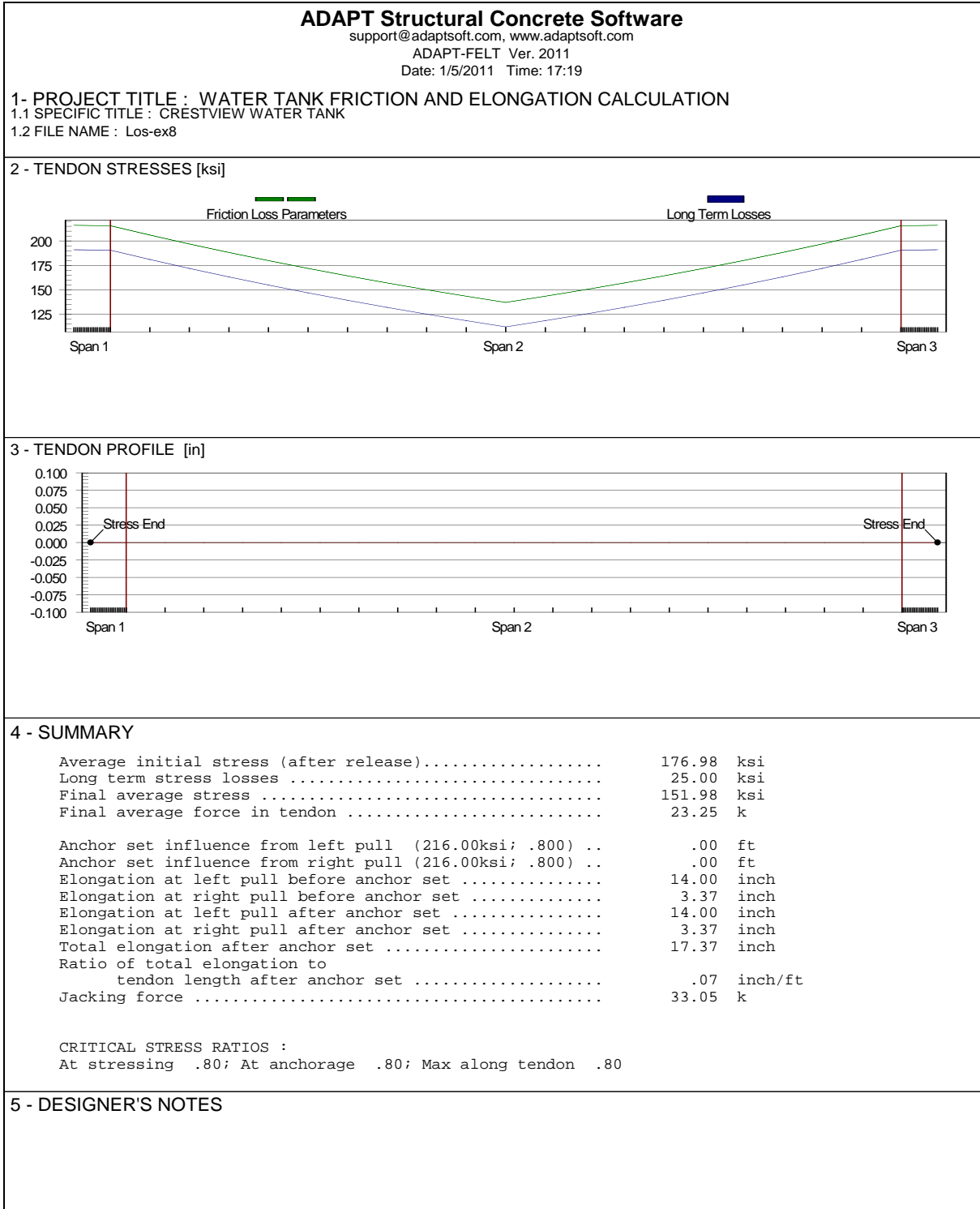

FIGURE 5.1-5

5.2 EXAMPLES IN SI UNITS

5.2.1 Box Girder Bridge Example - Grouted Tendon

The following is a calculation for the box girder bridge example given on page 23 of PTI's *Post-Tensioned Box Girder Bridge Manual*. Note that the distribution of stress obtained from ADAPT-FELT is slightly different from the PTI example due to the fact that the PTI distribution is based on a lesser number of ordinates (refer to the diagram of stress distribution at the end of the computer printout). The diagram shown below is reproduced from the PTI manual:

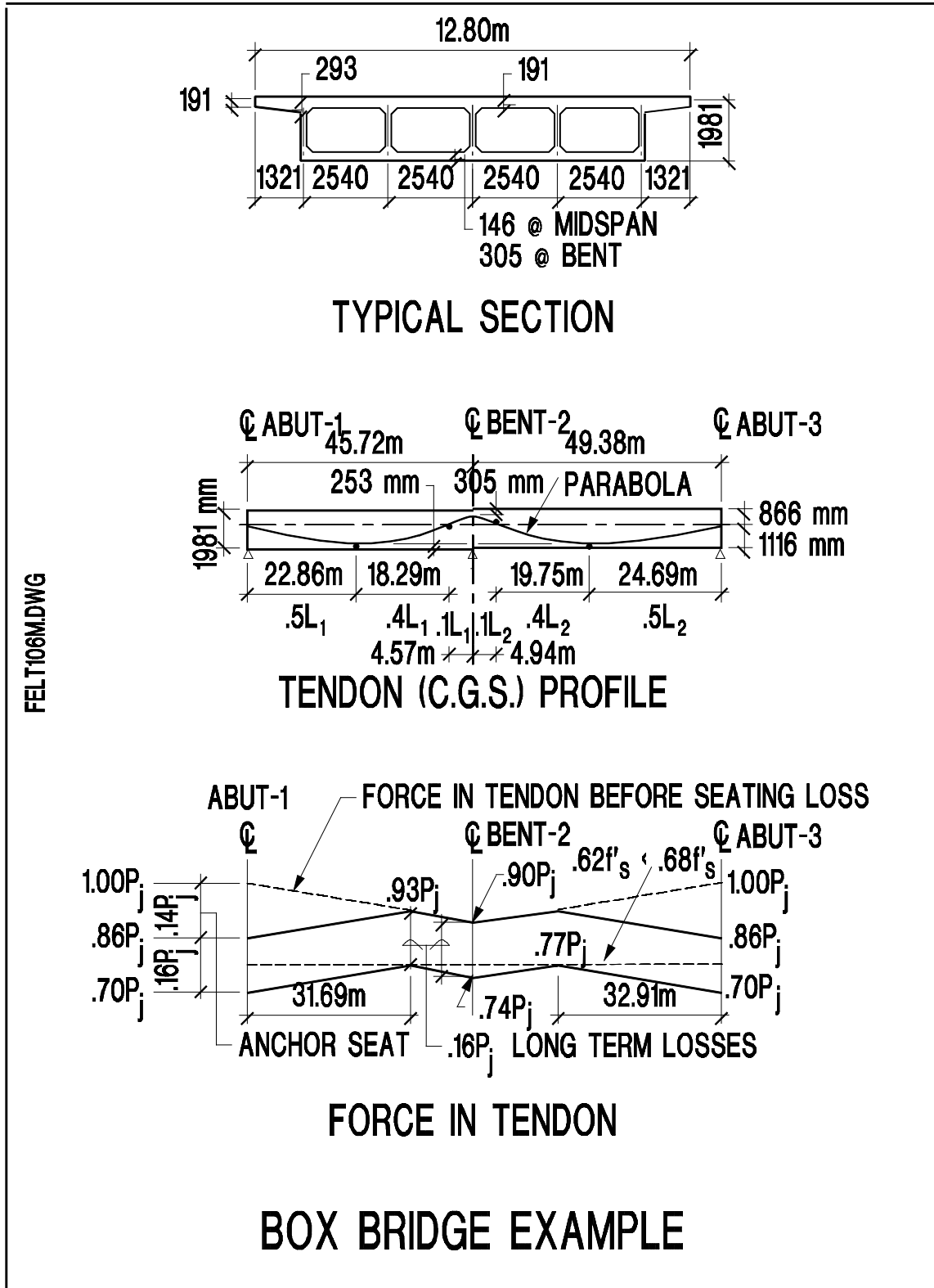

FIGURE 5.2-1

```

-----
                ADAPT Corporation, Redwood City, CA, USA
                ADAPT International Pvt. Ltd., Kolkata, India
                ADAPT Latin America, Miami, FL, USA
                support@adaptsoft.com, www.adaptsoft.com
-----

                ADAPT-FELT Standard 2011
                ADAPT POST-TENSIONING STRESS LOSS & ELONGATION PROGRAM
This program calculates the long-term and immediate stress losses in a post-
tensioned tendon. It outputs the elongations at the stressing ends and the
final stress profile along the tendon.
-----

DATE: Jan  5, 2011                                TIME: 17:25:32

PROJECT TITLE :
TWO-SPAN POST-TENSIONED BOX GIRDER

SPECIFIC TITLE :
(LOSM-EX2)

LONG-TERM LOSS CALCULATIONS :

INPUT PARAMETERS :

Long-term stress losses due to shrinkage, creep, elastic
shortening and stress-relaxation are estimated to a
total lump sum of .....                227.00    N/mm^2
    
```

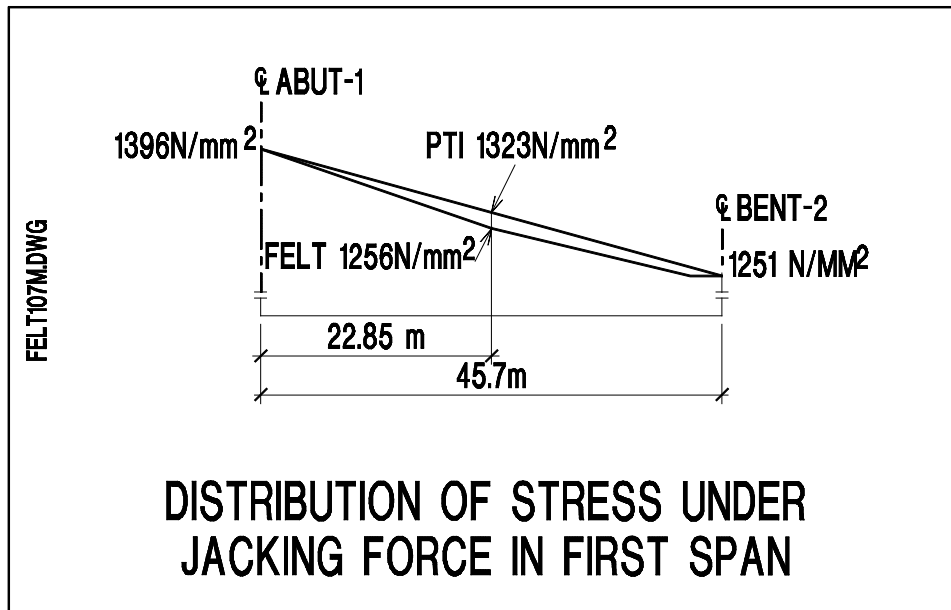

FIGURE 5.2-2

F R I C T I O N & E L O N G A T I O N C A L C U L A T I O N S :

INPUT PARAMETERS :

Coefficient of angular friction (meu).....	.25000	/radian
Coefficient of wobble friction (K).....	.00060	rad/m
Ultimate strength of strand	1861.00	N/mm ²
Ratio of jacking stress to strand's ultimate strength	.75	
Anchor set	16.00	mm
Cross-sectional area of strand	95.630	mm ²
Total Number of Strands per Tendon.....	1	
Modulus of elasticity of strand	199900.00	N/mm ²
STRESSING		AT BOTH ENDS

LEGEND :

P = Tendon profile type defined as: 1=reversed parabola;
 2=partial/regular parabola; 3=harped; 4=general
 X1/L etc = horizontal distances to control points in geometry of the
 tendon divided by span length
 Stresses tabulated are after anchor set but before long-term losses.

TENDON ID, GEOMETRY AND STRESS PROFILE (LOSM-EX2)

SPAN	m	P	< TENDON HEIGHT mm.>			Horizontal ratios			<- STRESS (N/mm ²)->		
			start	center	right	X1/L	X2/L	X3/L	start	center	right
-1---	2----	3----	4-----	5-----	6-----	7-----	8-----	9-----	10-----	11-----	12-
1	45.72	1	1118.0	254.0	1676.0	.00	.50	.10	1190.06	1256.29	1251.10
2	49.38	1	1676.0	254.0	1118.0	.10	.50	.00	1251.10	1265.04	1200.78

			95.10 m (total length of tendon)								

SUMMARY :

Average initial stress (after release).....	1257.87	N/mm ²
Long term stress losses	227.00	N/mm ²
Final average stress	1030.87	N/mm ²
Final average force in tendon	98582.03	N
Anchor set influence from left pull (1292.90N/mm ² ; .695)	35.45	mm
Anchor set influence from right pull (1298.27N/mm ² ; .698)	37.43	mm
Elongation at left pull before anchor set	590.	mm
Elongation at right pull before anchor set	40.	mm
Elongation at left pull after anchor set	574.	mm
Elongation at right pull after anchor set	24.	mm
Total elongation after anchor set	598.	mm
Ratio of total elongation to tendon length after anchor set	6.	mm/m
Jacking force	133475.57	N

CRITICAL STRESS RATIOS :

At stressing .75; At anchorage .65; Max along tendon .70

5.2.2 Beam Example From Adapt Post-Tensioning Software

The following is a friction and long-term stress loss calculation for the beam example given in Chapter 5 of ADAPT post-tensioning software manual. The tendon profile is a combination of simple parabola with straight lengths over the supports and an inverted parabola in the third span. The overall dimensions of the beam are shown on the following page. Tables of the horizontal and vertical distances to the critical points of the tendons are reproduced below from the ADAPT output.

Note that in the preparation of data the modulus of elasticity of concrete at stressing is entered as 21525 N/mm². This is obtained by using the ACI relationship of $E_{ci} = 57 \cdot (20.68)^{1/2}$, for f'_{ci} equal to 20.68 N/mm² at stressing.

```

===== EXCERPT FROM ADAPT OUTPUT =====

9.1 PROFILE TYPES AND PARAMETERS
LEGEND:
1 = reversed parabola
2 = simple parabola with straight portion over support
3 = harped tendon

9.2 TENDON PARAMETERS
      TYPE  X1/L  X2/L  X3/L  A/L
-----1-----2-----3-----4-----5-----
1      2      .015  .500  .030  .000
2      2      .035  .500  .000  .000
3      2      .000  .500  .060  .000

      <---- 9.3 SELECTED VALUES ---->   <-- 9.4 CALCULATED VALUES -->
      FORCE *-<-DISTANCE OF CGS mm ->      P/A      Wbal      TOTAL FORCE
SPAN  (kN/-)  Left  Center  Right  (N/mm^2)  (kN/-)  (kN)
-----1-----2-----3-----4-----5-----6-----7-----8-----
1     1430.00  595   80     844   2.17     19.215  1430.00
2     925.00   844   80     844   1.40     20.299  925.00
3     925.00   844   750   595   1.40     -12.156  925.00

* ALL distances are heights from soffit of respective member at mid-span
Approximate weight of strand ..... 361.6 KG
=====
    
```

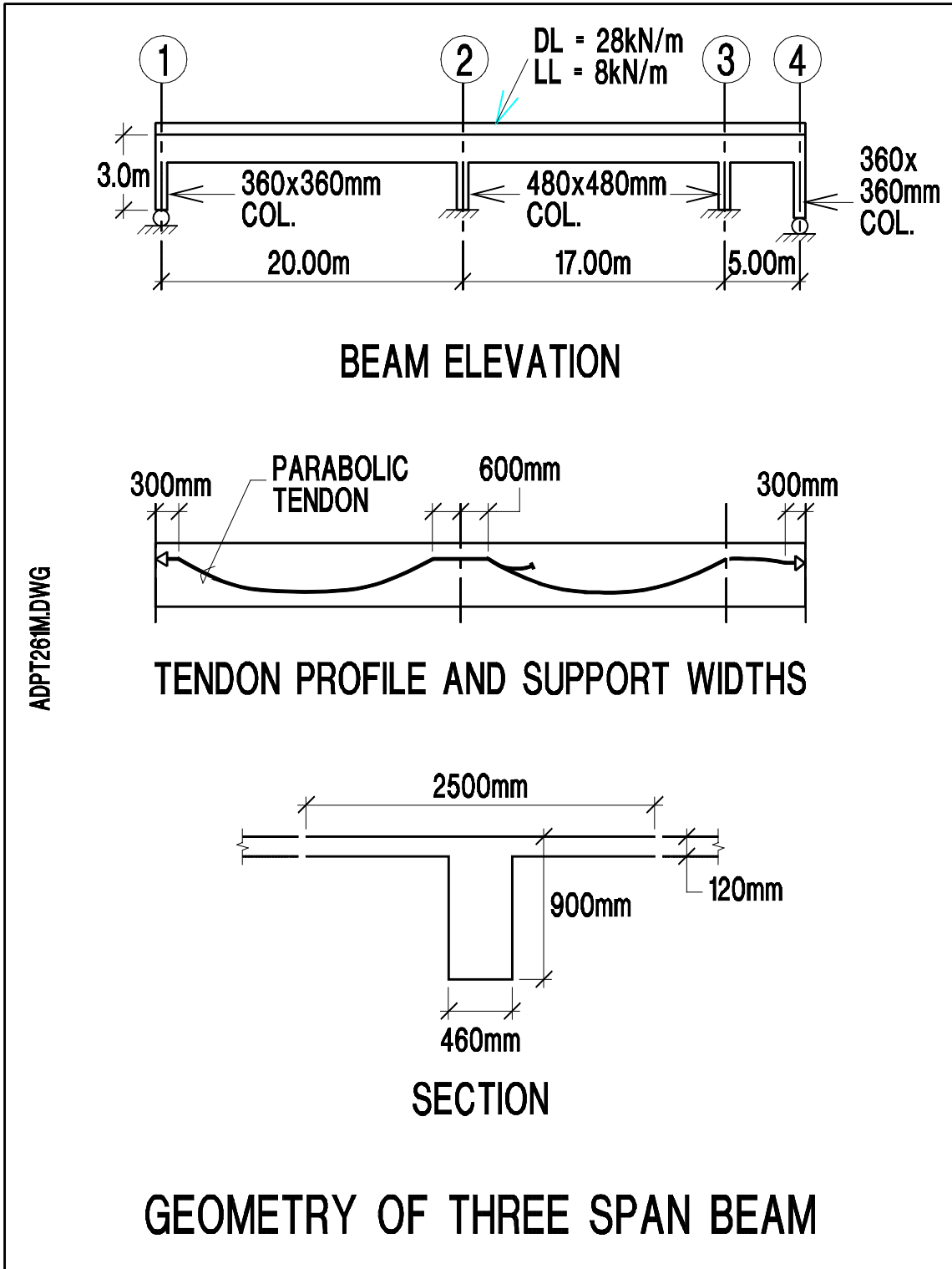

FIGURE 5.2-3

ADAPT Corporation, Redwood City, CA, USA
 ADAPT International Pvt. Ltd., Kolkata, India
 ADAPT Latin America, Miami, FL, USA
 support@adaptsoft.com, www.adaptsoft.com

ADAPT-FELT Standard 2011
 ADAPT POST-TENSIONING STRESS LOSS & ELONGATION PROGRAM
 This program calculates the long-term and immediate stress losses in a post-tensioned tendon. It outputs the elongations at the stressing ends and the final stress profile along the tendon.

DATE: Jan 5, 2011

TIME: 17:28:55

P R O J E C T T I T L E :
 LONG-TERM & FRICTION LOSSES, ADAPT BEAM EXAMPLE

S P E C I F I C T I T L E :
 LOSM-EX3

L O N G - T E R M L O S S C A L C U L A T I O N S :

INPUT PARAMETERS :

Post-tensioning system	UNBONDED	
Type of strand	LOW LAX	
Ultimate strength of strand	1861.00	N/mm ²
Modulus of elasticity of strand	193000.00	N/mm ²
Estimate of initial average compression	1.40	N/mm ²
Concrete strength at 28 days	27.58	N/mm ²
Average weight of concrete	NORMAL	
Estimated age of concrete at stressing	4	days
Modulus of elasticity of concrete at stressing	21520.00	N/mm ²
Modulus of elasticity of concrete at 28 days	24680.00	N/mm ²
Estimate of average relative humidity	70.	%
Volume to surface ratio of member	101.10	mm

CALCULATED VALUES :

Elastic shortening	6.28	N/mm ²
Shrinkage	29.81	N/mm ²
Creep	17.52	N/mm ²
Relaxation	25.86	N/mm ²

Total long-term stress losses	79.47	N/mm ²

F R I C T I O N & E L O N G A T I O N C A L C U L A T I O N S :

INPUT PARAMETERS :

Coefficient of angular friction (meu).....	.08000	/radian
Coefficient of wobble friction (K).....	.00590	rad/m
Ultimate strength of strand	1861.00	N/mm ²
Ratio of jacking stress to strand's ultimate strength	.80	
Anchor set	6.00	mm
Cross-sectional area of strand	95.630	mm ²
Total Number of Strands per Tendon.....	1	
STRESSING	AT BOTH ENDS	

LEGEND :

P = Tendon profile type defined as: 1=reversed parabola;
 2=partial/regular parabola; 3=harped; 4=general
 X1/L etc = horizontal distances to control points in geometry of the
 tendon divided by span length
 Stresses tabulated are after anchor set but before long-term losses.

TENDON ID, GEOMETRY AND STRESS PROFILE (LOSM-EX3)

SPAN	m	P	< TENDON HEIGHT mm.>			Horizontal ratios			<- STRESS (N/mm ²)->		
			start	center	right	X1/L	X2/L	X3/L	start	center	right
-1----	2-----	3----	4-----	5-----	6-----	7-----	8-----	9-----	10-----	11-----	12-
1	19.50	2	577.0	83.0	806.0	.03	.50	.03	1272.52	1363.27	1299.25
2	16.76	2	806.0	254.0	806.0	.04	.50	.00	1268.06	1312.65	1291.45
3	5.18	2	806.0	711.0	577.0	.00	.50	.06	1291.45	1261.74	1218.97

			41.44 m (total length of tendon)								

SUMMARY :

Average initial stress (after release).....	1308.68	N/mm ²
Long term stress losses	79.47	N/mm ²
Final average stress	1229.22	N/mm ²
Final average force in tendon	117550.04	N
Anchor set influence from left pull (1373.90N/mm ² ; .738)	10.84	m
Anchor set influence from right pull (1352.75N/mm ² ; .727)	9.35	m
Elongation at left pull before anchor set	273.	mm
Elongation at right pull before anchor set	20.	mm
Elongation at left pull after anchor set	267.	mm
Elongation at right pull after anchor set	14.	mm
Total elongation after anchor set	281.	mm
Ratio of total elongation to tendon length after anchor set	7.	mm/m
Jacking force	142373.94	N

CRITICAL STRESS RATIOS :

At stressing .80; At anchorage .68; Max along tendon .74

5.2.3 Circular Water Tank Example - General Profile

This example demonstrates the use of the general tendon profile. Consider a circular cylindrical tank prestressed with horizontal grouted tendons.

Figure 5.2-4 shows the arrangement of tendons. Each tendon covers one-half of the perimeter. It is straight at the ends with stressing details as shown in part b of the figure. Coefficients of the angular and wobble friction are $0.3/\text{radian}$ and $0.0007/\text{m}$ respectively. A lump sum stress loss of 172 N/mm^2 is specified. It is required to determine the stress distribution and the effective final stress in tendon.

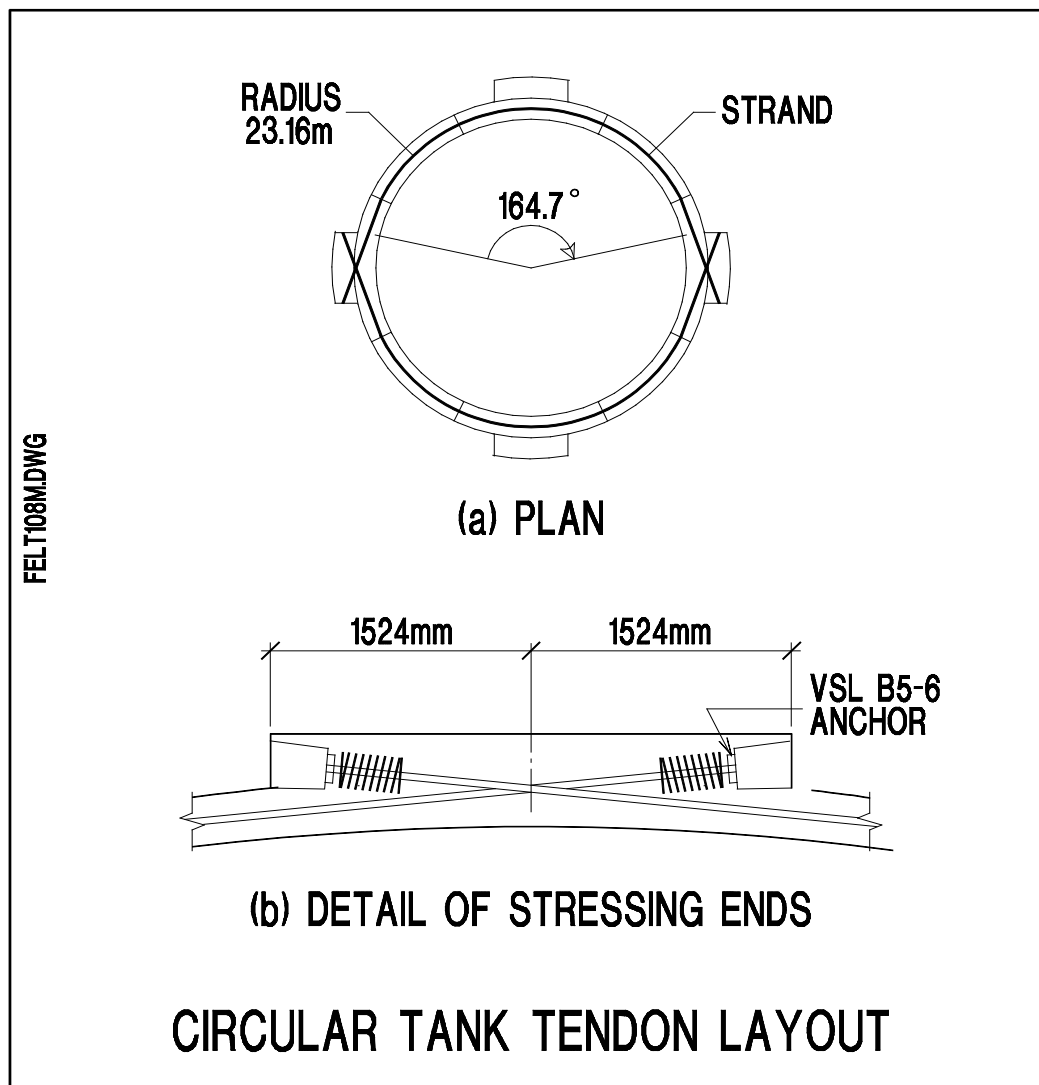

FIGURE 5.2-4

To approximate the curved portion the tendon of span 2 is broken into nine segments using tendon type 4 in the input. This tendon type allows the user to specify the endpoint coordinates of each segment and the angle change at the right end of each segment. Note that the last segment in span 2 is assigned a zero angle change. This is done to get a symmetrical answer since the angle change is always on the right end of each segment. Spans 1 and 3 represent the straight segments at each anchorage. Keep in mind, the more segments and angle changes are specified the closer will be the results to the actual condition.

```

-----
                        ADAPT CORPORATION
1733 Woodside Road, Suite 220, Redwood City, CA 94061 USA
Tel: (650) 306 2400, Fax: (650) 364 4678
E-mail: support@adaptsoft.com, Web site: www.adaptsoft.com
-----
                        ADAPT-FELT Standard 4.06
ADAPT POST-TENSIONING STRESS LOSS & ELONGATION PROGRAM
LICENSED TO: ADAPT CORPORATION, CA
-----
This program calculates the long-term and immediate stress losses in a post-
tensioned tendon. It outputs the elongations at the stressing ends and the
final stress profile along the tendon.
-----
DATE: Mar 27, 2001                                     TIME: 08:46:17

P R O J E C T   T I T L E   :
CRESTVIEW WATER TANK FRICTION AND ELONGATION CALCS

S P E C I F I C   T I T L E   :
(LOSM-EX8)

L O N G - T E R M   L O S S   C A L C U L A T I O N S   :

INPUT PARAMETERS :

Long-term stress losses due to shrinkage, creep, elastic
shortening and stress-relaxation are estimated to a
total lump sum of ..... 172.00 N/mm^2

```

F R I C T I O N & E L O N G A T I O N C A L C U L A T I O N S :

INPUT PARAMETERS :

Coefficient of angular friction (meu).....	.30000	/radian
Coefficient of wobble friction (K).....	.00070	rad/m
Ultimate strength of strand	1861.00	N/mm ²
Ratio of jacking stress to strand's ultimate strength	.80	
Anchor set00	mm
Cross-sectional area of strand	95.630	mm ²
Total Number of Strands per Tendon.....	1	
Modulus of elasticity of strand	193000.00	N/mm ²
STRESSING		AT BOTH ENDS

LEGEND :

P = Tendon profile type defined as: 1=reversed parabola;
 2=partial/regular parabola; 3=harped; 4=general
 X1/L etc = horizontal distances to control points in geometry of the
 tendon divided by span length
 Stresses tabulated are after anchor set but before long-term losses.

TENDON ID, GEOMETRY AND STRESS PROFILE (LOSM-EX8)

LENGTH		< TENDON HEIGHT mm.>			Horizontal ratios			<- STRESS (N/mm ²)->			
SPAN	m	P	start	center	right	X1/L	X2/L	X3/L	start	center	right
-1----	2-----	3----	4-----	5-----	6-----	7-----	8-----	9-----	10-----	11-----	12-
1	3.05	4	(angle changes = .0)						1488.80	1487.21	1485.62
2	69.75	4	(angle changes = 146.4)						1485.62	988.41	1485.62
3	3.05	4	(angle changes = .0)						1485.62	1487.21	1488.80

	75.85 m	(total length of tendon)									

SUMMARY :

Average initial stress (after release).....	1241.81	N/mm ²
Long term stress losses	172.00	N/mm ²
Final average stress	1069.81	N/mm ²
Final average force in tendon	102305.94	N
Anchor set influence from left pull (1488.80N/mm ² ; .800)	.00	m
Anchor set influence from right pull (1488.80N/mm ² ; .800)	.00	m
Elongation at left pull before anchor set	401.	mm
Elongation at right pull before anchor set	87.	mm
Elongation at left pull after anchor set	401.	mm
Elongation at right pull after anchor set	87.	mm
Total elongation after anchor set	488.	mm
Ratio of total elongation to tendon length after anchor set	6.434249	mm/m
Jacking force	142373.94	N

CRITICAL STRESS RATIOS :

At stressing .800; At anchorage .800; Max along tendon .800

DETAIL OF STRESSES AT 1/20TH POINTS ALONG EACH SPAN

Units are in N/mm²

X/L	Span 1	Span 2	Span 3
.00	1488.80	1485.62	1485.62
.05	1488.64	1426.30	1485.78
.10	1488.48	1369.35	1485.94
.15	1488.32	1314.67	1486.10
.20	1488.16	1262.18	1486.26
.25	1488.01	1211.78	1486.42
.30	1487.85	1163.39	1486.58
.35	1487.69	1116.94	1486.74
.40	1487.53	1072.34	1486.89
.45	1487.37	1029.52	1487.05
.50	1487.21	988.41	1487.21
.55	1487.05	1029.52	1487.37
.60	1486.89	1072.34	1487.53
.65	1486.74	1116.94	1487.69
.70	1486.58	1163.39	1487.85
.75	1486.42	1211.78	1488.01
.80	1486.26	1262.18	1488.16
.85	1486.10	1314.67	1488.32
.90	1485.94	1369.35	1488.48
.95	1485.78	1426.30	1488.64
1.00	1485.62	1485.62	1488.80

TENDON HEIGHT AT 1/20TH POINTS ALONG EACH SPAN

Units are in mm

X/L	Span 1	Span 2	Span 3
.00	0.	0.	0.
.05	0.	0.	0.
.10	0.	0.	0.
.15	0.	0.	0.
.20	0.	0.	0.
.25	0.	0.	0.
.30	0.	0.	0.
.35	0.	0.	0.
.40	0.	0.	0.
.45	0.	0.	0.
.50	0.	0.	0.
.55	0.	0.	0.
.60	0.	0.	0.
.65	0.	0.	0.
.70	0.	0.	0.
.75	0.	0.	0.
.80	0.	0.	0.
.85	0.	0.	0.
.90	0.	0.	0.
.95	0.	0.	0.
1.00	0.	0.	0.

DETAILED POLYLINE INFORMATION					
SPAN	LENGTH (m)	TYPE	X (m)	Y (mm)	BETA degree
1	3.05	4	.00 3.05	.00 .00	.00 .00
2	69.75	4	.00 7.75 15.50 23.25 31.00 38.75 46.50 54.25 62.00 69.75	.00 .00 .00 .00 .00 .00 .00 .00 .00 .00	.00 18.30 18.30 18.30 18.30 18.30 18.30 18.30 18.30 18.30 .00
3	3.05	4	.00 3.05	.00 .00	.00 .00

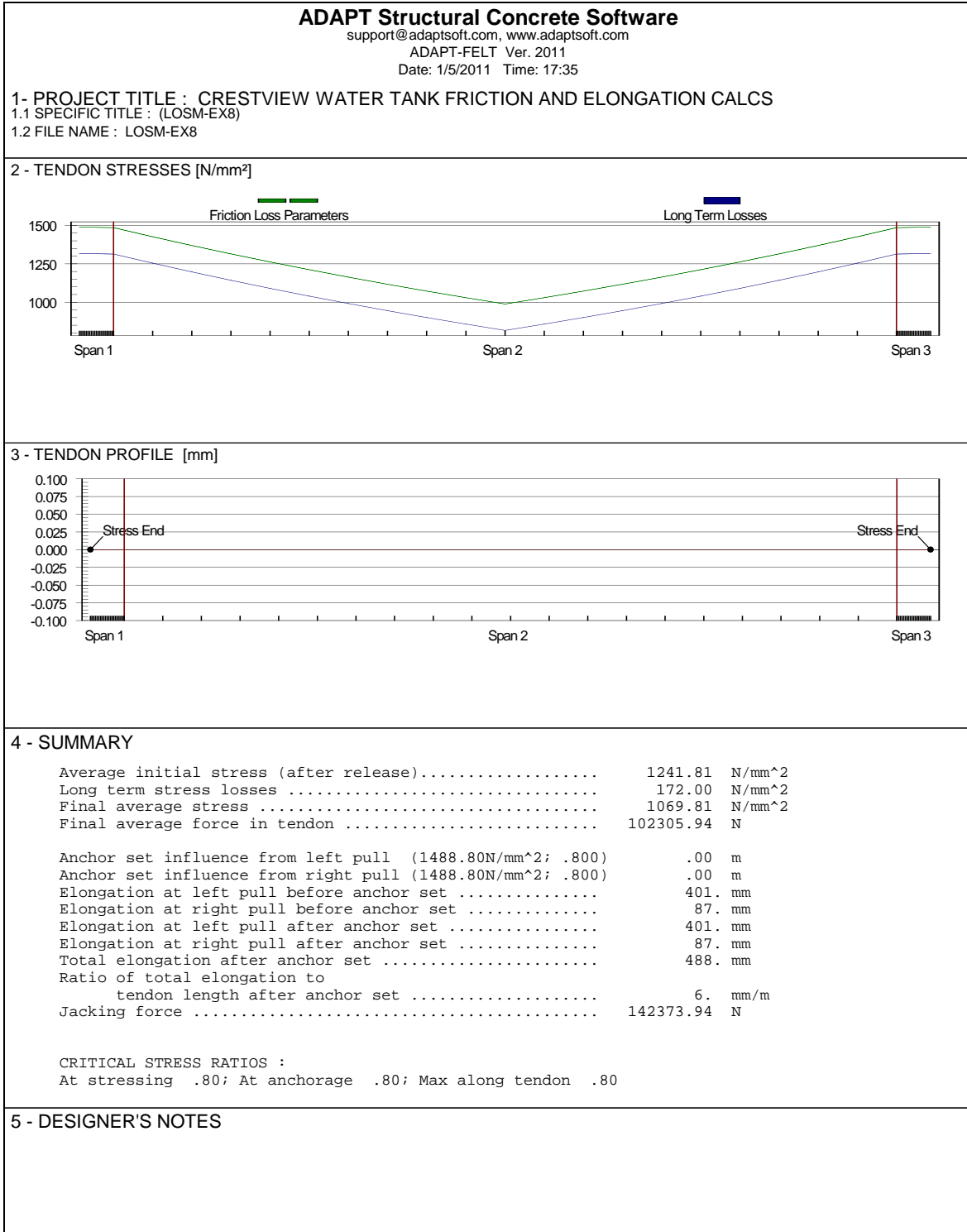

FIGURE 5.2-5

Chapter 6

VERIFICATION AND ADDITIONAL EXAMPLES

6.1	VERIFICATION OF FRICTION LOSS CALCULATIONS	91
6.2	LONG-TERM LOSS COMPUTATIONS FOR UNBONDED TENDONS.....	96
6.3	LONG-TERM LOSS CALCULATIONS FOR GROUTED TENDONS.....	99
6.3.1	Calculation of Initial Stress in Tendon	101
6.3.2	Bending Moments and Stresses at Required Points.....	101
6.3.3	Calculation of Long-term Stress Losses	103
	A. At mid-span	103
	B. At second support	105
6.4	LONG-TERM STRESS LOSS CALCULATIONS FOR A PRECAST BEAM .	112
6.5	LONG-TERM STRESS LOSS FOR A PRECAST PILE.....	117

This Page Left Intentionally

BLANK

6.1 VERIFICATION OF FRICTION LOSS CALCULATIONS

A friction loss calculation is conducted for the example given in *Recommendations for Estimating Prestress Losses*, PCI Journal, July-August 1975, pp. 44-75. The layout of the slab and the actual geometry of the tendons are shown in **Figure 6.1-1(a)** and **(b)**. The calculations carried out in PCI example and ADAPT-FELT both relate to the actual geometry shown **Figure 6.1-1(b)** with the critical tendon heights as given in **Figure 6.1-1(c)**.

The jacking stress, tendon material and friction parameters are reflected as input data in the computer printout. The agreement between the two solutions is very good. Values given in the PCI example are listed with those obtained by ADAPT-FELT in **Table 6.1-1**. The item numbers in the table are entered as bubbled numbers in the ADAPT-FELT printout for quick reference.

**TABLE 6.1-1 COMPARISON OF RESULTS BETWEEN
PCI EXAMPLE AND FELT**

ITEM	DESCRIPTION	PCI	FELT
1	Average initial stress (N/mm ²)	1260	1264.97
2	Anchor set influence (mm)	7772	7820
3	Maximum initial stress (N/mm ²)	1307	1309.13
4	Anchoring stress (N/mm ²)	1236	1241.11
5	Stress at mid-span (N/mm ²)	1202	1212.53
6	Total elongation (mm)	*	231.605

*PCI example does not calculate the elongations.

The accuracy of the total elongation can be verified as follows:

$$\begin{aligned} \text{Elongation} &= (\text{average stress}) * (\text{length of tendon}) / E_s \\ &= 1258 * (36576) / 199948 = 230 \text{ mm} \quad \text{OK} \end{aligned}$$

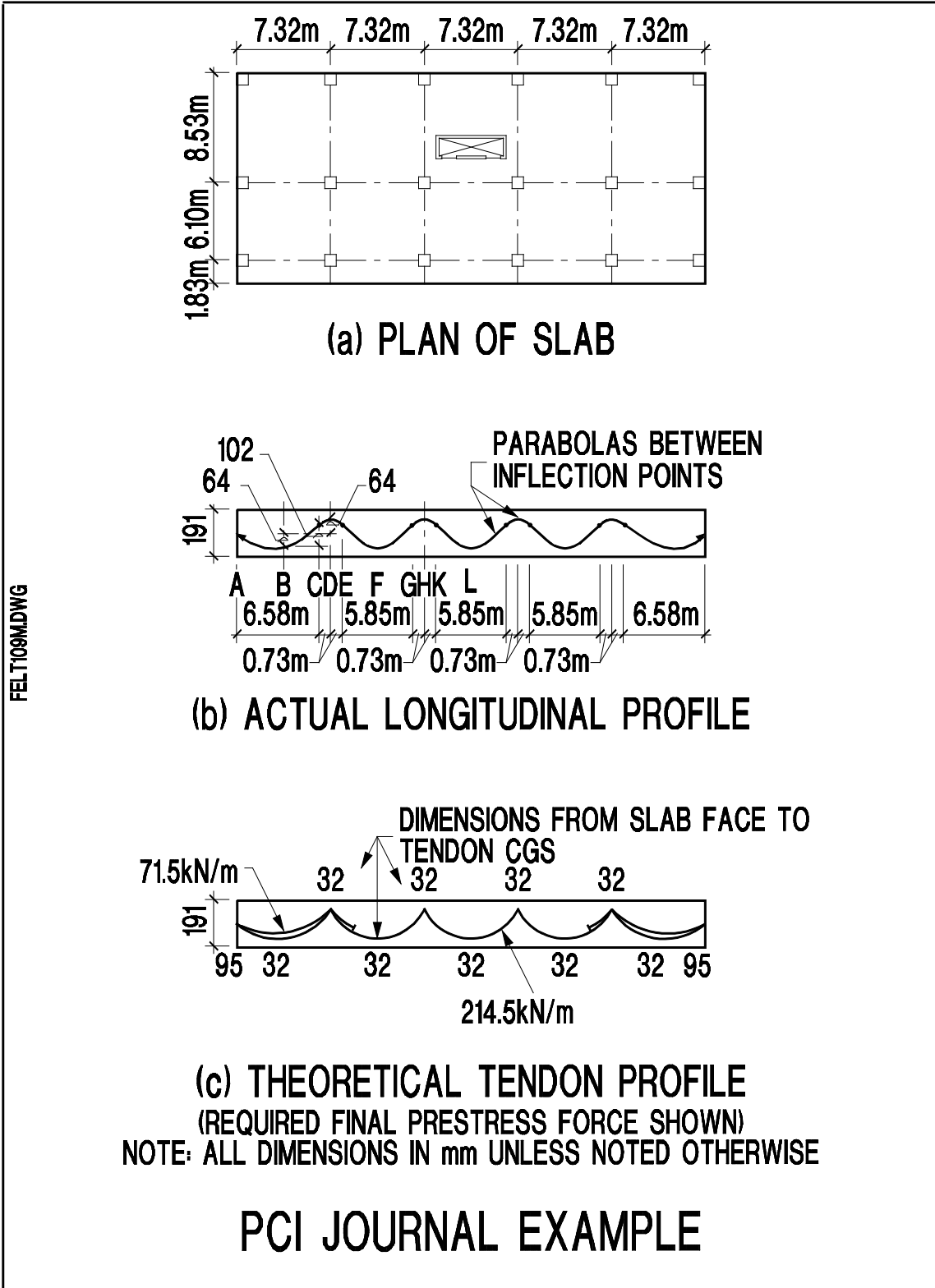

FIGURE 6.1-1

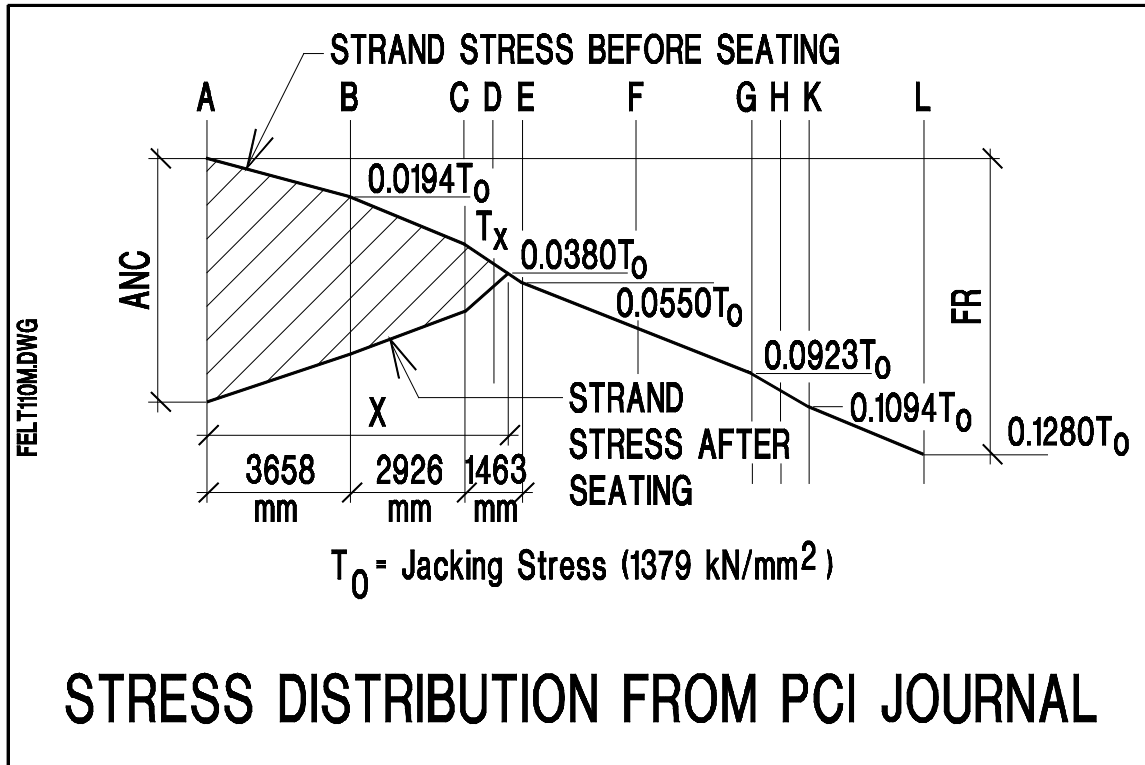

FIGURE 6.1-2

```

-----
ADAPT Corporation, Redwood City, CA, USA
ADAPT International Pvt. Ltd., Kolkata, India
ADAPT Latin America, Miami, FL, USA
support@adaptsoft.com, www.adaptsoft.com
-----

```

```

-----
ADAPT-FELT Standard 2011
ADAPT POST-TENSIONING STRESS LOSS & ELONGATION PROGRAM
This program calculates the long-term and immediate stress losses in a post-
tensioned tendon. It outputs the elongations at the stressing ends and the
final stress profile along the tendon.
-----

```

DATE: Jan 5, 2011

TIME: 17:48:37

PROJECT TITLE :
 FRICTION AND LONG-TERM LOSS EXAMPLE OF A SLAB

SPECIFIC TITLE :
 PCI JURNAL EXAMPLE

LONG - TERM LOSS CALCULATIONS :

INPUT PARAMETERS :

Post-tensioning system	UNBONDED	
Type of strand	STRESS RELIEVED	
Ultimate strength of strand	1861.00	N/mm ²
Modulus of elasticity of strand	199900.00	N/mm ²
Estimate of initial average compression	1.12	N/mm ²
Concrete strength at 28 days	27.50	N/mm ²
Average weight of concrete	NORMAL	
Estimated age of concrete at stressing	7	days
Modulus of elasticity of concrete at stressing	12420.00	N/mm ²
Modulus of elasticity of concrete at 28 days	24650.00	N/mm ²
Estimate of average relative humidity	70.	%
Volume to surface ratio of member	95.25	mm

CALCULATED VALUES :

Elastic shortening	9.01	N/mm ²
Shrinkage	29.35	N/mm ²
Creep	14.53	N/mm ²
Relaxation	115.63	N/mm ²

Total long-term stress losses	168.52	N/mm ²

FRICTION & ELONGATION CALCULATIONS :

INPUT PARAMETERS :

Coefficient of angular friction (meu)..... .08000 /radian
 Coefficient of wobble friction (K)..... .00460 rad/m
 Ultimate strength of strand 1861.00 N/mm²
 Ratio of jacking stress to strand's ultimate strength .74
 Anchor set 3.00 mm
 Cross-sectional area of strand 95.630 mm²
 Total Number of Strands per Tendon..... 1
 STRESSING AT BOTH ENDS

LEGEND :

P = Tendon profile type defined as: 1=reversed parabola;
 2=partial/regular parabola; 3=harped; 4=general
 X1/L etc = horizontal distances to control points in geometry of the
 tendon divided by span length
 Stresses tabulated are after anchor set but before long-term losses.

TENDON ID, GEOMETRY AND STRESS PROFILE (PCIM-5SP)

SPAN	m	P	< TENDON HEIGHT mm.>			Horizontal ratios			<- STRESS (N/mm ²)->																																																												
			start	center	right	X1/L	X2/L	X3/L	start	center	right																																																										
-1	----	2	----	3	----	4	----	5	----	6	----	7	----	8	----	9	----	10	----	11	----	12																																															
1	7.32	1	8.0	32.0	159.0	.00	.50	.10	1241.11	1266.73	1301.14	}	4	2	7.32	1	159.0	32.0	159.0	.10	.50	.10	1301.14	1280.40	1247.30	}	5	3	7.32	1	159.0	32.0	159.0	.10	.50	.10	1247.30	1212.53	1247.30	}	1	4	7.32	1	159.0	32.0	159.0	.10	.50	.10	1247.30	1280.40	1301.14	}	2	5	7.32	1	159.0	32.0	8.0	.10	.50	.00	1301.14	1266.73	1241.11	}	6
-----														36.60 m (total length of tendon)																																																							

SUMMARY :

Average initial stress (after release)..... 1264.97 N/mm²
 Long term stress losses 168.52 N/mm²
 Final average stress 1096.45 N/mm²
 Final average force in tendon 104853.10 N
 Anchor set influence from left pull (1309.13N/mm²; .703) 7.82 m
 Anchor set influence from right pull (1309.13N/mm²; .703) 7.82 m
 Elongation at left pull before anchor set 223. mm
 Elongation at right pull before anchor set 15. mm
 Elongation at left pull after anchor set 220. mm
 Elongation at right pull after anchor set 12. mm
 Total elongation after anchor set 232. mm
 Ratio of total elongation to tendon length after anchor set 6. mm/m
 Jacking force 131695.90 N

CRITICAL STRESS RATIOS :

At stressing .74; At anchorage .67; Max along tendon .70

6.2 LONG-TERM LOSS COMPUTATIONS FOR UNBONDED TENDONS

Consider the example used in Section 3 of the manual, the printout of which is reproduced and marked up herein for quick reference. Numbers shown in parentheses are cross referenced with bubbled numbers in the printout.

Elastic Shortening:

$$ES = K_{es} * (E_s / E_{ci}) * f_{cpa}$$

$$f_{cpa} = 1.38 \text{ N/mm}^2 \quad (1)$$

$$E_{ci} = 11420 \text{ N/mm}^2 \quad (2)$$

$$E_s = 193000 \text{ N/mm}^2 \quad (3)$$

$$ES = 0.5 * (193000 / 11420) * 1.38 = 11.661 \text{ N/mm}^2 \quad (4)$$

Shrinkage of Concrete:

$$SH = 8.2 * 10^{-6} * K_{sh} * E_s * [1 - 0.00236 * (V/S)] * (100 - RH)$$

$$V/S = 93.73 \text{ mm} \quad (5)$$

$$RH = 80 \% \quad (6)$$

$$K_{sh} = 0.5(0.8 + 0.77) = 0.785 \text{ (from Table 4.3-1 for 6 days)} \quad (7)$$

$$SH = 8.2 * 10^{-6} * 0.785 * 193000 * (1 - 0.00236 * 93.73) * (100 - 80) / 1000 = 19.346 \text{ N/mm}^2 \quad (8)$$

Creep of Concrete:

$$CR = K_{cr} * (E_s / E_c) * f_{cpa}$$

$$E_c = 24680 \text{ N/mm}^2 \quad (9)$$

$$CR = 1.6 * (193000 / 24680) * 1.38 = 17.267 \text{ N/mm}^2 \quad (10)$$

Relaxation of Strands:

$$RE = [K_{re} - J * (SH + CR + ES)] * C$$

For 270 ksi low relaxation strand, from **Table 4.3-2**:

$$K_{re} = 34.47$$

$$J = 0.04$$

$$f_{pi} = 1281.14 \text{ N/mm}^2 \tag{11}$$

$$f_{pu} = 1861 \text{ N/mm}^2 \tag{12}$$

$$f_{pi}/f_{pu} = 1281.14/1861 = 0.6884$$

From **Table 4.3-3**: $C = 0.70$ (Note that FELT conservatively selects the next higher value of stress relaxation constant.)

$$\begin{aligned} RE &= [34.47 - 0.04*(19.346 + 17.267 + 11.661)]*0.70 \\ &= 24.777 \text{ N/mm}^2 \quad (\text{FELT } 22.773) \end{aligned} \tag{13}$$

$$\begin{aligned} \text{Total Stress Losses} &= 11.661 + 19.346 + 17.267 + 22.777 \\ &= 71.051 \text{ N/mm}^2 \quad (\text{FELT } 71.046) \end{aligned} \tag{14}$$

```

-----
ADAPT Corporation, Redwood City, CA, USA
ADAPT International Pvt. Ltd., Kolkata, India
ADAPT Latin America, Miami, FL, USA
support@adaptsoft.com, www.adaptsoft.com
-----
ADAPT-FELT Standard 2011
ADAPT POST-TENSIONING STRESS LOSS & ELONGATION PROGRAM
This program calculates the long-term and immediate stress losses in a post-
tensioned tendon. It outputs the elongations at the stressing ends and the
final stress profile along the tendon.
-----
DATE: Jan 5, 2011                                TIME: 12:05:04

PROJECT TITLE :
STRESS LOSS EXAMPLE

SPECIFIC TITLE :
(LOSM-EX1)

LONG-TERM LOSS CALCULATIONS :

INPUT PARAMETERS :
Post-tensioning system ..... UNBONDED
Type of strand ..... LOW LAX [12]
Ultimate strength of strand ..... 1861.00 N/mm^2 [3]
Modulus of elasticity of strand ..... 193000.00 N/mm^2
Estimate of initial average compression ..... 1.38 N/mm^2 [1]

Concrete strength at 28 days ..... 27.58 N/mm^2
Average weight of concrete ..... NORMAL
Estimated age of concrete at stressing ..... 6 days [7] [2]
Modulus of elasticity of concrete at stressing ..... 11420.00 N/mm^2 [9]
Modulus of elasticity of concrete at 28 days ..... 24680.00 N/mm^2
Estimate of average relative humidity ..... 80. % [6]
Volume to surface ratio of member ..... 93.73 mm [5]

CALCULATED VALUES :
Elastic shortening ..... 11.66 N/mm^2 [8]
Shrinkage ..... 19.35 N/mm^2 [10]
Creep ..... 17.27 N/mm^2 [13]
Relaxation ..... 22.77 N/mm^2 [14]
-----
Total long-term stress losses ..... 71.05 N/mm^2
    
```

FR I C T I O N & E L O N G A T I O N C A L C U L A T I O N S :

INPUT PARAMETERS :

Coefficient of angular friction (meu)..... .07000 /radian
 Coefficient of wobble friction (K)..... .00420 rad/m
 Ultimate strength of strand 1861.00 N/mm²
 Ratio of jacking stress to strand's ultimate strength .80
 Anchor set 6.00 mm
 Cross-sectional area of strand 95.630 mm²
 Total Number of Strands per Tendon..... 1
 STRESSING AT BOTH ENDS

LEGEND :

P = Tendon profile type defined as: 1=reversed parabola;
 2=partial/regular parabola; 3=harped; 4=general
 X1/L etc = horizontal distances to control points in geometry of the
 tendon divided by span length
 Stresses tabulated are after anchor set but before long-term losses.

TENDON ID, GEOMETRY AND STRESS PROFILE (LOSM-EX1)

SPAN	m	P	< TENDON HEIGHT mm.>			Horizontal ratios			<- STRESS (N/mm ²)->														
			start	center	right	X1/L	X2/L	X3/L	start	center	right												
-1	----	2	----	3	----	4	----	5	----	6	----	7	----	8	----	9	----	10	----	11	----	12	
CAN	2.44	3	646.0		762.0			.13			1276.63												1289.63
1	18.29	3	857.0	57.0	857.0	.05	.33	.05			1303.14	1365.10											1326.73
2	15.24	1	857.0	57.0	857.0	.05	.50	.05			1314.98	1240.14											1176.24
3	12.19	2	857.0	102.0	857.0	.05	.50	.00			1164.67	1206.31											1299.25
4	12.19	2	857.0	57.0	857.0	.00	.50	.00			1299.25	1334.87											1235.56
CAN	2.44	1	857.0		646.0	.00					1235.56												1203.25

 62.79 m (total length of tendon)

SUMMARY :

Average initial stress (after release)..... 1280.14 N/mm²
 Long term stress losses 71.05 N/mm²
 Final average stress 1209.10 N/mm²
 Final average force in tendon 115625.96 N

Anchor set influence from left pull (1382.71N/mm²; .743) 9.99 m
 Anchor set influence from right pull (1346.03N/mm²; .723) 9.68 m
 Elongation at left pull before anchor set 391. mm
 Elongation at right pull before anchor set 38. mm
 Elongation at left pull after anchor set 385. mm
 Elongation at right pull after anchor set 32. mm
 Total elongation after anchor set 416. mm
 Ratio of total elongation to tendon length after anchor set 7. mm/m
 Jacking force 142373.94 N

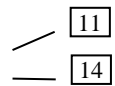

CRITICAL STRESS RATIOS :

At stressing .80; At anchorage .69; Max along tendon .74

6.3 LONG-TERM LOSS CALCULATIONS FOR GROUTED TENDONS

A two span beam with grouted post-tensioning is shown in **Figure 6.3-1**. It is required to determine the final effective forces at mid-point of the first span and over the second support.

The effective or *design force* is the initial force minus friction and long-term stress losses. Because the long-term losses at any point are a function of stresses at that point, and because the stresses vary along the beam, for the two locations specified the stresses must be calculated separately. In many instances it is possible to select representative stress conditions for critical locations of a structural member and perform one long-term stress loss calculation for the entire beam. In this example, however, the strict method is adopted.

Given:

Selfweight of beam for 5.49 m tributary	24.37 kN/m
Superimposed sustained load in addition to selfweight after the beam is placed in service (0.83 N/mm ²)	2.63 kN/m
Concrete strength	27.58 N/mm ²
Concrete strength at stressing	20.68 N/mm ²

Post-tensioning is provided by a single tendon consisting of 10 - 11 mm diameter 1861 N/mm² low-relaxation strands stressed at both ends to 0.75 f_{pu} (1396 N/mm²). The stressing is performed three days after the girder is cast. It is achieved by a multistrand ram with all 10 strands pulled at the same time. Anchor set is 6.4 mm. The geometry of tendon consists of simple and reversed parabolic portions with the heights at the critical points as shown in **Figure 6.3-1**. The modulus of elasticity of strand is 193000 N/mm².

The friction characteristics of the duct used are:

Coefficient of angular friction	μ	= 0.25/radian
Coefficient of wobble friction	K	= 0.061/mm

Required:

Design stress at mid-length of first span and over the second support.

Verification:

The verification consists of the following steps:

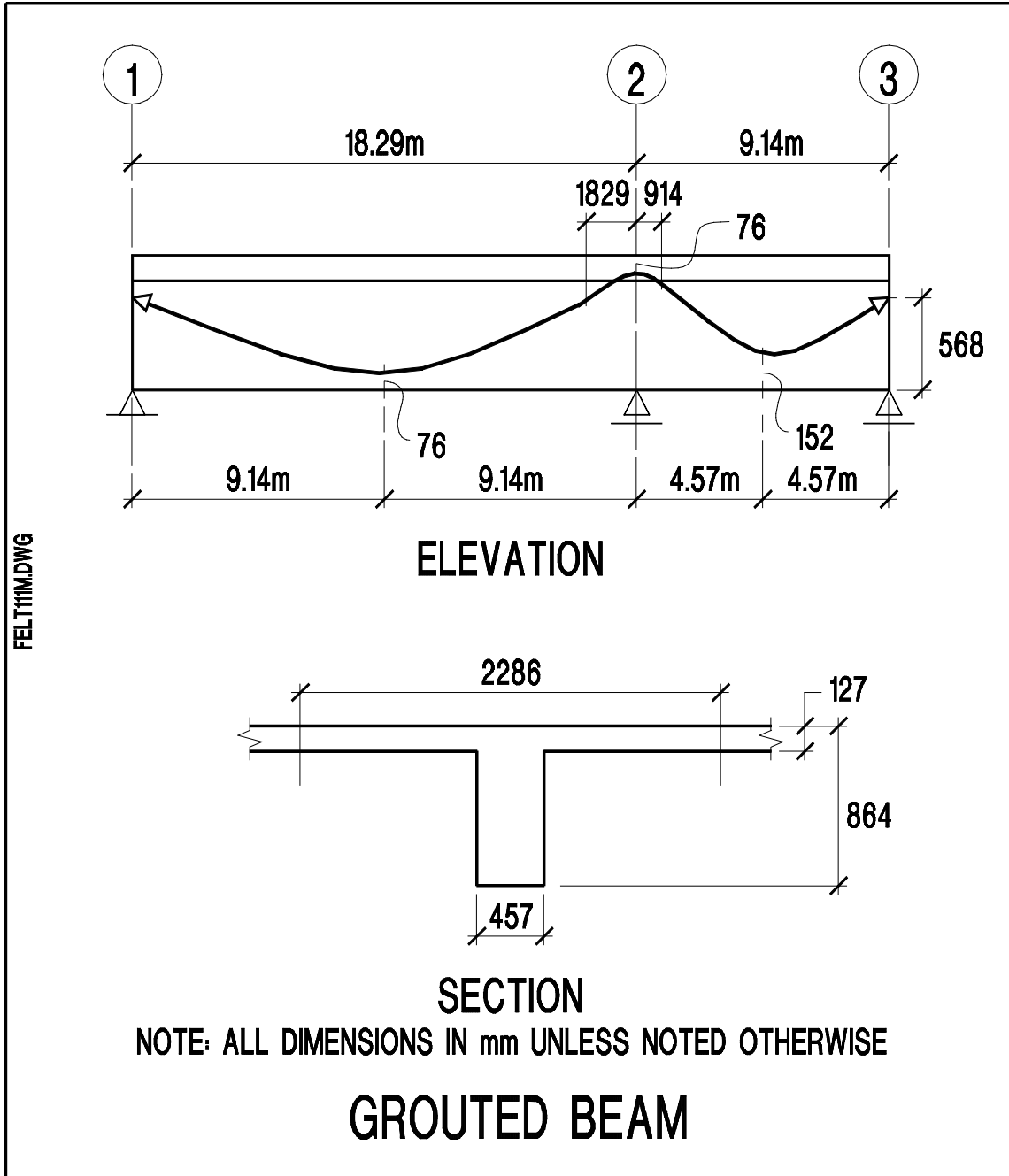

FIGURE 6.3-1

1 - Determine the initial stress in tendon at midspan and over second support. Use ADAPT-FELT friction program or hand calculations.

2 - Determine the bending moments and stresses at midspan and over the first support due to selfweight and the superimposed sustained loading using ADAPT or other software. Also, calculate stresses due to post-tensioning.

3 - Use the relationships described in this manual or reference (Zia, et al. 1988) to calculate long-term losses.

The long-hand calculations presented are followed by a printout from the ADAPT-FELT for the same example.

6.3.1 Calculation of Initial Stress in Tendon

From the attached printout of ADAPT-FELT, the initial tendon stresses (f_{pi}) after anchor set are:

At midspan	1256.50 N/mm ²
At support	1232.32 N/mm ²

6.3.2 Bending Moments and Stresses at Required Points

The sectional properties of the beam are:

Cross sectional area	A	= 627096 mm ²
Moment of inertia	I	= 4.47*10 ¹⁰ mm ⁴
Neutral axis to bottom fiber	Y _b	= 568.0 mm
Neutral axis to top fiber	Y _t	= 295.0 mm
Neutral axis to height of strand		
At midspan	c	= 568 - 76 = 492.0 mm
At support	c	= 295 - 76 = 219.0 mm

The distribution of bending moments due to selfweight of the beam frame is given in **Table 6.3-1**. These are:

Moment at midspan	636.8 kN-m
Moment at support	-764.3 kN-m

Stresses in concrete at center of gravity of tendons (f_g) due to weight of structure at time of stressing are calculated at height of tendon CGS. This is a hypothetical point for concrete, as in the general case there is no concrete at CGS of tendons. The tendon spanning between the supports, and profiled such as to create an uplift force in the beam, acts against the weight of the beam on formwork.

$$\begin{aligned}\text{Stress } f_g \text{ at midspan} &= 636.8 \cdot (10^6) \cdot 492 / (4.47 \cdot 10^{10}) \\ &= 7.01 \text{ N/mm}^2 \text{ (tension)}\end{aligned}$$

$$\begin{aligned}\text{Stress } f_g \text{ at support} &= 764.3 \cdot (10^6) \cdot 219 / (4.47 \cdot 10^{10}) \\ &= 3.74 \text{ N/mm}^2 \text{ (tension)}\end{aligned}$$

Stresses due to superimposed sustained loading f_{cds} may be prorated from the dead load stresses:

$$\begin{aligned}\text{Stress } f_{cds} \text{ at midspan} &= (2.63/24.37) \cdot 7.01 \\ &= 0.76 \text{ N/mm}^2 \text{ (tension)}\end{aligned}$$

$$\begin{aligned}\text{Stress } f_{cds} \text{ at support} &= (2.63/24.37) \cdot 3.74 \\ &= 0.40 \text{ N/mm}^2 \text{ (tension)}\end{aligned}$$

For the calculation of initial stresses in concrete (f_{ci}) due to post-tensioning, the balanced moments in the beam frame are computed on the basis of an average initial stress in the tendon immediately after release. From the printout of ADAPT-FELT solution this stress is 1264.97 N/mm². Hence,

The average initial post-tensioning force

$$P_{pi} = 10 \cdot 95.630 \cdot 1264.97 = 1209.7 \text{ kN}$$

Due to 1209.7 kN average initial post-tensioning force, the balanced moments may be calculated using a frame program. It should be noted that the balanced loading consists of upward and downward forces consistent with the profile of tendon and its force. For this example, however, the balanced moments are read off from the table of moments at 1/20th points generated by ADAPT (**Table 6.3-2**). The pertinent values are:

$$\begin{aligned}\text{At midspan} \quad M_b &= -406.6 \text{ k-ft} \\ \text{At support} \quad M_b &= 643.8 \text{ k-ft}\end{aligned}$$

Initial concrete stress due to post-tensioning f_{cpi} :

At midspan:

$$\begin{aligned} f_{cpi} &= P_{pi}/A + M_b * c/I \\ &= 1190201/627096 + 406.6*(10^6)*492/(4.47*10^{10}) \\ &= 6.37 \text{ N/mm}^2 \text{ (C)} \end{aligned}$$

At support:

$$\begin{aligned} f_{cpi} &= 1190201/627096 + 643.8*(10^6)*219/(4.47*10^{10}) \\ &= 5.05 \text{ N/mm}^2 \text{ (C)} \end{aligned}$$

6.3.3 Calculation of Long-term Stress Losses

A. At mid-span

(i) Elastic shortening

$$ES = K_{es} * E_s * f_{cir} / E_{ci}$$

$K_{es} = 0$ (all strands are pulled and anchored simultaneously)

$$E_{ci} = 24680 * (3/28)^{1/2} = 8078 \text{ N/mm}^2$$

$$K_{cir} = 1.0$$

$$\begin{aligned} f_{cir} &= K_{cir} * f_{cpi} - f_g \\ &= 1.0 * 6.37 - 7.01 = -0.64 \text{ N/mm}^2 \text{ (T)} \end{aligned}$$

However, considering the fact that at time of stressing the girder is on formwork, and that from the comparison of balanced moment with the hypothetical dead load moment it is apparent that the post-tensioning is not adequate to fully neutralize the dead loading at time of stressing. Therefore f_{cir} may be considered as the average precompression while the girder is on formwork. Hence,

$$f_{cir} = 1190201/627096 = 1.90 \text{ N/mm}^2 \text{ (C)}$$

But, after the formwork is removed it is noted that the mobilization of selfweight results in a net tensile stress of 0.64 N/mm² at CGS of tendon. Therefore, there is no stress loss due to elastic shortening at this location.

$$ES = 0 \text{ psi (FELT 0)}$$

It is observed that, in this example, the long-term losses due to elastic shortening are zero on two grounds. First, because all the strands are stressed and anchored simultaneously ($K_{es} = 0$). Second, because there is no compression at the point of consideration. However, conservatively ADAPT-FELT is coded with $K_{es} = 0.5$ for all cases.

(ii) Creep of concrete

For the calculation of losses due to creep, the initial stress in concrete f_{cir} will be calculated with both the selfweight and the sustained superimposed loadings considered as active. Hence,

$$f_{cir} = 0.64 \text{ N/mm}^2 \text{ (T) from elastic shortening calculations}$$

$$f_{cds} = 0.76 \text{ N/mm}^2 \text{ (T) from stress calculations}$$

$$CR = K_{cr} * (E_s/E_c) * (f_{cir} - f_{cds})$$

$$K_{cr} = 1.6$$

$$E_c = 4700 * (27.58)^{1/2} = 24.680 \text{ N/mm}^2$$

$$(f_{cir} - f_{cds}) = -0.64 - 0.76 = -1.40 \text{ N/mm}^2 \text{ (T)}$$

It is observed that the net stresses ($f_{cir} - f_{cds}$) are tensile. Stress loss due to creep is associated with compressive stresses only. A negative sum is substituted by zero. Therefore,

$$CR = 1.6 * (193000/24680) * 0.0 = 0 \text{ N/mm}^2 \text{ (FELT 0)}$$

(iii) Shrinkage of concrete

The relationship used for shrinkage is:

$$SH = 8.2 * 10^{-6} * K_{sh} * E_s * (1 - 0.0236 * V/S) * (100 - RH)$$

Where,

$$K_{sh} = 0.85 \text{ (for stressing at 3 days - Table 6.3-1)}$$

$$RH = 0.70 \text{ (given relative humidity)}$$

$$\begin{aligned} V/S &= \text{volume to surface ratio} \\ &= (2286 * 127 + 457.2 * 736.6) / (2 * 2286 + 2 * 736.6) \\ &= 103.63 \end{aligned}$$

$$\begin{aligned} SH &= 8.2 \cdot 10^{-6} \cdot 0.85 \cdot 193000 \cdot (1 - 0.00236 \cdot 103.63) \\ &\cdot (100 - 70) \\ &= 30.48 \text{ N/mm}^2 \quad (\text{FELT } 30.480) \end{aligned}$$

(iv) Relaxation of tendon

$$RE = (K_{re} - J \cdot (SH + CR + ES)) \cdot C$$

$$f_{pi} = 1256.5 \text{ N/mm}^2 \text{ (from FELT printout column 11)}$$

$$f_{pi}/f_{pu} = 1256.5/1861 = 0.675$$

$$C = 0.66 \text{ (from Table 4.3-3)}$$

$$K_{re} = 34.47 \text{ N/mm}^2 ; J=0.04 \text{ (from Table 6.3-2)}$$

$$\begin{aligned} RE &= [34.47 - 0.04 \cdot (0 + 30.48 + 0)] \cdot 0.66 \\ &= 21.94 \text{ N/mm}^2 \quad (\text{FELT } 21.941) \end{aligned}$$

Hence, total stress loss is given by:

$$\begin{aligned} TL &= 0 + 30.48 + 0 + 21.94 \\ &= 52.42 \text{ N/mm}^2 \quad (\text{FELT } 52.421) \end{aligned}$$

B. At second support

Over the second support the stress losses are computed as follows:

(i) Elastic shortening

$$f_{cir} = 1.0 \cdot 5.05 - 3.74 = 1.31 \text{ N/mm}^2 \text{ (C)}$$

$$\begin{aligned} ES &= 0.5 \cdot (193000/8079) \cdot 1.31 \\ &= 15.65 \text{ N/mm}^2 \quad (\text{FELT } 15.649) \end{aligned}$$

(ii) Shrinkage

Same as in the preceding case;

$$SH = 30.48 \text{ N/mm}^2$$

(iii) Creep

$$f_{\text{cir}} = 1.31 \text{ N/mm}^2 \text{ (C)}$$

$$f_{\text{cds}} = 0.40 \text{ N/mm}^2 \text{ (T)}$$

$$\begin{aligned} \text{CR} &= 1.60 * (193000/24680) * (1.31 - 0.40) / 1000 \\ &= 11.39 \text{ N/mm}^2 \quad \text{(FELT 11.386)} \end{aligned}$$

(iv) Relaxation

$$f_{\text{pi}} = 1232.32 \text{ N/mm}^2$$

$$f_{\text{pi}}/f_{\text{pu}} = 1232.32/1861 = 0.662$$

$$C = 0.61$$

$$\begin{aligned} \text{RE} &= [34.47 - 0.04 * (30.48 + 11.39 + 15.65)] * 0.61 \\ &= 19.62 \text{ N/mm}^2 \quad \text{(FELT 19.619)} \end{aligned}$$

Hence, total stress loss is

$$\begin{aligned} \text{TL} &= 30.48 + 11.39 + 15.65 + 19.62 \\ &= 77.14 \text{ N/mm}^2 \quad \text{(FELT 77.135)} \end{aligned}$$

ADAPT Corporation, Redwood City, CA, USA
 ADAPT International Pvt. Ltd., Kolkata, India
 ADAPT Latin America, Miami, FL, USA
 support@adaptsoft.com, www.adaptsoft.com

ADAPT-FELT Standard 2011
 ADAPT POST-TENSIONING STRESS LOSS & ELONGATION PROGRAM
 This program calculates the long-term and immediate stress losses in a post-tensioned tendon. It outputs the elongations at the stressing ends and the final stress profile along the tendon.

DATE: Jan 11, 2011

TIME: 11:37:16

PROJECT TITLE :
 FRIC. & LT LOSS GROUTED BEAM, MID-POINT 1ST SPAN

SPECIFIC TITLE :
 (LOSM-EX4)

LONG - TERM LOSS CALCULATIONS :

INPUT PARAMETERS :

Post-tensioning system	BONDED	
Type of strand	LOW LAX	
Ultimate strength of strand	1861.00	N/mm ²
Modulus of elasticity of strand	193000.00	N/mm ²
Initial stress in strand (at release).....	1256.50	N/mm ²
Concrete strength at 28 days	27.58	N/mm ²
Average weight of concrete	NORMAL	
Estimated age of concrete at stressing	3	days
Modulus of elasticity of concrete at stressing	8078.00	N/mm ²
Modulus of elasticity of concrete at 28 days	24680.00	N/mm ²
Estimate of average relative humidity	70.	%
Volume to surface ratio of member	103.60	mm
Initial stress in concrete due to prestressing *.....	6.37	N/mm ²
Initial stress in concrete due to selfweight *.....	-7.01	N/mm ²
Concrete stress due to superimposed sustained loading *.	-0.76	N/mm ²
* Concrete stresses refer to height at tendon centroid Compressive stresses shown positive		

CALCULATED VALUES :

Elastic shortening	0.00	N/mm ²
Shrinkage	30.48	N/mm ²
Creep	0.00	N/mm ²
Relaxation	21.94	N/mm ²

Total long-term stress losses	52.42	N/mm ²

F R I C T I O N & E L O N G A T I O N C A L C U L A T I O N S :

INPUT PARAMETERS :

Coefficient of angular friction (meu).....	0.25000	/radian
Coefficient of wobble friction (K).....	0.00060	rad/m
Ultimate strength of strand	1861.00	N/mm ²
Ratio of jacking stress to strand's ultimate strength	0.75	
Anchor set	6.00	mm
Cross-sectional area of strand	95.630	mm ²
Total Number of Strands per Tendon.....	1	
STRESSING	AT BOTH ENDS	

LEGEND :

P = Tendon profile type defined as: 1=reversed parabola;
 2=partial/regular parabola; 3=harped; 4=general; 5=straight;
 6=extended reversed parabola; 7=cantilever down
 X1/L etc = horizontal distances to control points in geometry of the
 tendon divided by span length
 Stresses tabulated are after anchor set but before long-term losses.

TENDON ID, GEOMETRY AND STRESS PROFILE (LOSM-EX4)

SPAN	m	P	< TENDON HEIGHT mm.>			Horizontal ratios			<- STRESS (N/mm ²)->		
			start	center	right	X1/L	X2/L	X3/L	start	center	right
-1----	2-----	3-----	4-----	5-----	6-----	7-----	8-----	9-----	10-----	11-----	12-
1	18.29	1	568.0	76.0	787.0	0.00	0.50	0.10	1181.71	1256.50	1232.23
2	9.14	1	787.0	152.0	568.0	0.10	0.50	0.00	1232.23	1141.28	1026.14

	27.43 m		(total length of tendon)								

SUMMARY :

Average initial stress (after release).....	1216.53	N/mm ²
Long term stress losses	52.42	N/mm ²
Final average stress	1164.11	N/mm ²
Final average force in tendon	111323.85	N
Anchor set influence from left pull (1288.73N/mm ² ;0.692)	13.52	m
Anchor set influence from right pull (1210.94N/mm ² ;0.651)	7.57	m
Elongation at left pull before anchor set	176.	mm
Elongation at right pull before anchor set	9.	mm
Elongation at left pull after anchor set	170.	mm
Elongation at right pull after anchor set	3.	mm
Total elongation after anchor set	173.	mm
Ratio of total elongation to tendon length after anchor set	6.	mm/m
Jacking force	133475.57	N

CRITICAL STRESS RATIOS :

At stressing 0.75; At anchorage 0.63; Max along tendon 0.69

ADAPT Corporation, Redwood City, CA, USA
 ADAPT International Pvt. Ltd., Kolkata, India
 ADAPT Latin America, Miami, FL, USA
 support@adaptsoft.com, www.adaptsoft.com

ADAPT-FELT Standard 2011
 ADAPT POST-TENSIONING STRESS LOSS & ELONGATION PROGRAM
 This program calculates the long-term and immediate stress losses in a post-tensioned tendon. It outputs the elongations at the stressing ends and the final stress profile along the tendon.

DATE: Jan 11, 2011

TIME: 11:43:44

P R O J E C T T I T L E :
 FRIC. & LT LOSS GROUTED BEAM, OVER 2ND SUPPORT

S P E C I F I C T I T L E :
 (LOSM-EX5)

L O N G - T E R M L O S S C A L C U L A T I O N S :

INPUT PARAMETERS :

Post-tensioning system	BONDED	
Type of strand	LOW LAX	
Ultimate strength of strand	1861.00	N/mm ²
Modulus of elasticity of strand	193000.00	N/mm ²
Initial stress in strand (at release).....	1232.30	N/mm ²
Concrete strength at 28 days	27.58	N/mm ²
Average weight of concrete	NORMAL	
Estimated age of concrete at stressing	3	days
Modulus of elasticity of concrete at stressing	8078.00	N/mm ²
Modulus of elasticity of concrete at 28 days	24680.00	N/mm ²
Estimate of average relative humidity	70.	%
Volume to surface ratio of member	103.60	mm
Initial stress in concrete due to prestressing *.....	5.05	N/mm ²
Initial stress in concrete due to selfweight *.....	-3.74	N/mm ²
Concrete stress due to superimposed sustained loading *.	-0.40	N/mm ²

* Concrete stresses refer to height at tendon centroid
 Compressive stresses shown positive

CALCULATED VALUES :

Elastic shortening	15.65	N/mm ²
Shrinkage	30.48	N/mm ²
Creep	11.39	N/mm ²
Relaxation	19.62	N/mm ²

Total long-term stress losses	77.13	N/mm ²

ADAPT POST-TENSIONING SOFTWARE SYSTEM DATE: Sep 10,1992 TIME: 16:21
 Data ID: LOSM-EX4 Output File ID: DLBMSF.DAT

BENDING MOMENT AND SHEAR FORCE DISTRIBUTION DUE TO DEAD LOADING
 SHEAR REFER TO FULL LOADING ON ALL SPANS. UNITS ARE ALL IN (kNm, kN)

SPAN = 1		LENGTH = 18.29		meter	
X/L	X	MOMENT	SHEAR		
.00	.00	-.1383E+00	-.1811E+03		
.05	.91	.1553E+03	-.1588E+03		
.10	1.83	.2903E+03	-.1365E+03		
.15	2.74	.4049E+03	-.1142E+03		
.20	3.66	.4992E+03	-.9194E+02		
.25	4.57	.5731E+03	-.6965E+02		
.30	5.49	.6266E+03	-.4736E+02		
.35	6.40	.6597E+03	-.2508E+02		
.40	7.32	.6725E+03	-.2792E+01		
.45	8.23	.6648E+03	.1949E+02		
.50	9.15	.6368E+03	.4178E+02		
.55	10.06	.5884E+03	.6407E+02		
.60	10.97	.5196E+03	.8635E+02		
.65	11.89	.4305E+03	.1086E+03		
.70	12.80	.3209E+03	.1309E+03		
.75	13.72	.1910E+03	.1532E+03		
.80	14.63	.4071E+02	.1755E+03		
.85	15.55	-.1300E+03	.1978E+03		
.90	16.46	-.3210E+03	.2201E+03		
.95	17.38	-.5325E+03	.2424E+03		
1.00	18.29	-.7643E+03	.2646E+03		

SPAN = 2		LENGTH = 9.14		meter	
X/L	X	MOMENT	SHEAR		
.00	.00	-.7643E+03	-.1950E+03		
.05	.46	-.6777E+03	-.1838E+03		
.10	.91	-.5962E+03	-.1727E+03		
.15	1.37	-.5199E+03	-.1616E+03		
.20	1.83	-.4486E+03	-.1504E+03		
.25	2.29	-.3824E+03	-.1393E+03		
.30	2.74	-.3212E+03	-.1282E+03		
.35	3.20	-.2652E+03	-.1170E+03		
.40	3.66	-.2143E+03	-.1059E+03		
.45	4.11	-.1684E+03	-.9475E+02		
.50	4.57	-.1277E+03	-.8362E+02		
.55	5.03	-.9201E+02	-.7248E+02		
.60	5.48	-.6143E+02	-.6134E+02		
.65	5.94	-.3594E+02	-.5020E+02		
.70	6.40	-.1555E+02	-.3907E+02		
.75	6.86	-.2372E+00	-.2793E+02		
.80	7.31	.9982E+01	-.1679E+02		
.85	7.77	.1511E+02	-.5656E+01		
.90	8.23	.1515E+02	.5481E+01		
.95	8.68	.1010E+02	.1662E+02		
1.00	9.14	-.3697E-01	.2776E+02		

TABLE 6.3-1

ADAPT POST-TENSIONING SOFTWARE SYSTEM DATE: Sep 10,1992 TIME: 16:21
 Data ID: LOSM-EX4 Output File ID: PTBMSF.DAT

BENDING MOMENT AND SHEAR FORCE DISTRIBUTION DUE TO POST-TENSIONING
 SHEAR REFER TO FULL LOADING ON ALL SPANS. UNITS ARE ALL IN (kNm, kN)

SPAN = 1 LENGTH = 18.29 meter			
X/L	X	MOMENT	SHEAR
.00	.00	.6930E+00	-.2065E+02
.05	.91	-.9371E+02	.9674E+02
.10	1.83	-.1762E+03	.8370E+02
.15	2.74	-.2467E+03	.7065E+02
.20	3.66	-.3053E+03	.5761E+02
.25	4.57	-.3520E+03	.4457E+02
.30	5.49	-.3868E+03	.3152E+02
.35	6.40	-.4096E+03	.1848E+02
.40	7.32	-.4205E+03	.5439E+01
.45	8.23	-.4195E+03	-.7604E+01
.50	9.15	-.4066E+03	-.2065E+02
.55	10.06	-.3769E+03	-.4419E+02
.60	10.97	-.3257E+03	-.6774E+02
.65	11.89	-.2529E+03	-.9128E+02
.70	12.80	-.1587E+03	-.1148E+03
.75	13.72	-.4286E+02	-.1384E+03
.80	14.63	.9448E+02	-.1619E+03
.85	15.55	.2534E+03	-.1855E+03
.90	16.46	.4338E+03	-.2090E+03
.95	17.38	.5819E+03	-.1148E+03
1.00	18.29	.6438E+03	-.2065E+02

SPAN = 2 LENGTH = 9.14 meter			
X/L	X	MOMENT	SHEAR
.00	.00	.6438E+03	.4132E+02
.05	.46	.5865E+03	.2097E+03
.10	.91	.4521E+03	.3780E+03
.15	1.37	.2890E+03	.3359E+03
.20	1.83	.1450E+03	.2939E+03
.25	2.29	.2032E+02	.2518E+03
.30	2.74	-.8515E+02	.2097E+03
.35	3.20	-.1714E+03	.1676E+03
.40	3.66	-.2384E+03	.1255E+03
.45	4.11	-.2862E+03	.8341E+02
.50	4.57	-.3147E+03	.4132E+02
.55	5.03	-.3286E+03	.1925E+02
.60	5.48	-.3323E+03	-.2830E+01
.65	5.94	-.3260E+03	-.2491E+02
.70	6.40	-.3096E+03	-.4698E+02
.75	6.86	-.2831E+03	-.6906E+02
.80	7.31	-.2466E+03	-.9113E+02
.85	7.77	-.1999E+03	-.1132E+03
.90	8.23	-.1432E+03	-.1353E+03
.95	8.68	-.7632E+02	-.1574E+03
1.00	9.14	.6129E+00	-.1794E+03

TABLE 6.3-2

6.4 LONG-TERM STRESS LOSS CALCULATIONS FOR A PRECAST BEAM

Consider the precast double tee section shown in **Figure 6.4-1** with a 51 mm topping. This is the same example as in PCI Design Handbook (1978, page 3-30).

Given:

Geometry and section properties are shown in **Figure 6.4-1** and **Table 6.4-1**.

Selfweight (lightweight concrete)	7166 N/m
Superimposed sustained loading (51 mm topping)	3649 N/m
Concrete strength (28 days, f'_c)	34.47 N/mm ²
Concrete strength at release (f'_{ci})	24.13 N/mm ²

$$E_c = 4733.4 \cdot (34.47)^{1/2} = 27790 \text{ N/mm}^2$$

$$E_{ci} = 4733.4 \cdot (24.13)^{1/2} = 23252 \text{ N/mm}^2$$

Assume ambient humidity $H = 70\%$

Prestressing 12-11 mm diameter 1861 N/mm² stress relieved strands depressed at midspan with following eccentricities:

$$e_c = 475.7 \text{ mm}$$

$$e_e = 325.4 \text{ mm}$$

Tendons are stressed to $0.7 \cdot f_{pu}$; hence,

$$f_{pi} = 0.7 \cdot 1861 = 1302.7 \text{ N/mm}^2$$

$$E_s = 193000 \text{ N/mm}^2$$

Required:

Determine the total long-term stress losses at the critical point.

Verification:

In a simply supported beam with a straight tendon depressed at midspan, the critical stress location is generally near the 0.4 of span. The moment at 0.4L is given by

$$M = 0.4L*(wL/2) - w*(0.4*L)^2/2 = 0.12*w*L^2$$

$$M_d = 0.12*7.166*21.34^2 = 391.6 \text{ kN-m}$$

$$M_{c ds} = 0.12*3.649*21.34^2 = 199.4 \text{ kN-m}$$

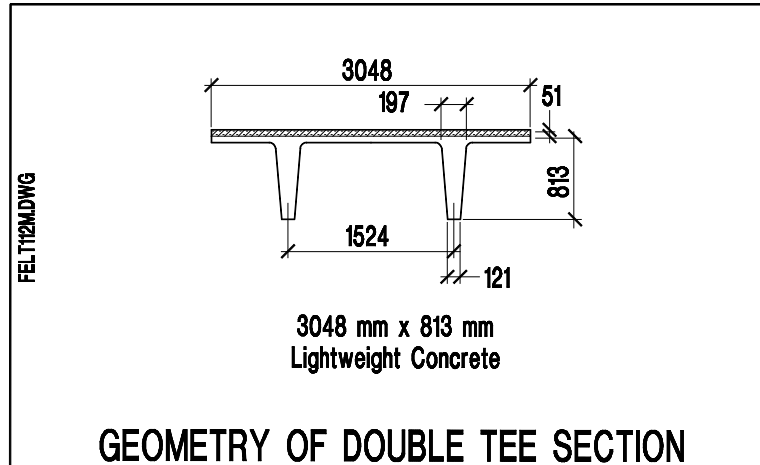

FIGURE 6.4-1

TABLE 6.4-1: SECTION PROPERTIES

f'_c	= 34.47 N/mm ²
f_{pu}	= 1861 N/mm ²
Span	= 21.34 m
A	= 396773 mm ²
I	= 2.49*10 ¹⁰ mm ⁴
Z_b	= 4.45*10 ⁷ mm ³
V/S	= 396773/9245.6 = 42.91 mm
weight	= 7.166 kN/m
weight of topping	= 3.649 kN/m

Eccentricity at 0.4L is:

$$e = 325.4 + 0.8*(475.7 - 325.4) = 445.6 \text{ mm}$$

$$P_i = 0.7*A_{ps}*f_{pu} = 0.7*12*95.63*1861 = 1495 \text{ kN}$$

Stress due to selfweight f_g :

$$\begin{aligned} f_g &= 391.6 \cdot (10^6) \cdot 445.6 / (2.49 \cdot 10^{10}) \\ &= 7.01 \text{ N/mm}^2 \text{ (T, tension)} \end{aligned}$$

Stress due to superimposed sustained loading f_{cds} :

$$\begin{aligned} f_{cds} &= 199.4 \cdot (10^6) \cdot 445.6 / (2.49 \cdot 10^{10}) \\ &= 3.57 \text{ N/mm}^2 \text{ (T, tension)} \end{aligned}$$

Stress due to prestressing f_{cpi} :

$$\begin{aligned} f_{cpi} &= P_i/A + P_i \cdot e^2/I \\ &= (1.495 \cdot 10^6) / 396773 + (1.495 \cdot 10^6) \cdot 445.6^2 / (2.49 \cdot 10^{10}) \\ &= 15.69 \text{ N/mm}^2 \text{ (C)} \end{aligned}$$

(i) Elastic shortening

$$ES = K_{es} \cdot E_s \cdot f_{cir} / E_{ci}$$

Where,

$$K_e = 1$$

$$\begin{aligned} f_{cir} &= K_{cir} \cdot f_{cpi} - f_g, \text{ with } K_{cir} = 0.9 \text{ for pretensioning} \\ &= 0.9 \cdot 15.69 - 7.01 = 7.11 \text{ N/mm}^2 \text{ (C)} \end{aligned}$$

$$ES = 1 \cdot 193000 \cdot 7.11 / 23250 = 59.02 \text{ N/mm}^2 \text{ (FELT 59.029)}$$

(ii) Creep of concrete

$$CR = K_{cr} \cdot (E_s/E_c) \cdot (f_{cir} - f_{cds})$$

Where,

$K_{cr} = 2.0$ for pretensioned members; reduce 20% due to lightweight concrete.

$$\begin{aligned} CR &= 2.0 \cdot 0.8 \cdot (193000/27790) \cdot (7.11 - 3.57) \\ &= 39.34 \text{ N/mm}^2 \text{ (C)} \quad \text{(FELT 39.347)} \end{aligned}$$

(iii) Shrinkage of concrete

$$SH = 8.2 \cdot 10^{-6} \cdot K_{sh} \cdot E_s \cdot (1 - 0.00236 \cdot V/S) \cdot (100 - RH)$$

Where,

$K_{sh} = 1$ for pretensioned members

$$\begin{aligned} SH &= 8.2 \cdot 10^{-6} \cdot 1 \cdot 193000(1 - 0.00236 \cdot 42.91) \cdot (100 - 70) \\ &= 42.67 \text{ N/mm}^2 \quad (\text{FELT } 42.663) \end{aligned}$$

(iv) Relaxation of strands

$$RE = [K_{re} - J(SH + CR + ES)] \cdot C$$

$$K_{re} = 137.90 \text{ N/mm}^2; J = 0.15 \text{ (Table 4.3-2)}$$

$$f_{pi}/f_{pu} = 0.7; \text{ hence, } C = 1.00 \text{ (Table 4.3-3)}$$

$$\begin{aligned} RE &= [137.90 - 0.15 \cdot (42.67 + 39.34 + 59.02)] \cdot 1 \\ &= 116.75 \text{ N/mm}^2 \quad (\text{FELT } 116.701) \end{aligned}$$

(v) Total long-term loss

$$\begin{aligned} LT &= ES + CR + SH + RE \\ &= 59.02 + 39.34 + 42.67 + 116.75 \\ &= 257.78 \text{ N/mm}^2 \quad (\text{FELT } 257.741) \end{aligned}$$

$$\text{Final prestress} = 0.7 \cdot 1861 - 257.78 = 1044.92 \text{ N/mm}^2$$

ADAPT Corporation, Redwood City, CA, USA
 ADAPT International Pvt. Ltd., Kolkata, India
 ADAPT Latin America, Miami, FL, USA
 support@adaptsoft.com, www.adaptsoft.com

ADAPT-FELT Standard 2011
 ADAPT POST-TENSIONING STRESS LOSS & ELONGATION PROGRAM

This program calculates the long-term and immediate stress losses in a post-tensioned tendon. It outputs the elongations at the stressing ends and the final stress profile along the tendon.

DATE: Jan 11, 2011

TIME: 11:53:51

P R O J E C T T I T L E :
 PRECAST, PRESTRESSED DOUBLE TEE BEAM LT LOSS

S P E C I F I C T I T L E :
 (LOSM-EX6)

L O N G - T E R M L O S S C A L C U L A T I O N S :

INPUT PARAMETERS :

Post-tensioning system	BONDED	
Type of strand	STRESS RELIEVED	
Ultimate strength of strand	1861.00	N/mm ²
Modulus of elasticity of strand	193000.00	N/mm ²
Initial stress in strand (at release).....	1302.70	N/mm ²
Concrete strength at 28 days	34.47	N/mm ²
Average weight of concrete	LIGHTWEIGHT	
Modulus of elasticity of concrete at stressing	23250.00	N/mm ²
Modulus of elasticity of concrete at 28 days	27790.00	N/mm ²
Estimate of average relative humidity	70.	%
Volume to surface ratio of member	42.93	mm
Initial stress in concrete due to prestressing *.....	15.69	N/mm ²
Initial stress in concrete due to selfweight *.....	-7.01	N/mm ²
Concrete stress due to superimposed sustained loading *.	-3.57	N/mm ²
* Concrete stresses refer to height at tendon centroid Compressive stresses shown positive		

CALCULATED VALUES :

Elastic shortening	59.03	N/mm ²
Shrinkage	42.66	N/mm ²
Creep	39.35	N/mm ²
Relaxation	116.70	N/mm ²

Total long-term stress losses	257.74	N/mm ²

6.5 LONG-TERM STRESS LOSS FOR A PRECAST PILE

A 356 mm square precast prestressed pile is designed for a working load of 110 tons. The pile is assumed to be supported laterally along its length with no moments at its connection to the pile cap. It is required to calculate the long-term prestressing losses.

Given:

$$\begin{aligned} \text{Pile size} &= 356 \text{ mm}^2 \\ \text{Concrete strength (28 days, } f'_c) &= 41.37 \text{ N/mm}^2 \\ \text{Concrete strength at stressing (} f'_{ci} \text{)} &= 24.13 \text{ N/mm}^2 \end{aligned}$$

$$\begin{aligned} E_c &= 4733.4 \cdot (41.37)^{1/2} = 30445 \text{ N/mm}^2 \\ E_{ci} &= 4733.4 \cdot (24.13)^{1/2} = 23252 \text{ N/mm}^2 \end{aligned}$$

Prestressing 6-11mm, 1861 N/mm² low-relaxation strands pulled to 0.7*f_{pu} at stressing.

Hence,

$$f_{pi} = 0.7 \cdot 1861 = 1303 \text{ N/mm}^2.$$

Area of each strand is 95.63 mm².

Required:

Long-term effective stress in strand.

Verification:

(i) Elastic shortening of concrete

$$SH = K_{es} \cdot E_s \cdot f_{cir} / E_{ci}$$

Where,

$$K_{es} = 1.0 \text{ for pretensioned concrete.}$$

$$f_{cir} = K_{cir} \cdot f_{cpi} - f_g$$

$$K_{cir} = 0.9 \text{ for pretensioned members}$$

Since there is no eccentricity in strand pattern, the initial concrete stress due to prestressing at the centroid of the tendon (f_{cpi}) is the same as average precompression.

$$f_{cpi} = 1303 \cdot 6 \cdot 95.63 / 356^2 = 5.90 \text{ N/mm}^2$$

Stress due to selfweight at time of transfer of prestressing to the pile, as well as when pile is in place, is zero at the top of the pile.

$$f_g = 0;$$

Hence,

$$f_{cir} = 0.90 \cdot 5.90 = 5.31 \text{ N/mm}^2$$

$$ES = 1 \cdot 193000 \cdot 5.31 / 23252 = 44.07 \text{ N/mm}^2 \quad (\text{FELT } 44.075)$$

(ii) Creep of concrete

$$CR = K_{cr} (E_s / E_c) (f_{cir} - f_{cds})$$

Where,

$$K_{cr} = 2.0 \text{ for pretensioned members}$$

In this case the dead load of the building on the pile is the sustained superimposed loading. The critical condition is the top of the pile where the superimposed loading is the highest. As f_{cds} is compressive, it will be added to the initial concrete stress f_{cir} .

$$f_{cds} = 978.6 \cdot 1000 / (356^2) = 7.72 \text{ N/mm}^2 \text{ (C)}$$

$$\begin{aligned} CR &= 2.0 \cdot (193000 / 30445) \cdot (5.31 + 7.72) \\ &= 165.20 \text{ N/mm}^2 \quad (\text{FELT } 165.202) \end{aligned}$$

(iii) Shrinkage of concrete

$$SH = 8.2 \cdot 10^{-6} \cdot K_{sh} \cdot E_s (1 - 0.00236 \cdot V/S) \cdot (100 - RH)$$

$$K_{sh} = 1.0 \text{ for pretensioned members}$$

$$V/S = (356^2) / (4 \cdot 356) = 89$$

Relative humidity at top of pile (critical location) is assumed 85%.

$$\begin{aligned} SH &= 8.2 \cdot 10^{-6} \cdot 1 \cdot 193000 \cdot (1 - 0.00236 \cdot 89) \cdot (100 - 85) \\ &= 18.75 \text{ N/mm}^2 \quad (\text{FELT } 18.748) \end{aligned}$$

(iv) Relaxation of strands

$$RE = [K_{re} - J \cdot (SH + CR + ES)] \cdot C$$

$$K_{re} = 34.47 \text{ N/mm}^2; J = 0.04 \quad (\text{Table 4.3-2})$$

$$f_{pi}/f_{pu} = 0.7; \text{ hence, } C = 0.8 \quad (\text{Table 4.3-3})$$

$$\begin{aligned} RE &= [34.47 - 0.04 \cdot (44.07 + 165.20 + 18.75)] \cdot 0.8 \\ &= 20.28 \text{ N/mm}^2 \quad (\text{FELT } 20.276) \end{aligned}$$

(v) Total long-term loss

$$\begin{aligned} LT &= ES + CR + SH + RE \\ &= 44.07 + 165.20 + 18.75 + 20.28 \\ &= 248.3 \text{ N/mm}^2 \quad (\text{FELT } 248.301) \end{aligned}$$

$$\begin{aligned} \text{Final effective prestress at pile top} &= 0.7 \cdot 1861 - 248.3 \\ &= 1054.4 \text{ N/mm}^2 \end{aligned}$$

ADAPT Corporation, Redwood City, CA, USA
 ADAPT International Pvt. Ltd., Kolkata, India
 ADAPT Latin America, Miami, FL, USA
 support@adaptsoft.com, www.adaptsoft.com

ADAPT-FELT Standard 2011
 ADAPT POST-TENSIONING STRESS LOSS & ELONGATION PROGRAM

This program calculates the long-term and immediate stress losses in a post-tensioned tendon. It outputs the elongations at the stressing ends and the final stress profile along the tendon.

DATE: Jan 11, 2011

TIME: 11:55:57

PROJECT TITLE :
 PRECAST, PRESTRESSED PILE LT LOSS, 356 mm 10 TON

SPECIFIC TITLE :
 (LOSM-EX7)

LONG - TERM LOSS CALCULATIONS :

INPUT PARAMETERS :

Post-tensioning system	BONDED	
Type of strand	LOW LAX	
Ultimate strength of strand	1861.00	N/mm ²
Modulus of elasticity of strand	193000.00	N/mm ²
Initial stress in strand (at release).....	1303.00	N/mm ²
Concrete strength at 28 days	41.37	N/mm ²
Average weight of concrete	NORMAL	
Modulus of elasticity of concrete at stressing	23252.00	N/mm ²
Modulus of elasticity of concrete at 28 days	30445.00	N/mm ²
Estimate of average relative humidity	85.	%
Volume to surface ratio of member	89.00	mm
Initial stress in concrete due to prestressing *.....	5.90	N/mm ²
Initial stress in concrete due to selfweight *.....	0.00	N/mm ²
Concrete stress due to superimposed sustained loading *.	7.72	N/mm ²

* Concrete stresses refer to height at tendon centroid
 Compressive stresses shown positive

CALCULATED VALUES :

Elastic shortening	44.07	N/mm ²
Shrinkage	18.75	N/mm ²
Creep	165.20	N/mm ²
Relaxation	20.28	N/mm ²
Total long-term stress losses	248.30	N/mm ²

APPENDIX A

A.1 EXCERPT FROM ADAPT PRINTOUT..... 123
A.2 NOTATION..... 124
A.3 REFERENCES 126

This Page Left Intentionally

BLANK

A.1 EXCERPT FROM ADAPT PRINTOUT

9.2 TENDON PARAMETERS					
	TYPE	X1/L	X2/L	X3/L	A/L
-----1-----	2-----	3-----	4-----	5-----	
1	2	.031	.500	.031	.000
2	2	.036	.500	.000	.000
3	2	.000	.500	.059	.000

<---- 9.3 SELECTED VALUES ---->					<-- 9.4 CALCULATED VALUES -->		
SPAN	FORCE (k /-)	*-<DISTANCE OF CGS in.-> Left	Center	Right	P/A (psi)	Wbal (k /-)	TOTAL FORCE (k)
--1-----	2-----	3-----	4-----	5-----	6-----	7-----	8-----
1	347.00	22.73	3.25	31.75	342.89	1.444	347.00
2	203.00	31.75	10.00	31.75	200.59	1.011	203.00
3	203.00	31.75	28.00	22.73	200.59	-.521	203.00

* ALL distances are heights from soffit of respective member at mid-span
 Approximate weight of strand 780.3 LB

**EXCERPT FROM ADAPT PRINTOUT
 TENDON PARAMETERS REQUIRED FOR ADAPT-FELT INPUT**

A.2 NOTATION

a	= Anchor set;
A	= cross sectional area;
c	= distance from centroidal axis to farthest fibers;
CR	= stress loss due to creep;
e	= eccentricity of tendon from centroidal axis;
E_c	= concrete's modulus of elasticity at 28 days;
E_{ci}	= concrete's modulus of elasticity at stressing age;
ES	= stress loss due to elastic shortening;
E_s	= strand's modulus of elasticity;
F_{cds}	= stress in concrete at center of gravity of tendons due to all superimposed permanent dead loads that are applied to the member after it has been prestressed;
f_{cir}	= net stress in concrete at center of gravity of tendons immediately after prestress has been applied to concrete;
f_{cpa}	= average compressive stress in concrete immediately after stressing, at a hypothetical location defined by the center of gravity of tendons;
f_{cpi}	= stress in concrete at center of gravity of tendons due to prestressing forces immediately after prestress has been applied;
f_g	= stress in concrete at center of gravity of tendons due to weight of structure at time prestress is applied;
f_{pi}	= stress in tendon immediately after transfer of prestressing;
f_{pu}	= ultimate strength of strand;
I	= moment of inertia;
J	= a coefficient for stress relaxation in tendon (Table 4.3-2);
K	= wobble coefficient of friction expressed per unit length of strand;
K_{cir}	= an adjustment coefficient for loss due to elastic shortening;
K_{cr}	= creep coefficient;
K_{es}	= a coefficient for elastic shortening stress loss calculation;
K_{re}	= a coefficient for stress relaxation in tendon;
K_{sh}	= a shrinkage constant (Table 4.3-1);
M	= moment;
M_b	= moment due to prestressing;

P_i	= force in prestressing after losses;
P_{pi}	= initial post-tensioning force immediately after transfer;
P_s	= stress at jacking point;
P_x	= stress at distance x from the jacking point;
RE	= stress loss due to relaxation of tendon;
RH	= relative humidity (percent);
SH	= stress loss due to shrinkage of concrete;
V/S	= volume to surface ratio;
X	= distance from the stressing point;
Y_b	= centroidal axis to bottom fiber;
Y_t	= centroidal axis to top fiber;
α	= change of angle in strand (radians) from the stressing point to distance
X;	
μ	= coefficient of angular friction;
*	= multiplication symbol.

A.3 REFERENCES

Aalami, B. and Barth, F., Restraint Cracks and Their Mitigation in Unbonded Post-Tensioned Building Structures, American Concrete Institute SP113, 1989, pp. 157-179.

AASHTO, *Standard Specifications for Highway Bridges*, The American Society of State Highway and Transportation Officials, Twelfth Edition, 1977.

ACI, Building Code Requirements for Reinforced Concrete, publication, ACI 318-89, 1989.

ACI Committee 443, *Prestressed Concrete Bridge Design*, Journal, American Concrete Institute, Vol. 73, November 1976, pp. 597-612.

Burns, Ned H., Helwig, Todd, and Tsujimoto Tetsuya, *Effective Prestress Force in Continuous Post-Tensioned Beams with Unbonded Tendons*, ACI Structural Journal, January-February 1991, pp. 84-90.

PCI Committee on Prestress Losses, *Recommendations for Estimating Prestress Losses*, Journal, Prestressed Concrete Institute, July-August 1975, pp. 44-75.

Post-Tensioning Institute, *Newsletter*, Monthly newsletter, January 1982, p. 4.

Zia, P., Preston, H.K., Scott, N.L. and Workman E.B., *Estimating Prestress Losses*, Journal, Concrete International, June 1979, pp. 32-38.