

DESIGN OF MULTI-STORY WOOD BUILDINGS IN RISAs

Allan Mitchell, PE

1

ZOOM WEBINAR SETTINGS

Audio Options:

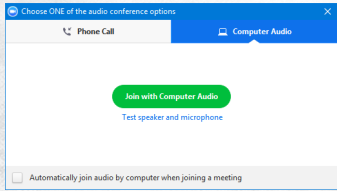
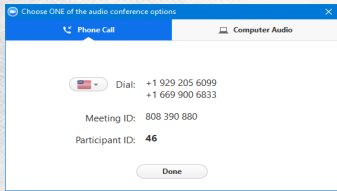

Questions:

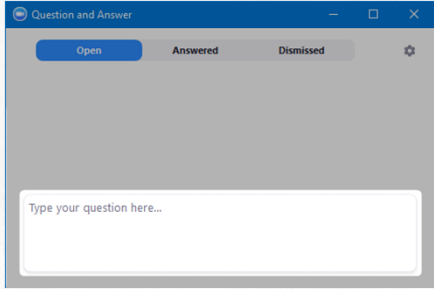
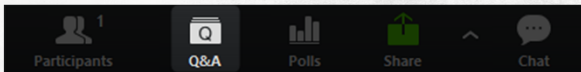

risa.com

2

LATEST VERSIONS



Version 15.0.4



Version 19.0.4



risa.com

3

REFERENCED CODES



Image Courtesy of International Code Council

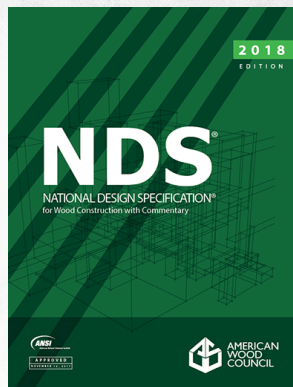

Image Courtesy of American Wood Council



risa.com

4

AGENDA

- Lateral Load Path
- Diaphragm Behavior & Options
- Wood Shear Wall Behavior
- Build a Model

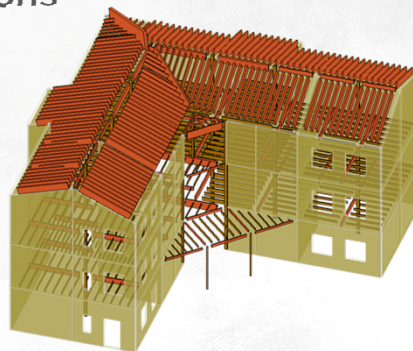

risa.com

5

LOAD PATH ILLUSTRATED

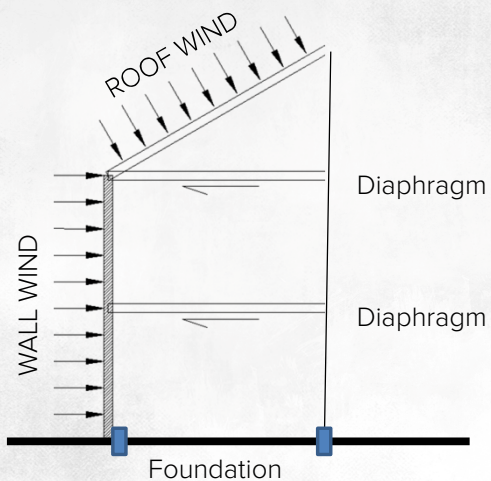

risa.com

6

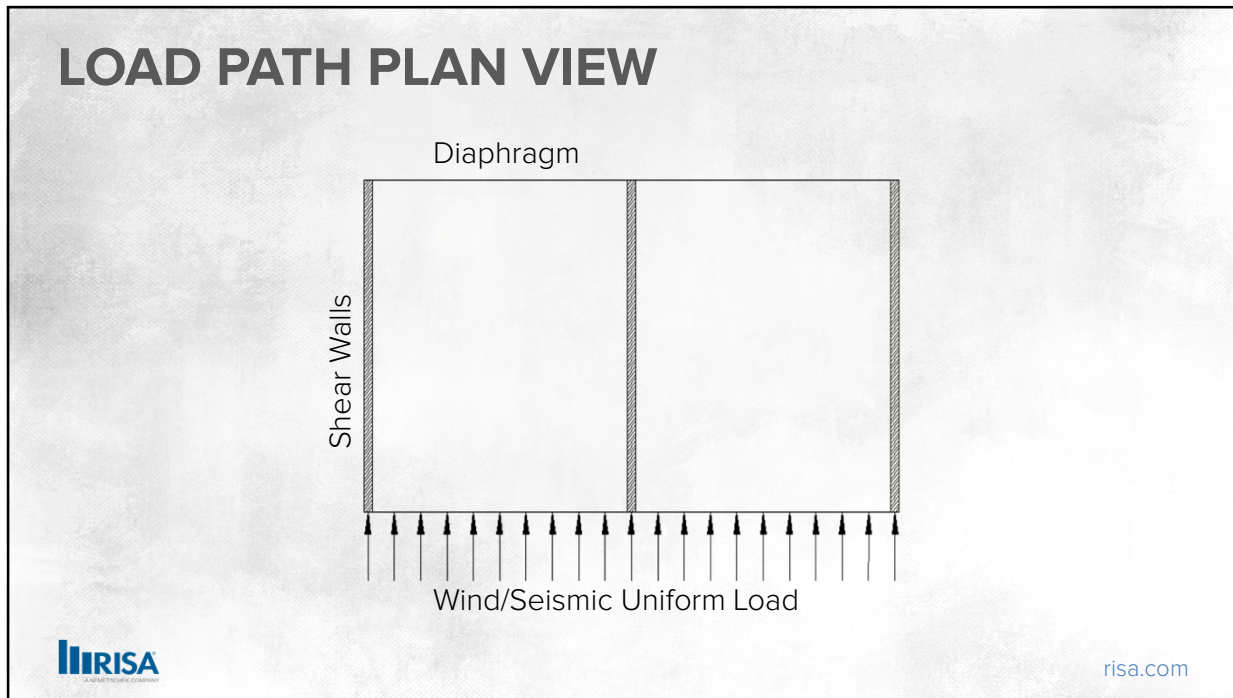

7

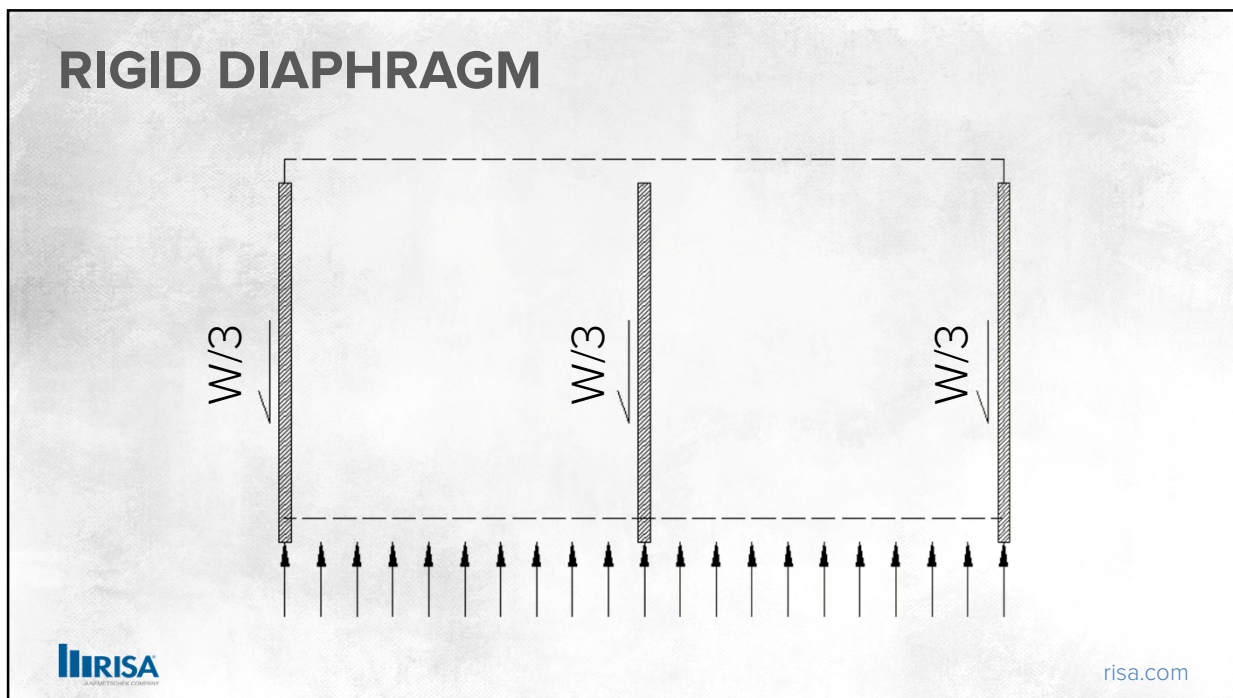

8

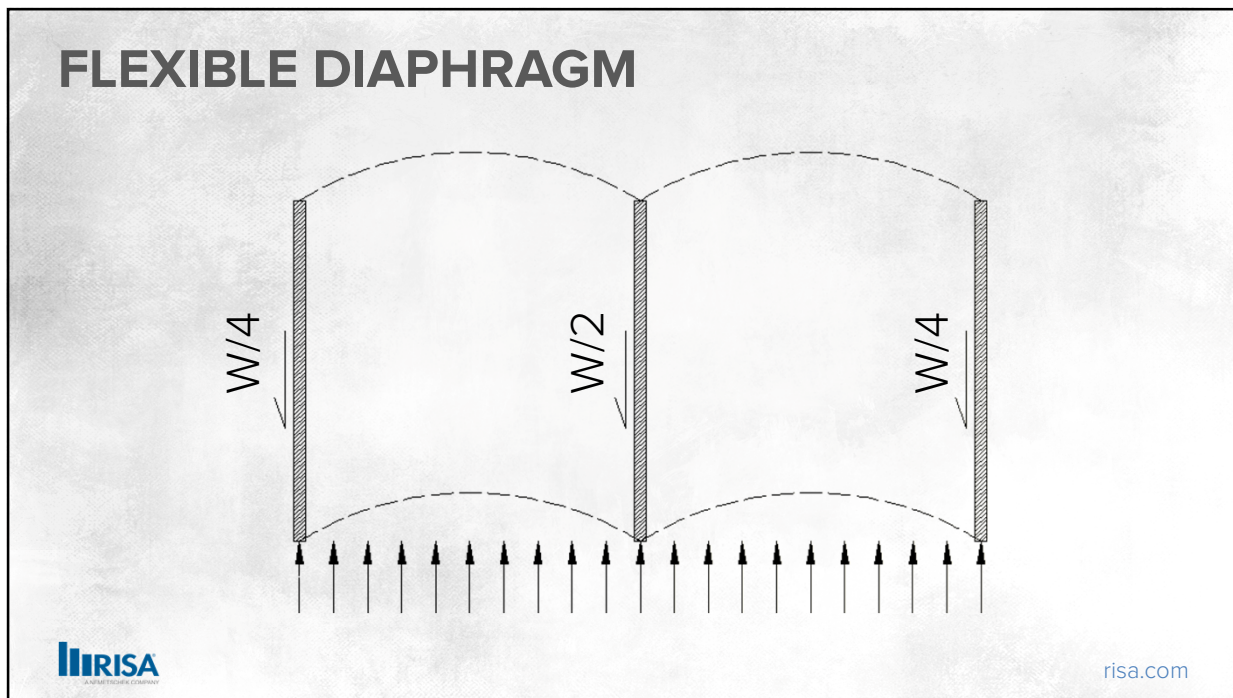

9

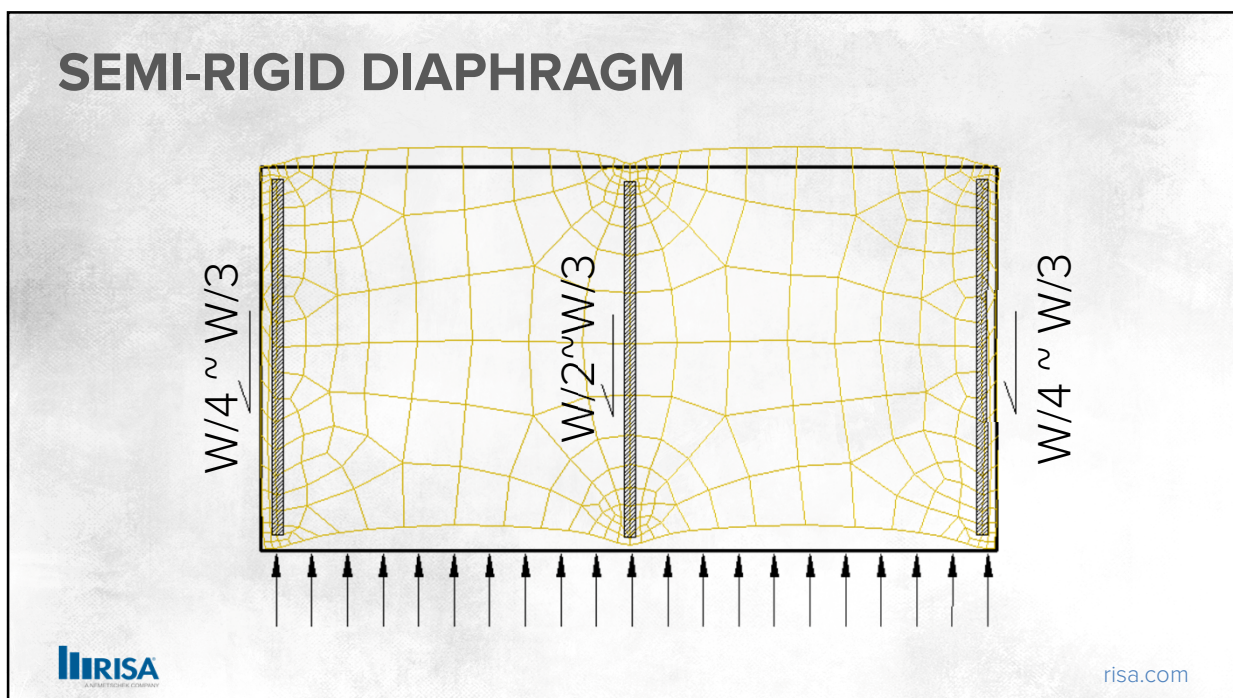

10

RIGID DIAPHRAGM – LOAD APPLICATION

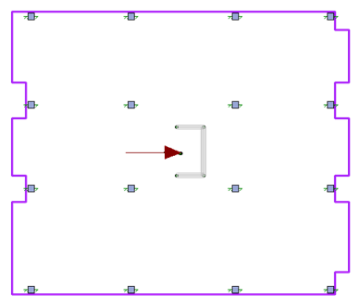

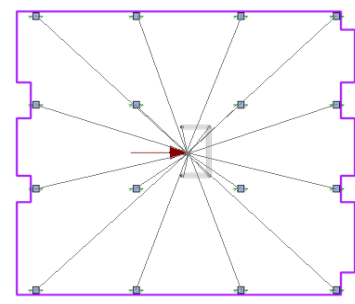

Plan View

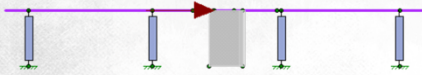

Internally- Rigid Links



Elevation View



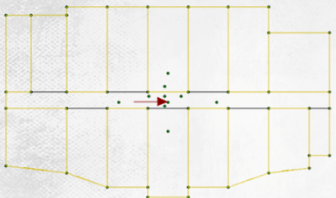

11

FLEXIBLE DIAPHRAGM – LOAD APPLICATION

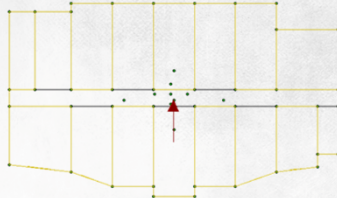

Wind Loads in Z direction (WLZ)



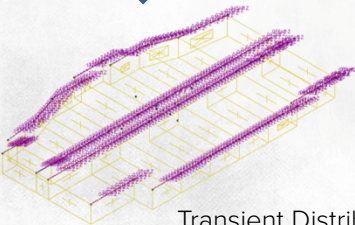

Wind Loads in X direction (WLX)

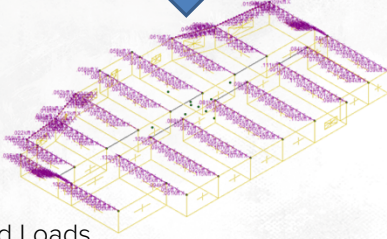



Transient Distributed Loads

12

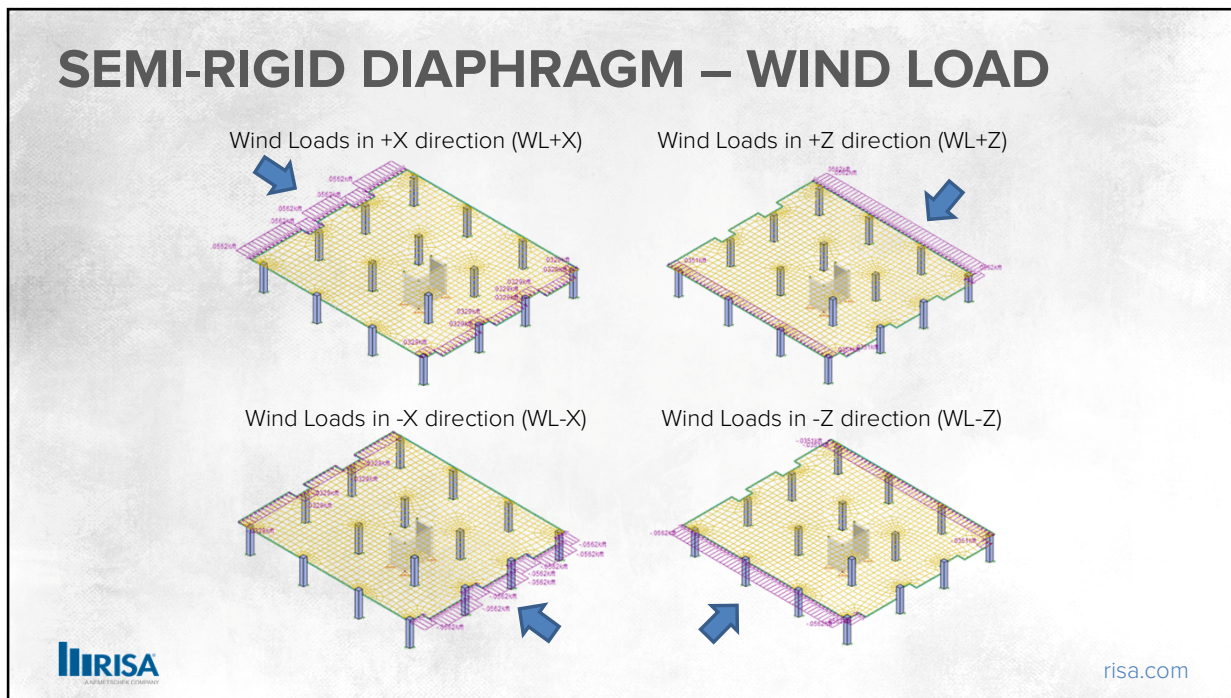

13

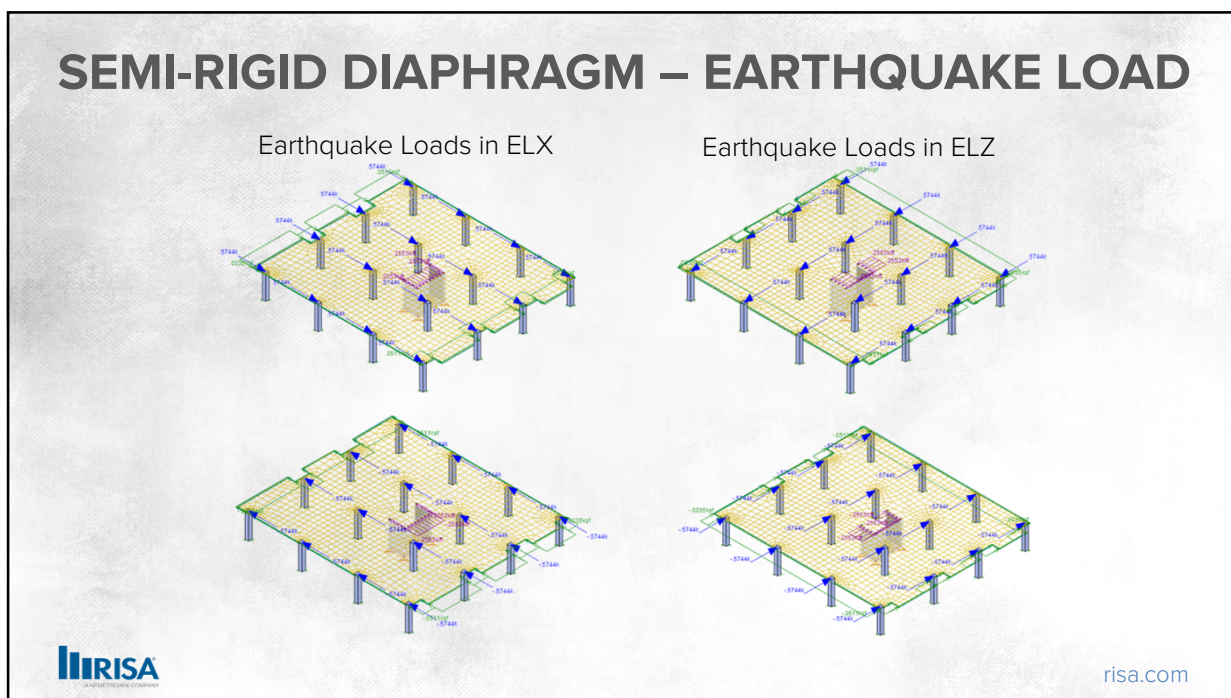

14

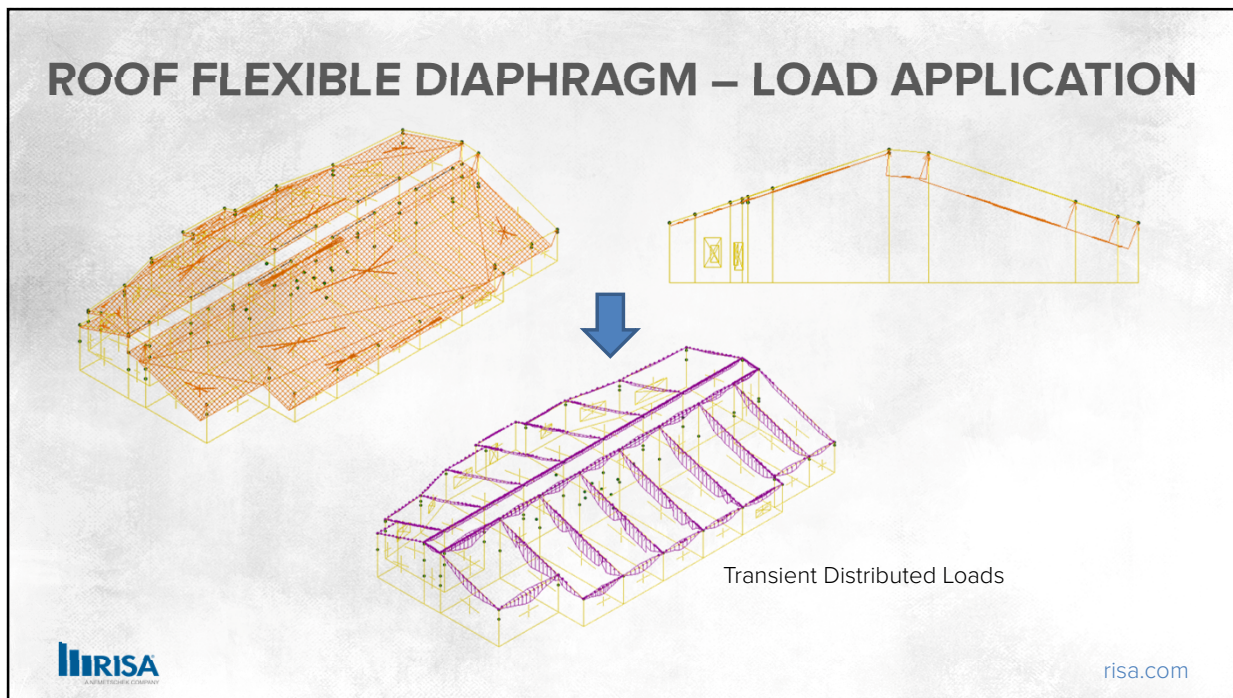

15

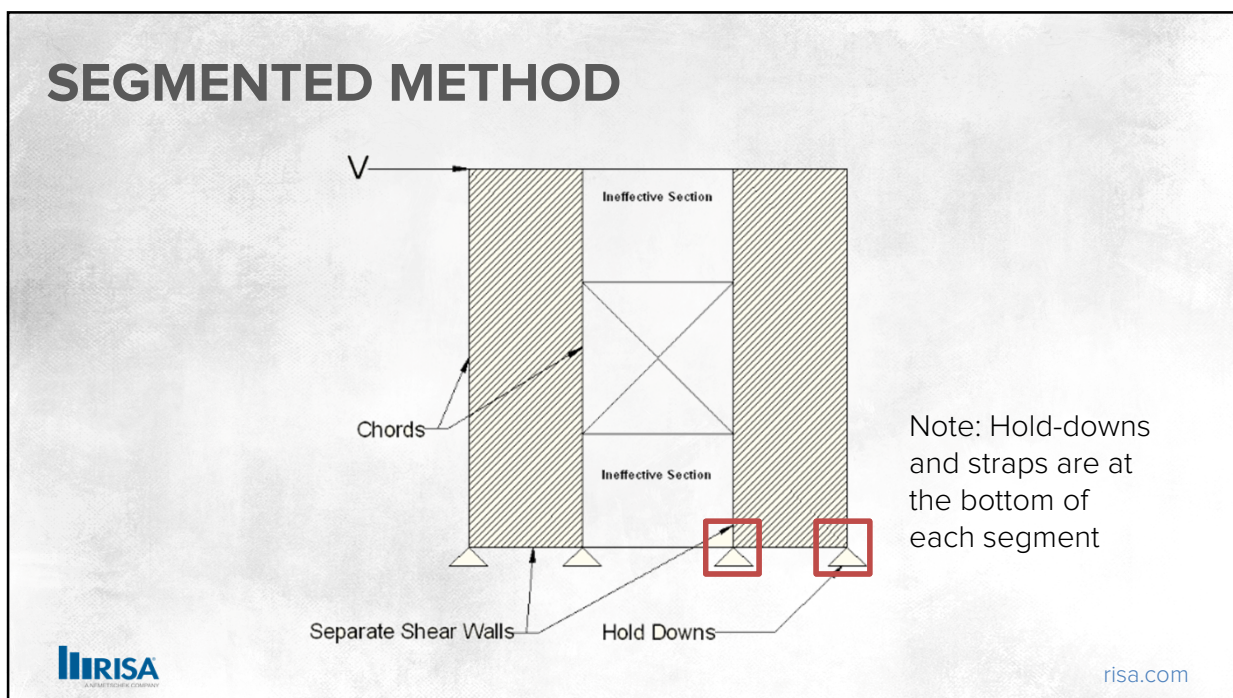

16

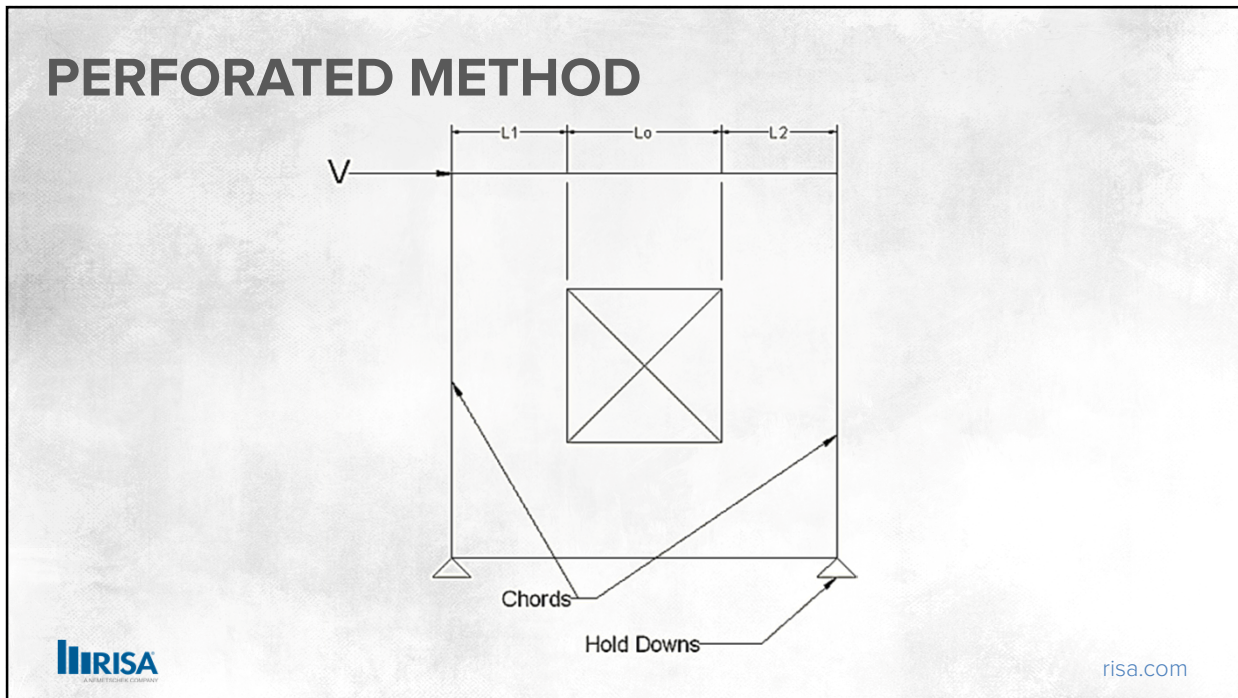

17

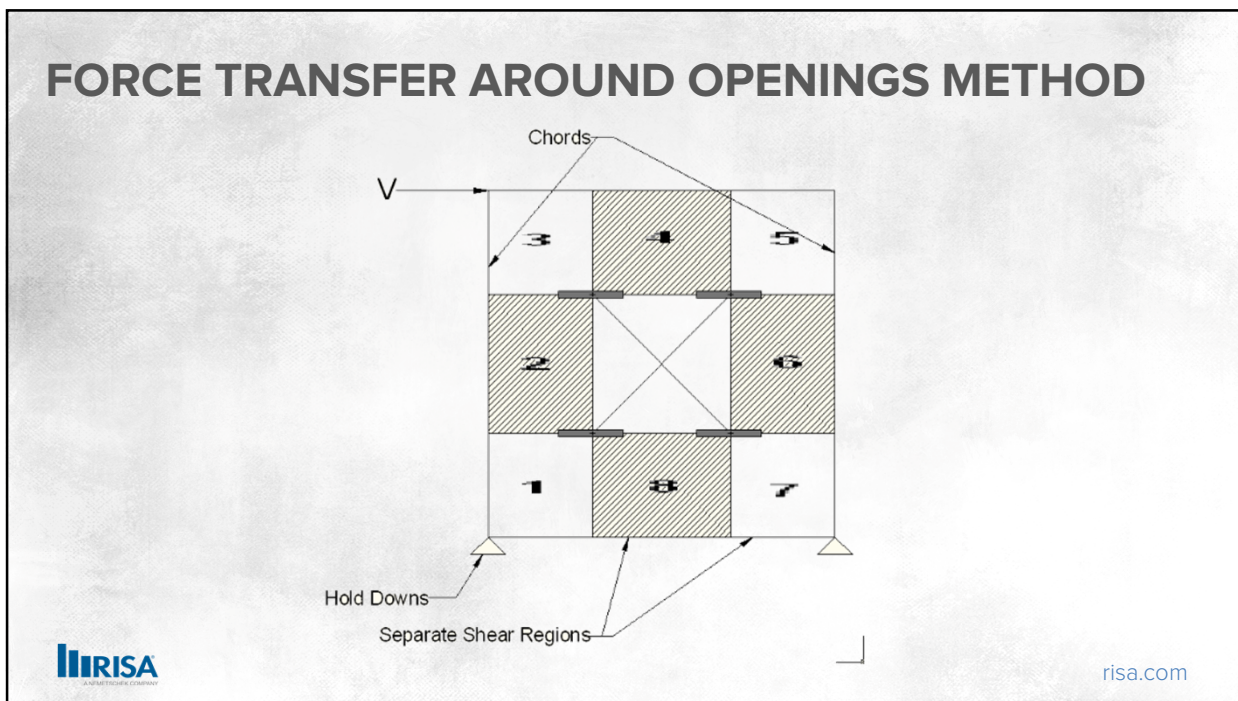

18

FINITE ELEMENT ANALYSIS

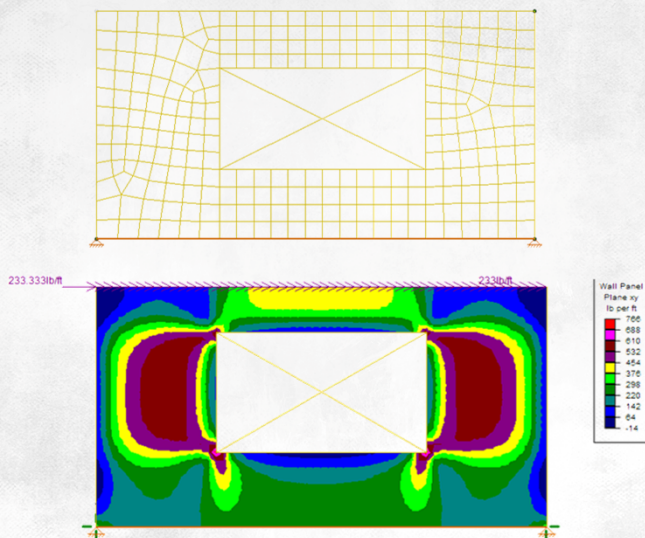

risa.com

19

LET'S BUILD A MODEL!

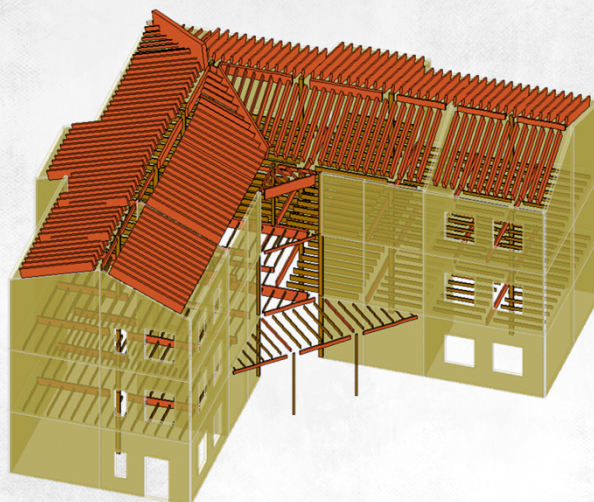

risa.com

20

ADDITIONAL RESOURCES

- Visit [risa.com/help](https://www.risa.com/help) for RISA's Online Help database
- Wood Products Council: www.woodworks.org
- For further information, contact us at info@risa.com



[risa.com](https://www.risa.com)

21



[risa.com](https://www.risa.com) | info@risa.com

22