



**ADAPT**  
Structural Concrete Software

**ADAPT-PT/RC 2019**

**Getting Started Tutorial**

ADAPT-PT mode

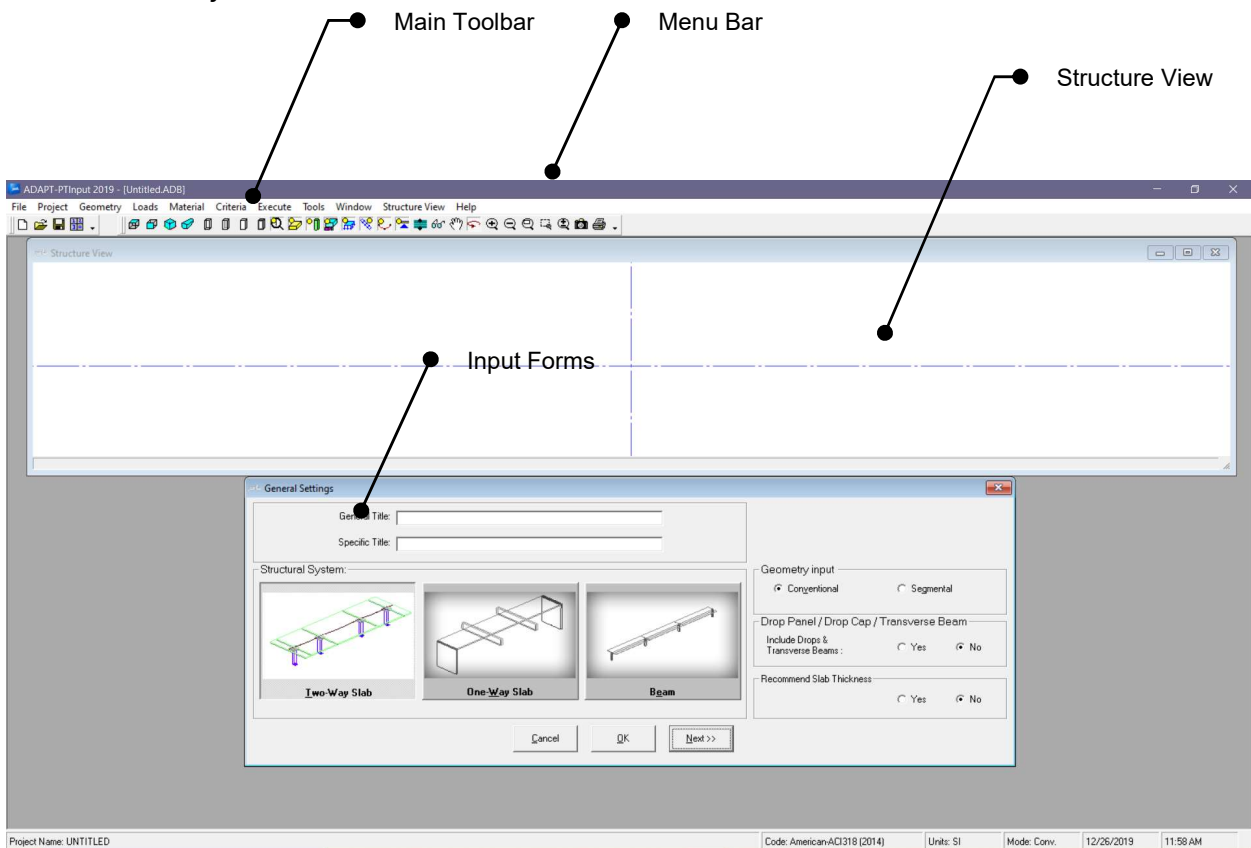
Update:

December 2019

Copyright © ADAPT Corporation all rights reserved

This ADAPT-PT/RC 2019 Getting Started Tutorial is intended to be used as a practical example and guide for modeling a 2D post-tensioned two-way slab frame in the PT mode of the program. While the example is related to a specific system type (two-way slab) the workflow applies to input of one-way slabs and beams. For additional information, refer to the **ADAPT-PT/RC 2019 Getting Started Tutorial for RC mode** and the **ADAPT-PT/RC 2019 User Manual**. Both documents can be accessed from the HELP menu of the program.

The example model is created with the help of a wizard which consists of different *Input Forms*. Each *Input Form* can be accessed at any time through the *Menu Bar*. The input that you provide on the *Input Forms* is displayed real-time in the *Structure View*. The view of the structure can be modified with the help of the *View Toolbar* which contains *View Tools* with which you can change the perspective, turn on and off components and zoom. The *Main Toolbar* contains *Common Tools* such as *New Project*, *Open Project* and *Save Project*.



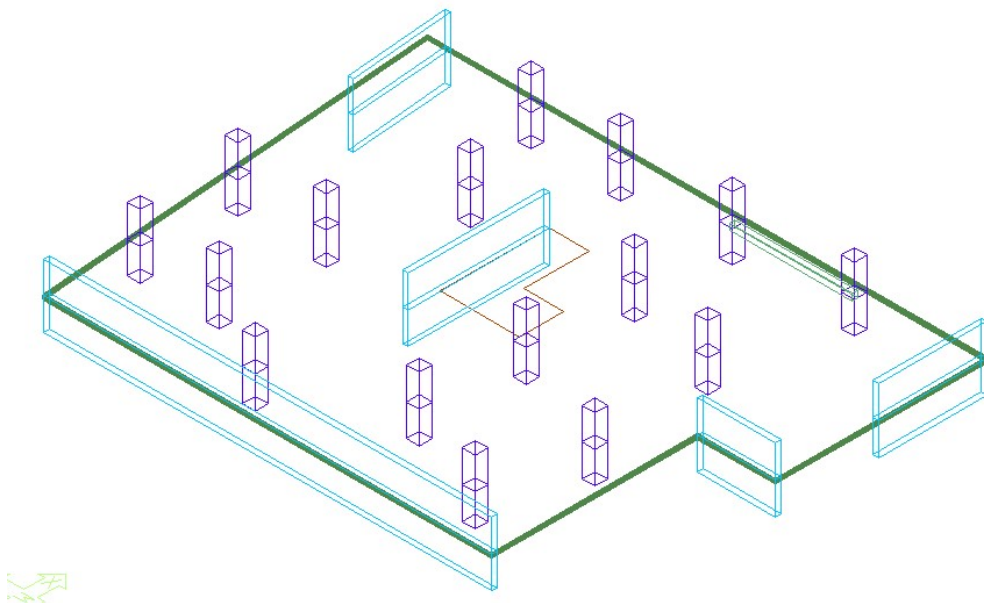
**FIGURE 1: ADAPT-PT User Interface**

## 1 COLUMN-SUPPORTED SLAB (TWO-WAY SYSTEM)

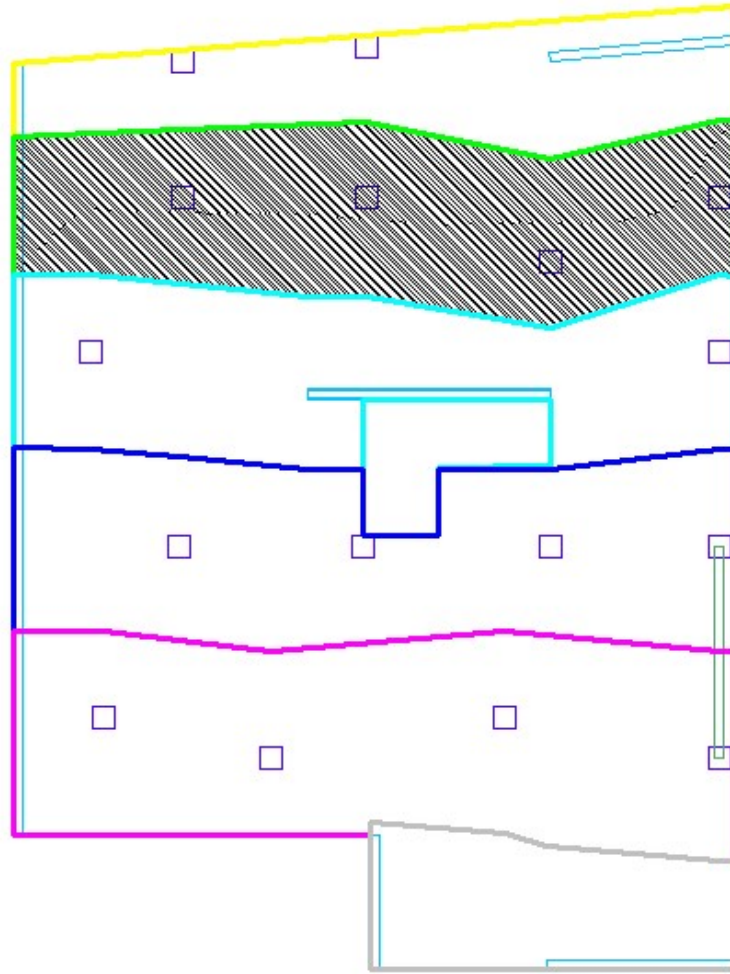
The objective of this tutorial is to explain how a floor strip or frame line is idealized from a complete floor system and modeled as a slab- or beam-frame ADAPT-PT/RC 2019. This tutorial will demonstrate the step-by-step procedure in the PT mode of ADAPT-PT/RC to generate data, analyze and design a column-supported slab which is a part of a floor system. A column-supported slab is generally considered as a two-way system. The tutorial covers the following features of the program:

- Generation of input data, using the simple “Conventional” option of the program.
- Design based on the post-tensioning “effective force” method, as opposed to selection of number of tendons.

The structure selected is a typical design strip from a floor system. The geometry, material, loading and other particulars of the structure are given below. The geometry of the whole floor is shown in **Figure 1-1**. The design strip for this tutorial is shown hatched in **Figure 1-2**.

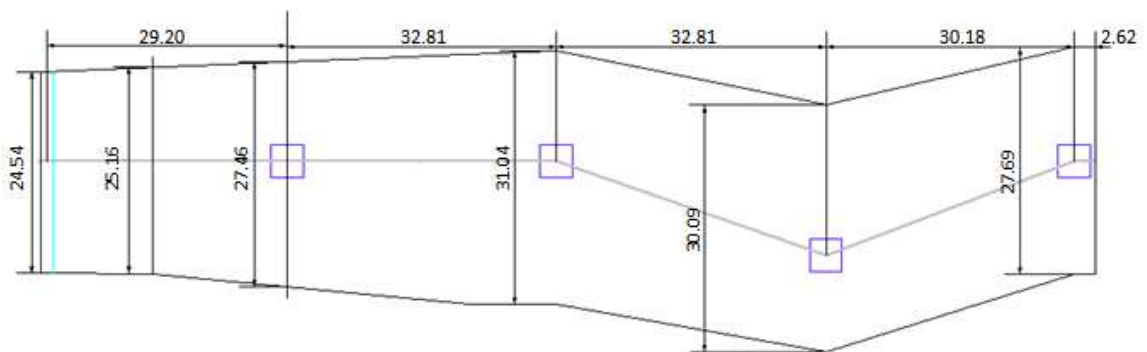


**FIGURE 1-1**



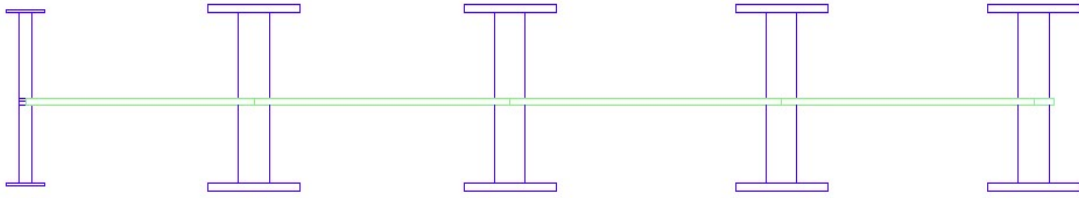
**FIGURE 1-2**

The lengths and tributary widths of the spans of the design strip in orthogonal direction are shown in **Figure 1-3**.



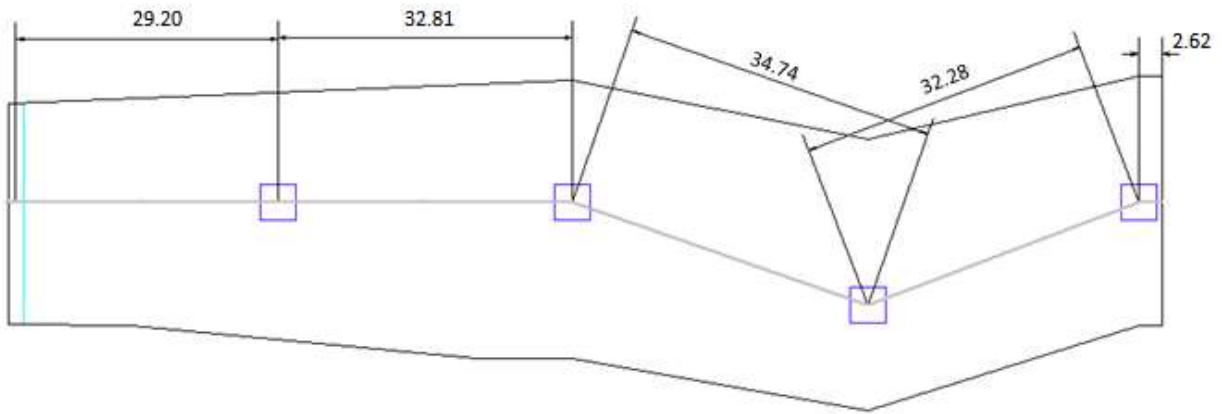
**FIGURE 1-3**

The elevation of the design strip is shown in **Figure 1-4**.



**FIGURE 1-4**

The length of the spans of the design strip along support line 2 is shown in **Figure 1-5**.



**FIGURE 1-5**

The idealized design strip is shown in **Figure 1-6**.

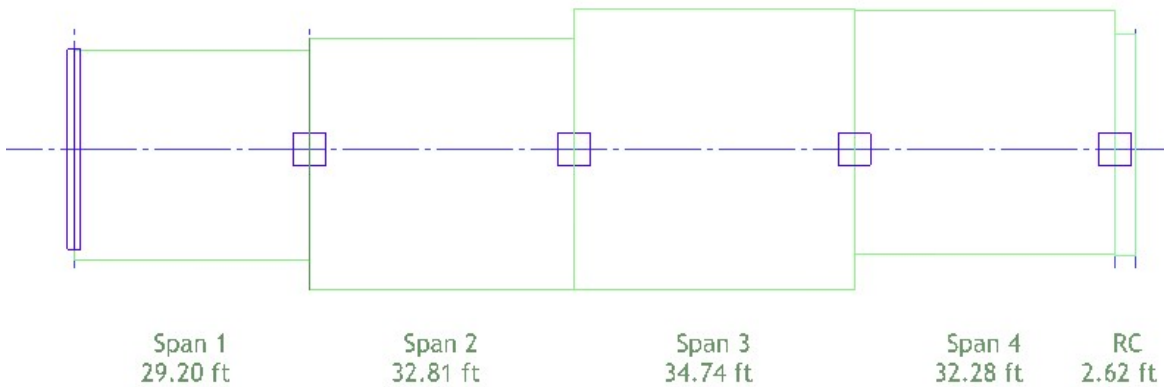


FIGURE 1-6

**MATERIAL PROPERTIES AND LOADING**

Thickness of slab = 10 inch

**(i) Material Properties**

○ Concrete:

Compressive strength,  $f'_c$  = 4000 psi  
Weight = 150 pcf  
Modulus of Elasticity = 3605 psi

○ Prestressing:

Low Relaxation, Unbonded System

Strand Diameter = 0.5 inch  
Strand Area = 0.153 inch<sup>2</sup>  
Modulus of Elasticity = 29000 ksi  
Ultimate strength of strand,  $f_{pu}$  = 270 ksi  
Minimum strand cover  
    From top fiber = 1.5 inch  
    From bottom fiber  
        Interior spans = 1.5 inch  
        Exterior spans = 2 inch

○ Nonprestressed Reinforcement:

Yield stress,  $f_y$  = 60 ksi  
Modulus of Elasticity = 29000 ksi  
Minimum Rebar Cover = 1 inch Top and Bottom

**(ii) Loading**

Superimposed Dead load = 30 psf (uniform)  
Live load = 50 psf (uniform)

## 1.1 GENERATE THE STRUCTURAL MODEL

When the program is launched from the desktop shortcut or from the computer START menu, the opening screen will appear as below. This screen gives you the option to select a design mode of **Post-Tensioned** or **Mild Reinforced**. For this tutorial, select the **Post-Tensioned** option and **OK**. This will open the PT mode of the program where the PT input forms are active and loaded.



In the ADAPT-PT 2019 input screen, click the *Options* menu and set the *Default Code* as **American-ACI318 (2014) / IBC 2015** and *Default Units* as **American**.

### 1.1.1 Edit the Project Information

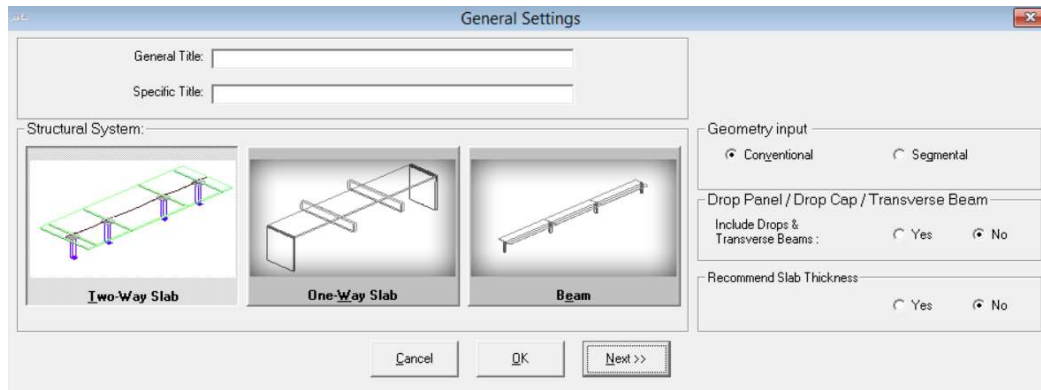
#### 1.1.1.1 General Settings

Open the new project by clicking either **New** on the *File* menu or the **New Project** button on the toolbar. This automatically opens the *General Settings* input screen, as in **Figure 1.1-1**. You can enter the *General Title* and /or *Specific Title* of the project in that window. For the purpose of this tutorial, enter the *General Title* as **Support Line 2**. This will appear at the top of the first page of the output. Enter *Specific Title* as **Two Way Slab**. This will appear at the top of each subsequent page of the output.

Next, select *Geometry Input* as **Conventional**.

Next, select the *Structural System* as **Two-Way slab**. Then there is an option to include drop caps, transverse beam and/or drop panels. In this case select **No**. Select **No** for the option to *Recommend Slab Thickness*.

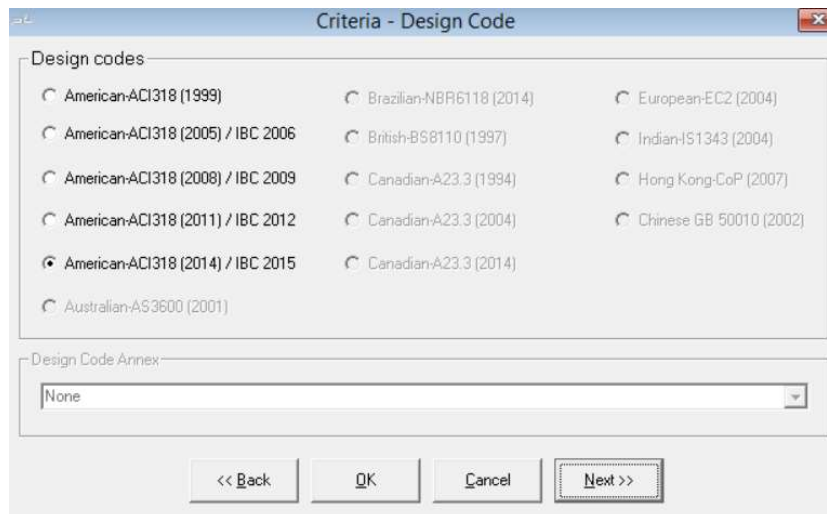
Click **Next** at the bottom right of this screen to open the next input screen, *Design Settings*.



**FIGURE 1.1-1**

### 1.1.1.2 Design Code

In the Design Code screen, set the code as **American-ACI318 (2014) / IBC 2015**.



**FIGURE 1.1-2**



### 1.1.1.3 Design Settings

This screen is divided into three parts: *Analysis options*, *Design options*, and *Contribution to unbalanced moment*.

In *Analysis options*, you can select various calculation settings. First, select the *Execution Mode* as **Interactive**.

Next, select **Yes** for *Reduce Moments to Face-of-Support* option.

Select **No** for the option to *Redistribute moments*.

Select **Yes** for the *Equivalent Frame Modeling*.

In *Design options*, **check** *Use all provisions of the code* that you have selected in the previous step.

In *Generate moment capacity based on*, **check** *Design Values*.

In *Calculation of Precompression (P/A)*, leave **unchecked**.

In *Contribution to unbalanced moment*, leave the contribution of *Top isolated bars*, and *Bottom isolated bars*, and *Post-tensioning* as default values (**100 percent**).

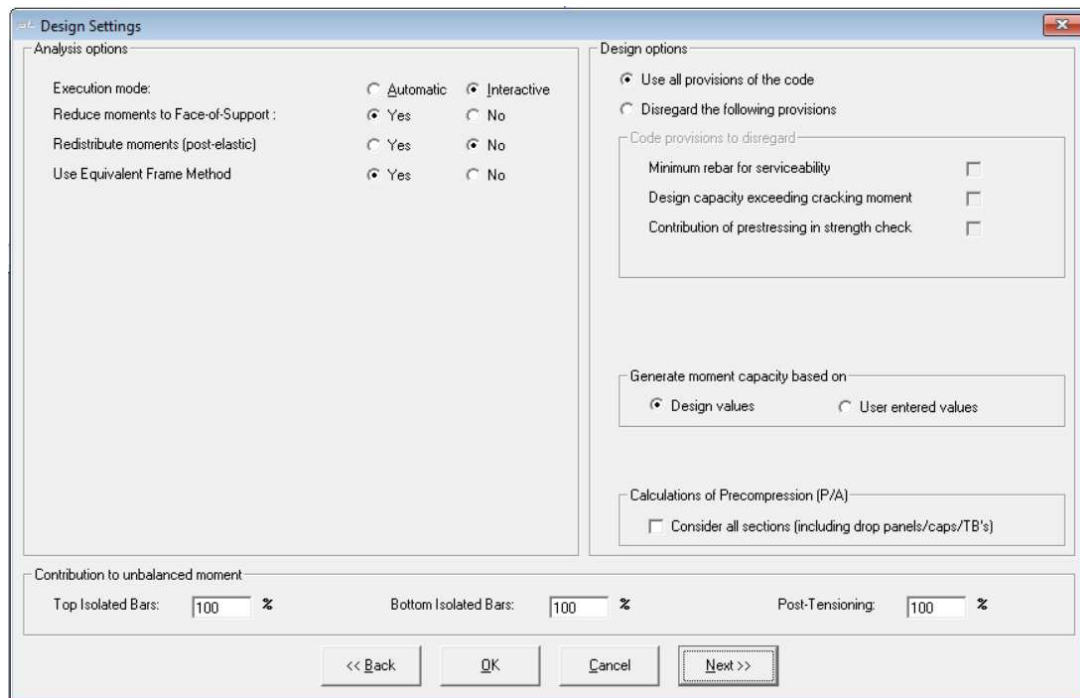
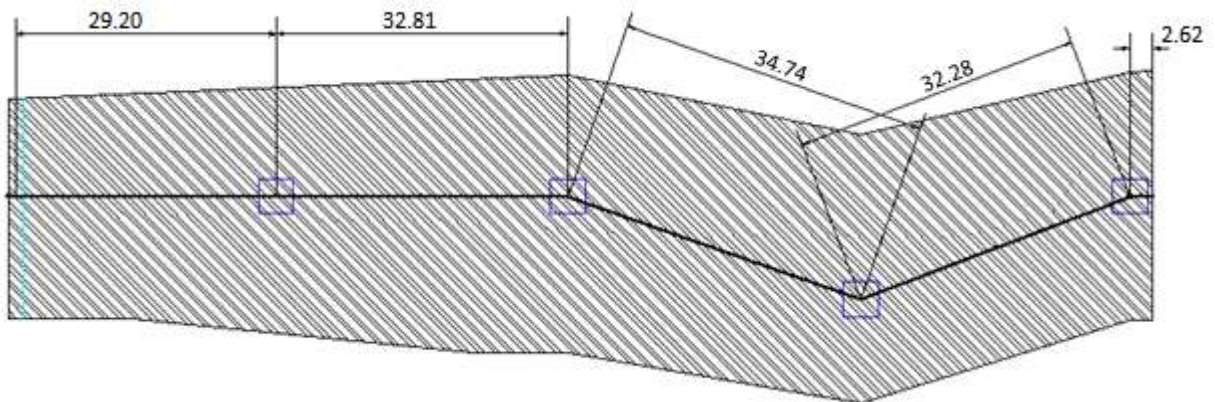


FIGURE 1.1-3

Click **Next** at the bottom right of the *Design Settings* screen to open the *Span Geometry* input screen.

## 1.1.2 Edit the Geometry of the Structure

### 1.1.2.1 Enter Span Geometry (Figure 1.1-4)



**FIGURE 1.1-4**

This screen is used to enter the cross-sectional geometry of the slab as per Figure 1-6.

Set the *Number of Spans* as **4** either by clicking the **up arrow** or using **CTRL +**.

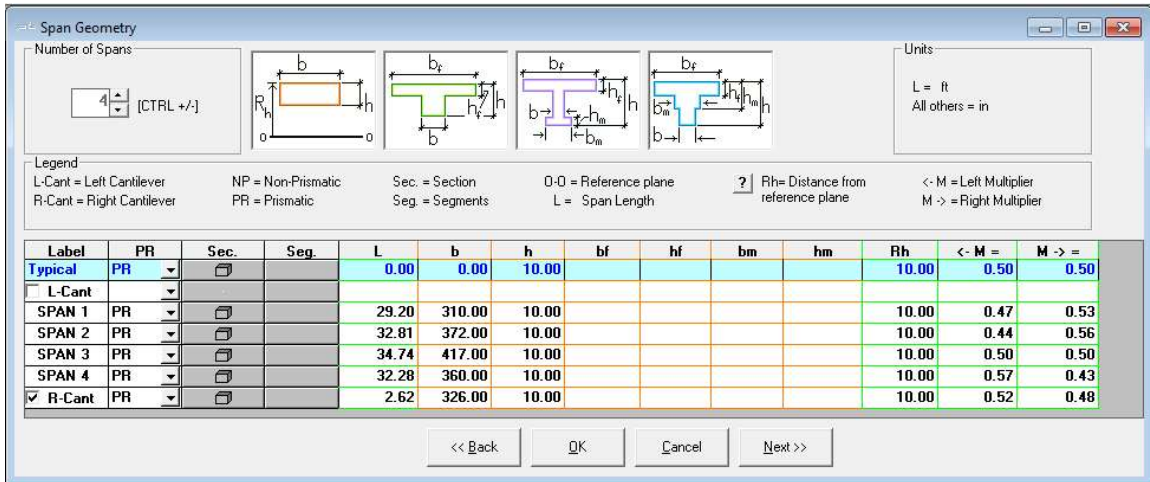
Select the section, *Sec*, as **Rectangular** and edit **29.20 ft** for length, *L*, **310.00 in** for width, *b*, and **10 in** for height, *h*, for SPAN 1. Similarly enter details for SPAN 2, 3, 4 and R-Cant as shown in Figure 1.1-5. The widths (*b*) of each span are average tributary width for that span.

As you enter the values, the span is displayed in real-time in the 3D window.

The reference height (*Rh*) identifies the position of a reference line that is used to specify the location of the tendon. Typically, the reference height is set equal to the slab depth. Edit reference height, *Rh* as **10 in**, i.e., slab depth, for all spans.

The left and right multiplier columns (<-*M* and *M*->) are used to specify the tributary width to indicate how much of the tributary falls on either side of the support line. For this tutorial, tributary method is used, i.e., tributary widths are entered as width, *b*, and

the ratio of the tributary width on either side of the support line is entered as the left and right multipliers. For SPAN 1, enter <-M and M-> as **0.47** and **0.53** respectively. Similarly enter details for SPAN 2, 3, 4 and R-Cant as shown in Figure 1.1-5.



**FIGURE 1.1-5**

Click **Next** on the bottom line to open the next input screen.

### 1.1.2.2 Enter Support Geometry

This screen is used to input column/wall heights, widths and depths. You may enter dimensions for columns/walls above and/or below the slab.

Select the **Both Columns** from the support selection. Enter **9.02 ft** for *H1* and **9.84 ft** for *H2* in the typical row and press **ENTER**, since all the supports are the same height.

Next, enter the dimensions of the supports. *B* is the dimension of the column/wall cross-section normal to the direction of the frame. *D* is the column/wall dimension parallel to the frame.

Enter the given column/wall dimensions as in **Figure 1.1-6**.

On this input screen, you can select for each support whether the left edge and the right edge of that support is interior or exterior.

In this case, all supports are interior as the span is an interior span.

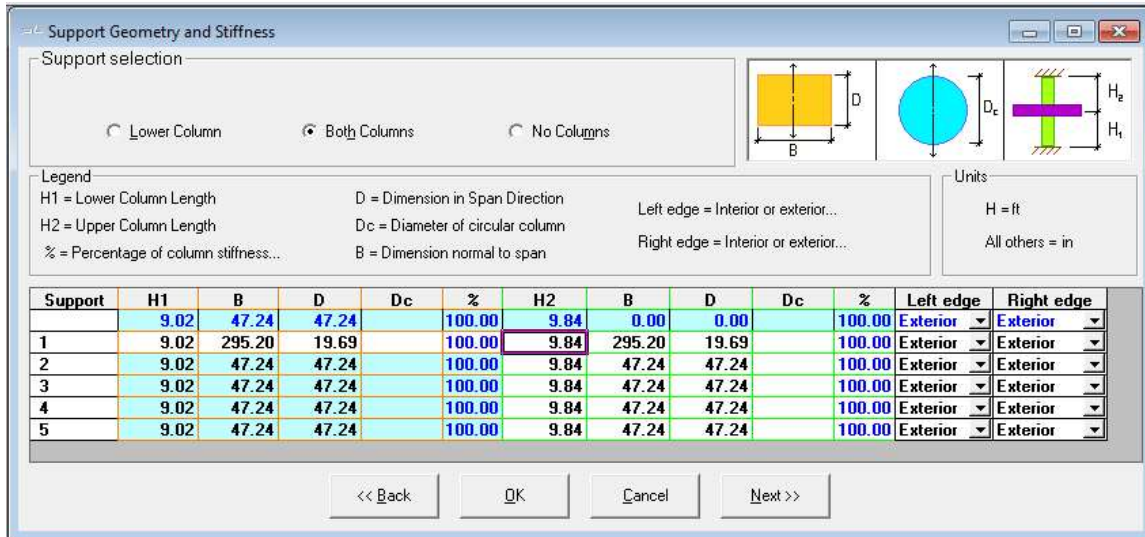


FIGURE 1.1-6

Click **Next** on the bottom line to open the *Supports Boundary Conditions* input screen.

### 1.1.2.3 Enter Support Boundary Conditions

This screen is used to enter support widths and column boundary conditions.

Support widths can be entered if you answered “Yes” to the “Reduce Moments to face-of- support” question on the *Design Settings* screen, i.e., if you answered “No”, you cannot input values in the *SW* column. This input value will be used to calculate the reduced moments.

Since the support width, *SW*, is set to the column/wall dimension (*D*) as a default, the *SW* values will be automatically determined from the support geometry and cannot be modified by the user. If you want to input the *SW* values, **uncheck** the *SW=Column Dimension box*.

Select the boundary conditions for *lower* and *upper* columns as **1(fixed)** from the drop down list.

Leave the *End Support Fixity* for both the left and right supports as default **No**. This will be used when the slab or beam is attached to a stiff member.

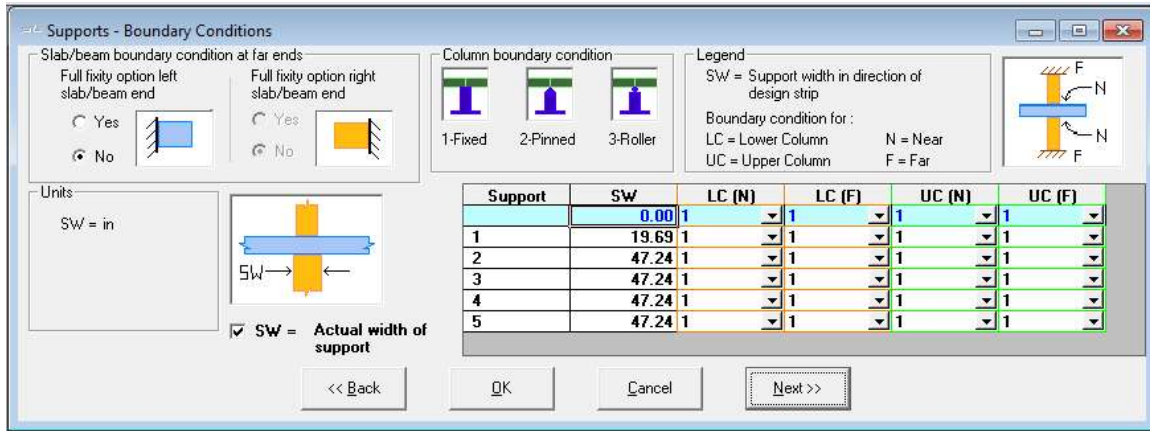


FIGURE 1.1-7

Click **Next** at the bottom of the screen to open the input screen *Loading*.

### 1.1.3 Enter Data

#### 1.1.3.1 Edit the Loading Information

Enter the span number as **1** in the *Span* column. If the loads are the same for all the spans, you can type **ALL** or **all** in the *Span* column. This will copy the data to all of the spans.

If you choose not to include Self-weight, you now have the option to define the self-weight (**SW**) as a *Class*. In any case, you can choose to specify additional dead load as superimposed dead load (**SDL**) as a *Class*.

PT/RC 2104 gives you the option to specify any load as an **X Class**.

Select the *Class* as **SDL** from the drop-down list and specify the load type as uniform either by typing **U** in *L-?* or by **dragging the icon** from the graphics of the uniform loading.

The default of the load type when you select the load class is L-U; so leave it as is for this tutorial.

Type **0.03 k/ft<sup>2</sup>** (=30 psf) for superimposed dead load in the *w* column. You can enter DL with or without self-weight, since the program can calculate self-weight automatically. In order to calculate the self-weight automatically, you must answer **Yes** to *Include Self-*

Weight question at the top right of the screen and enter **150 pcf** as unit weight of concrete.

Repeat the procedure for live load by entering the **span number** and changing the *Class* to **LL** and *w* value to **0.05 k/ft<sup>2</sup>** (=50 psf) for all spans.

Answer **Yes** to *Skip Live Load?* at the top left of the screen and enter the *Skip Factor* as **1** (**Figure 1.1-8**).

The screenshot shows the 'Loads' window with the following configuration:

- Units:** a = ft, b = ft, c = ft; w = k/ft<sup>2</sup>, P1 = k/ft, P2 = k/ft; M = k-ft, F = k
- Legend:** SW = Selfweight, LL = Live Load, X = Other user defined load case; CL = Cantilever Left, CR = Cantilever Right, SDL = Superimposed Dead Load; L/T-? = Load Type
- Skip Live Load:**  Yes  No
- Skip Factor:** 1
- Include Selfweight:**  Yes  No
- Unit Weight:** 150 pcf

Span	Class	L/T-?	w	P1	P2	a	b	c	M	F
1	all	SDL	L-U	0.030						
2	all	LL	L-U	0.050						
3										
4										

**FIGURE 1.1-8**

If you go to any other form and navigate back to the Loads input form, you will see that the loading information is now entered in the table for each span (**Figure 1.1-9**).

The screenshot shows the 'Loads' window with the following configuration:

- Units:** a = ft, b = ft, c = ft; w = k/ft<sup>2</sup>, P1 = k/ft, P2 = k/ft; M = k-ft, F = k
- Legend:** SW = Selfweight, LL = Live Load, X = Other user defined load case; CL = Cantilever Left, CR = Cantilever Right, SDL = Superimposed Dead Load; L/T-? = Load Type
- Skip Live Load:**  Yes  No
- Skip Factor:** 1
- Include Selfweight:**  Yes  No
- Unit Weight:** 150 pcf

Span	Class	L/T-?	w	P1	P2	a	b	c	M	F
1	1	SDL	L-U	0.030						
2	1	LL	L-U	0.050						
3	2	SDL	L-U	0.030						
4	2	LL	L-U	0.050						
5	3	SDL	L-U	0.030						
6	3	LL	L-U	0.050						
7	4	SDL	L-U	0.030						
8	4	LL	L-U	0.050						
9	CR	SDL	L-U	0.030						
10	CR	LL	L-U	0.050						
11										
12										
13										
14										

**FIGURE 1.1-9**

Click **Next** at the bottom of the screen to open the *Material - Concrete* input screen.

### 1.1.4 Edit the Material Properties

#### 1.1.4.1 Enter the Properties of Concrete

Select **Cylinder** concrete strength at 28 days. Select the **Normal weight** and enter the *strength at 28 days* for slab/beam and column as **4000 psi**. When you press **Enter** from the strength input value, the *Modulus of Elasticity* will be calculated automatically based on the concrete strength and the appropriate code formula.

For this tutorial, keep the value of creep coefficient as **2**. The creep coefficient will be used in the calculation of long-term deflection. Consider *Concrete strength at stressing* as **3000 psi**.

The screenshot shows a software dialog box titled "Material - Concrete". At the top, it says "Concrete strength at 28 days" with two radio buttons: "Cylinder" (which is selected) and "Cube". Below this, there are two main sections: "Slab / Beam" and "Column".

In the "Slab / Beam" section, there are three radio buttons for "Weight": "Normal" (selected), "Semi Lightweight", and "Lightweight". Below these are four input fields with their values and units: "Strength at 28 days (f'c)" is 4000 psi, "Modulus of Elasticity at 28 Days" is 3605 ksi, "Ultimate Creep Coefficient" is 2, and "Concrete strength at stressing (initial condition)(f'ci)" is 3000 psi.

In the "Column" section, there are two input fields: "Strength at 28 days (f'c)" is 4000 psi and "Modulus of Elasticity at 28 Days" is 3605 ksi.

At the bottom of the dialog box, there are four buttons: "<< Back", "Cancel", "OK", and "Next >>". The "Next >>" button is highlighted with a dashed border.

**FIGURE 1.1-10**

#### 1.1.4.2 Enter the Properties of Reinforcement

In the section *Longitudinal reinforcement*, change the values for *Yield Strength* and *Modulus of Elasticity* to **60 ksi** and **29000 ksi** respectively. Change the *Preferred Bar Sizes*

for *Top and Bottom* to **5** and **8** respectively. These will be used when calculating the number of bars required.

In Shear reinforcement, select *Stud (headed bar)* and change *Preferred Stud diameter*, *Yield strength shear reinforcement* and the *Number of rails per side* to **0.5 inch**, **60 ksi** and **2** respectively. Set the number of rails per side to **2**. Do not select the two options at the bottom-right of the input window. These are new options for v2019 and allow the user to check two-way shear with respect to seismic drift requirements as well as consideration of the least critical section,  $b_o$ , at  $d/2$  from the edge of reinforcement. Refer to the **ADAPT-PT/RC 2019 User Manual** for more information.

The screenshot shows a software dialog box titled "Material - Reinforcement". It is divided into two main sections: "Longitudinal reinforcement" and "Shear reinforcement".

**Longitudinal reinforcement:**

- Yield strength (fy) main bars: 66.72 ksi
- Modulus of elasticity: 29007.37 ksi
- Preferred bar size for top bars: 5
- Preferred bar size for bottom bars: 5
- Column Strip Allocation:
  - In spans: 60. %
  - Over interior columns: 75. %
  - Over exterior columns: 100. %

**Shear reinforcement:**

- Selected: Stud (headed bar) (radio button)
- Preferred stud diameter: 0.5 in
- Yield strength (fy) shear reinforcement: 60 ksi
- Number of rails per side "b": 2
- Number of rails per side "d": 2
- Include minimum shear reinforcement for drift:
- Consider octagonal critical sections past shear reinforced zone:
- Edge Distance of Rails: 1 in

At the bottom of the dialog box, there are four buttons: "<< Back", "OK", "Cancel", and "Next >>".

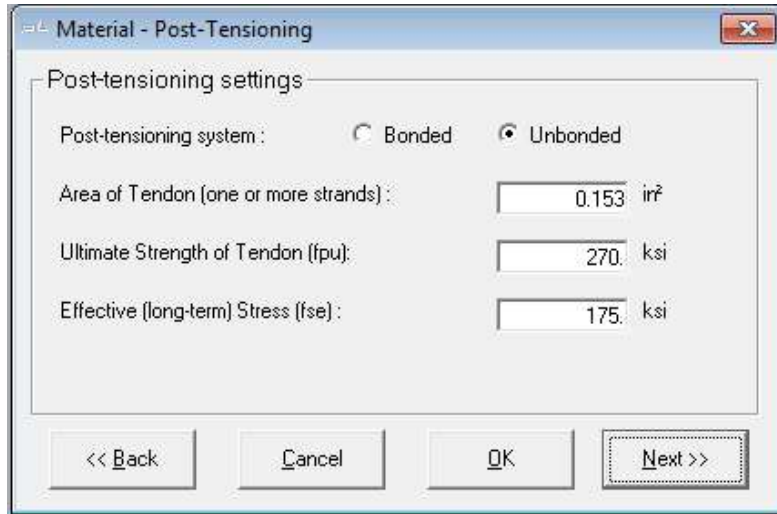
**FIGURE 1.1-11**

Click **Next** at the bottom of the screen to open the next input screen.

### 1.1.4.3 Enter the Post-Tensioning System Parameters

Select the *Post-tensioning system* as **Unbonded** and leave the default values of the other properties as they are as in **Figure 1.1-12**.





**FIGURE 1.1-12**

Click **Next** at the bottom of the screen to open the input screen, *Base Non-Prestressed Reinforcement*.

#### **1.1.4.4 Edit Base Reinforcement**

The program allows you to specify a base reinforcement that is taken into consideration when designing the structure. Select **Yes** in the *Base Reinforcement* section.

You have the choice between defining a mesh or isolated rebar. For this example choose **Isolated** from the drop down box.

Next specify the span where your base reinforcement starts. For this example, let the rebar start at the beginning of span 1. Therefore, enter a **1** in *First end location* and a **0** in *X1/L*.

If you want to specify the end of the reinforcement at the end of span number 4, define **4** for *Second end location* and **1** for *X2/L*.

Furthermore, you specify **4** bars (*Number*) with *Bar Size* of **6** as **Bottom** bars with a *Cover* of **2 inch**.

Base Non-Prestressed Reinforcement

Base Reinforcement  Yes  No

Legend

Type = Mesh reinforcement or single straight bar(s) (Isolated) L = span length associated to X1 and X2 Spacing and cover are in in  
 First end location, Second end location = the spans in which reinforcement starts and terminates Bar size = size of the mesh or isolated rebar  
 X1, X2 = distances of the first and second end of a reinforcement to its immediate left support Number = number of isolated bars  
 Spacing = distance between the mesh bars

	Type	First end location	X1/L	Second end location	X2/L	Bar Size	Number	Spacing	Top/Bottom	Cover
1	Isolated	1	0.00	4	1.00	6	4		Bottom	2
2										
3										
4										
5										

<< Back OK Cancel Next >>

**FIGURE 1.1-13**

Click **Next** at the bottom of the screen to open the input screen, *Criteria – Allowable Stresses*.

## 1.1.5 Edit the design criteria

### 1.1.5.1 Enter the Initial and Final Allowable Stresses

Tensile stresses are input as a multiple of the square root of  $f'_c$ , and compressive stresses are input as multiple of  $f'_c$ .

The default values given in **Figure 1.1-14** are according to **ACI 318 (2014)**. Leave the default values as they are.

Tension stresses			
	Initial Stress / $f_{ci}^{1/2}$	Sustained Stress / $f_c^{1/2}$	Total Stress / $f_c^{1/2}$
Top Fiber :	3.	6.	6.
Bottom Fiber :	3.	6.	6.

Compression stresses			
	Initial Stress / $f_{ci}$	Sustained Stress / $f_c$	Total Stress / $f_c$
	0.6	0.45	0.6

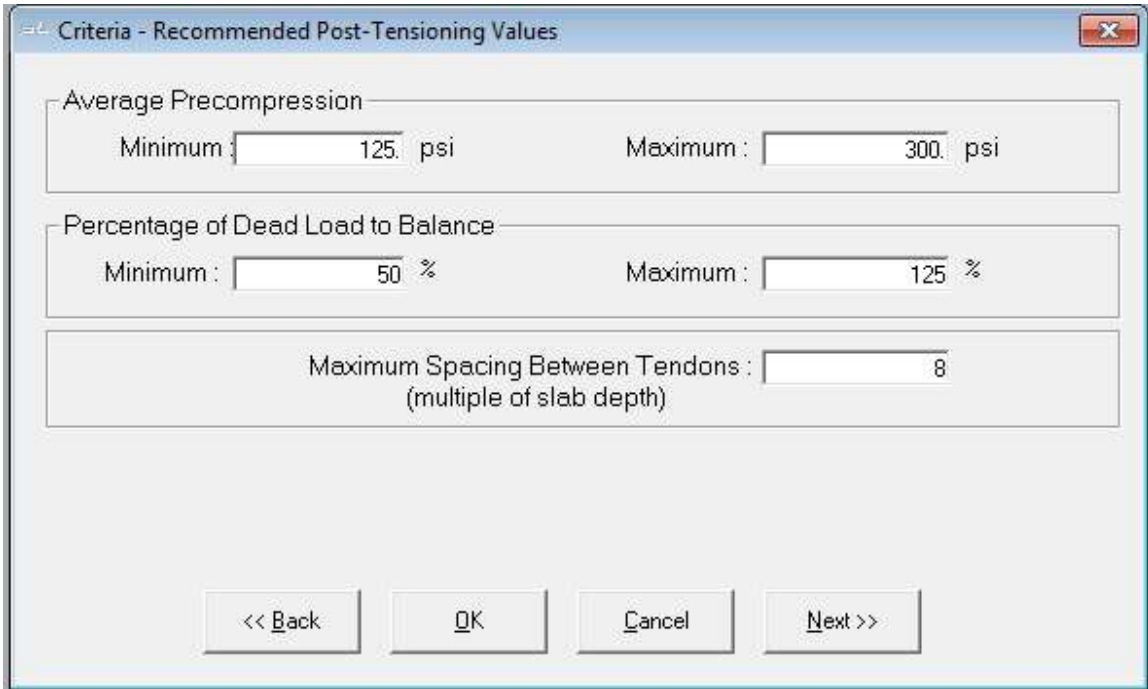
**FIGURE 1.1-14**

Click **Next** at the bottom of the screen to open the next input screen, *Criteria – Recommended Post-Tensioning Values*.

### 1.1.5.2 Enter the Recommended Post-Tensioning Values

This screen is used to specify minimum and maximum values for average precompression ( $P/A$ : total prestressing divided by gross cross-sectional area) and percentage of dead load to balance ( $W_{bal}$ ). These values are used by the program to determine the post-tensioning requirements and the status of the  $P_{min}/P_{max}$  and  $WBAL Min/Max$  indicators on the *Recycle window*.

The values shown in **Figure 1.1-15** are according to the selected code and the experience of economical design.

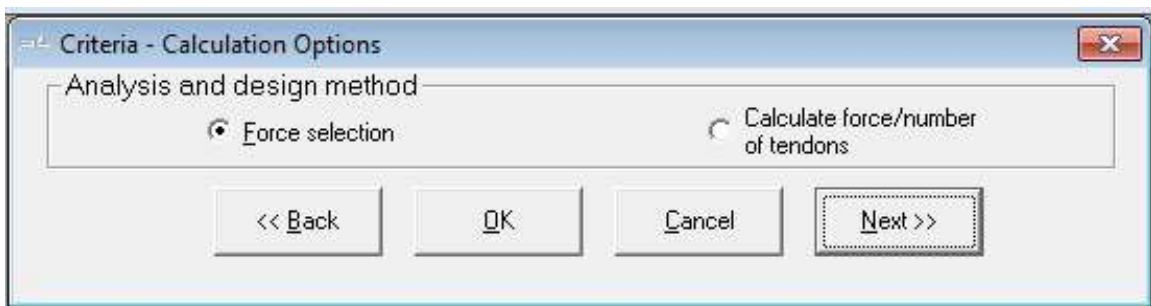


**FIGURE 1.1-15**

Click **Next** at the bottom of the screen to open the input screen, *Criteria – Calculation Options*.

### 1.1.5.3 Select the Post-Tensioning Design Option

The two design options are “Force Selection” and “Force/Tendon Selection”, as in **Figure 1.1-16**. **Force Selection** is the default option. Keep the default option.



**FIGURE 1.1-16**

In this option, a tendon will be assigned a final and constant effective force, equal to the jacking force minus all stress losses, expressed as a single value. For more information on the Calculated Force option, please refer to the **ADAPT-PT/RC 2019 User Manual**.

Click **Next** at the bottom of the screen to open the next input screen, *Criteria – Tendon Profile*.

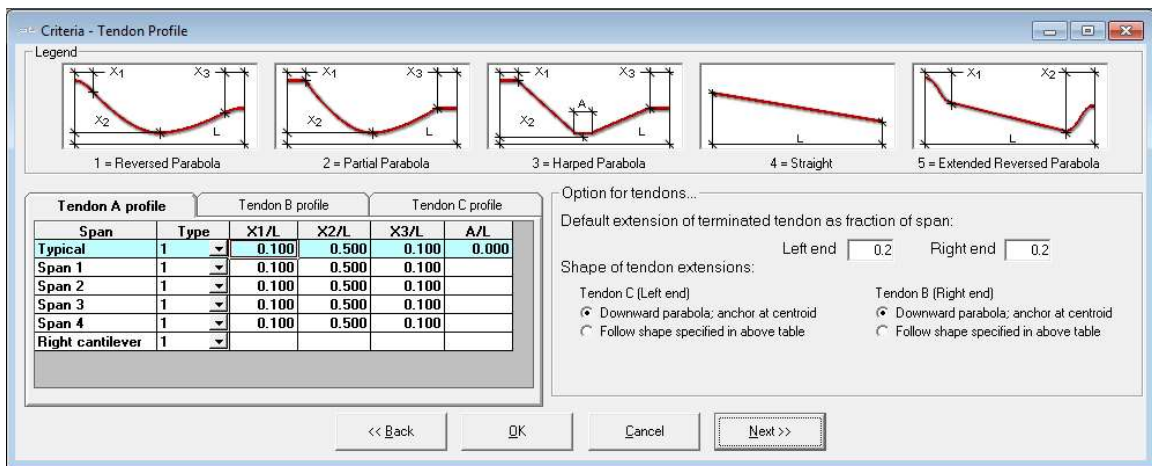
#### 1.1.5.4 Specify the Tendon Profiles

The program allows you to specify up to three tendon paths per span. You can define one profile for each of the three tendons.

In the section *Option for tendons* you can define the *Default extension of terminated tendon as fraction of span*.

Also, you can specify the *Shape of tendon extension* from the *Left end* and the *Right end*.

For this example, leave the default values as shown in **Figure 1.1-17**.



**FIGURE 1.1-17**

Click **Next** at the bottom of the screen to open the next input screen, *Criteria – Minimum Covers*.

#### 1.1.5.5 Specify Minimum Covers for Post-Tensioning Tendons and Mild Steel Reinforcement

The cover for the prestressing steel is specified to the center of gravity of the strand (cgs). Edit *CGS* of the tendon as **1.5 inch** for both the top fiber and the interior spans of bottom fiber and **2.0 inch** for the exterior spans for the bottom fiber.

For nonprestressed reinforcement, edit **1.0 inch** Cover for both the top and the bottom (as shown in **Figure 1.1-18**).

The screenshot shows a software dialog box titled "Criteria: Cover / CGS". It is divided into two main sections. The first section, "Post-tensioning", contains four input fields: "Minimum CGS of tendon from the top fiber" (1.5 in), "Minimum CGS of tendon from the bottom fiber" (1.5 in), "Interior Spans" (1.5 in), and "Exterior Spans" (2 in). The second section, "Non-prestressed Reinforcement", contains three input fields: "Clear Bar Cover (Top)" (1 in), "Clear Bar Cover (Bottom)" (1.0 in), and "Clear Bar Cover (Side)" (1.0 in). At the bottom of the dialog, there are four buttons: "<< Back", "OK", "Cancel", and "Next >>".

**FIGURE 1.1-18**

Click **Next** at the bottom of the screen to open the input screen, *Criteria – Minimum Bar Extension*.

#### 1.1.5.6 Specify Minimum Bar Length and Bar Extension of Mild Steel Reinforcement

The values given as default for “minimum bar lengths” are according to ACI-318 (2014). Use the default values (as shown in **Figure 1.1-19**). Note that the “development length” is user-defined and is the bar extension beyond point of zero moment where reinforcement is no longer required.

The values entered for cut-off lengths are used to calculate top and bottom bar lengths when minimum reinforcement requirements govern. Note that where Rebar Curtailment is input, those settings will take priority over Minimum bar length settings.

**FIGURE 1.1-19**

Click **Next** at the bottom of the screen to open the input screen, *Criteria – Rebar Curtailment*.

### 1.1.5.7 Specify Top and Bottom Rebar Curtailment Input for Spans

The default values given for Long and Short Bars relative for length equal to fraction of span and % of area of required steel are according to Chapter 13 of ACI-318 (2014). Keep the default values (as shown in **Figure 1.1-20** and **Figure 1.1-21**). Note that curtailment rules relative to the selected code are applied to top and bottom bars and are conservatively adjusted such that the bar lengths are equal on both sides of the support or equal at both sides of the center of span. Also, 2 bars are set as a minimum requirement.

The reinforcement result output for this example will be based on the curtailment rules which take priority over reinforcement rules relative to the previous section for bar extensions. In the case where curtailment rules are not sufficient to the default solution (that solution related to the bar extension input) the reinforcement arrangement and length output will be given as that taken from the bar extension input.

Criteria - Reinforcement Curtailment

Description:

Top Bars: ACI-318 Curtailment, Two-Way Slab, Top Bars.

Bottom Bars: ACI-318 Curtailment, Two-Way Slab, Bottom Bars.

Top Bars		Bottom Bars		
	Cantilever	Exterior Span		Interior Span
Longer Bars:	1 * L 0.5 * Ast 0 min bars	0.3 * L 0.5 * Ast 0 min bars	0.3 * L 0.5 * Ast 0 min bars	0.3 * L 0.5 * Ast 0 min bars
Shorter Bars:	0.5 * L 0.5 * Ast 0 min bars	0.2 * L 0.5 * Ast 0 min bars	0.2 * L 0.5 * Ast 0 min bars	0.2 * L 0.5 * Ast 0 min bars

Note: Top bar extensions represent lengths measured from supports

Curtail rules based on:

- None / Off
- User Defined
- ADAPT
- ACI-318
- Eurocode EC2

Curtail lengths based on:

- Clear Span Length
- Support Span Length

Options:

- Apply Curtailment Rules for Top Bars
- Apply Curtailment Rules for Bottom Bars
- Equal Extensions of Top Bars over Support

Curtailment File:

File Open...  
File Save...

<< Back    OK    Cancel    Next >>

FIGURE 1.1-20

Criteria - Reinforcement Curtailment

Description:

Top Bars: ACI-318 Curtailment, Two-Way Slab, Top Bars.

Bottom Bars: ACI-318 Curtailment, Two-Way Slab, Bottom Bars.

Top Bars		Bottom Bars		
	Cantilever	Exterior Span		Interior Span
Longer Bars:	0 * L 0.5 * Ast 2 min bars	0 * L 0.5 * Ast 2 min bars	0 * L 0.5 * Ast 2 min bars	0 * L 0.5 * Ast 2 min bars
Shorter Bars:	0 * L 0.5 * Ast 0 min bars	0 * L 0.5 * Ast 0 min bars	0 * L 0.5 * Ast 0 min bars	0 * L 0.5 * Ast 0 min bars

Note: Bottom bar extensions represent gaps measured from supports.

Curtail rules based on:

- None / Off
- User Defined
- ADAPT
- ACI-318
- Eurocode EC2

Curtail lengths based on:

- Clear Span Length
- Support Span Length

Options:

- Apply Curtailment Rules for Top Bars
- Apply Curtailment Rules for Bottom Bars
- Equal Extensions of Top Bars over Support

Curtailment File:

File Open...  
File Save...

<< Back    OK    Cancel    Next >>

FIGURE 1.1-2



### 1.1.5.8 Input Load Combinations

**Figure 1.1-20** shows the screen which is used to input the load combination factors for service and strength (ultimate) load conditions. It is also used to enter any applicable strength reduction factors. The default values are according to the American-ACI318 (2014)/IBC 2015.

The program allows you to specify four strength load combinations and four service load combinations. For American-ACI318 (2014)/IBC 2015, two of the service load combinations are reserved for sustained load and two for total load.

For this example, do not include lateral loads.

Strength load combination factors										
1:	1.2	SW +	1.6	LL +	1.2	SDL +	1.6	X +	1	HYP
2:	0	SW +	0	LL +	0	SDL +	0	X +	0	HYP
3:	0	SW +	0	LL +	0	SDL +	0	X +	0	HYP
4:	0	SW +	0	LL +	0	SDL +	0	X +	0	HYP

Service load combination factors											
1:	1	SW +	0.3	LL +	1	SDL +	0.3	X +	1	PT	Sustained Load
2:	0	SW +	0	LL +	0	SDL +	0	X +	0	PT	
3:	1	SW +	1	LL +	1	SDL +	1	X +	1	PT	Total Load
4:	0	SW +	0	LL +	0	SDL +	0	X +	0	PT	


Maximum strength reduction factors  
Bending: (max value): 0.9    One-way shear: 0.75    Two-way shear: 0.75

Initial load combination factors  
1: 1 SW + 0 LL + 0 SDL + 0 X + 1.15 PT

Legend  
SW = Selfweight    SDL = Superimposed DL  
LL = Live Load    X = Other Loading

**FIGURE 1.1-22**

## 1.2 SAVE AND EXECUTE THE INPUT DATA

To save the input data and execute the analysis, either select **Execute Analysis** on the menu bar or click on the **Save & Execute Analysis** button . Then, give a **file name** and **directory** in which to save the file. Once the file is saved, the program will automatically execute the analysis by reading the data files and performing a number of preliminary data checks.

Once the execution gets completed, the “PT Recycling” window, as shown in **Figure 1.2-1** opens. If an error is detected, the program will stop and display a message box indicating the most likely source of the error.

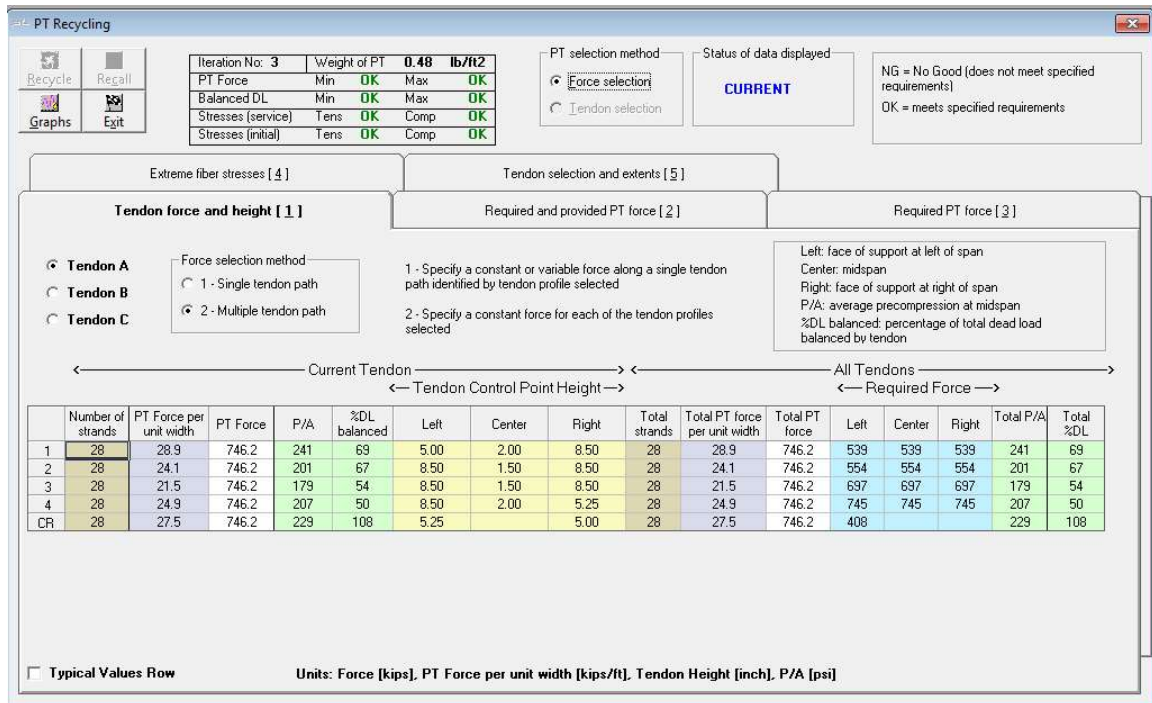


FIGURE 1.2-1

Here you can optimize the design by changing the tendon forces and tendon heights. Select **1-Single tendon path** for the *Force selection method*.

'% DL balanced' is close to the max limit of 125 for CL. For the 'Change the PT force to **500 kips** for CL. The status indicator at the top right of the Recycle window will begin to flash as 'Recycle'.

Since we selected the "Force Selection" option during data entry, the program will only allow the "Force Selection" mode for execution.

Once all of the changes are made as shown in **Figure 1.2-2**, click on the **Recycle** button to update all of the tabs, the Design Indicator box and the Recycle Graphs.

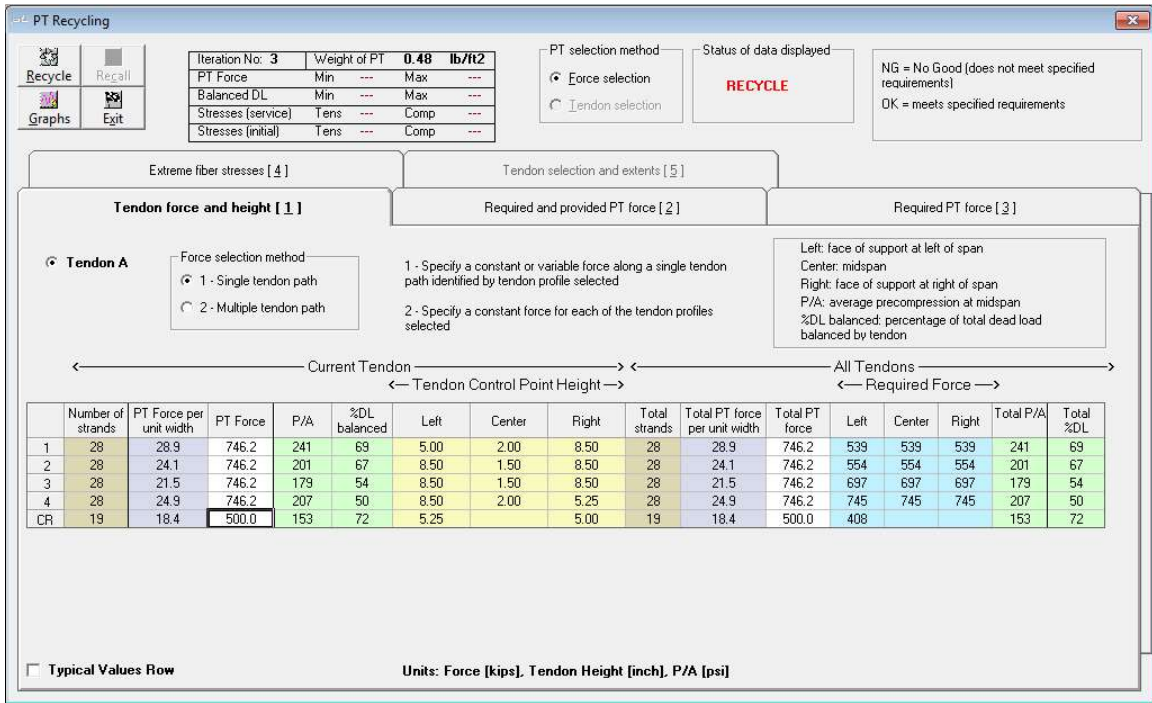


FIGURE 1.2-2

After the recalculation of the stresses and required forces along the member, based on the current values, the window, as shown in **Figure 1.2-3**, with the “OK” status for all items in the *design indicator box* opens.

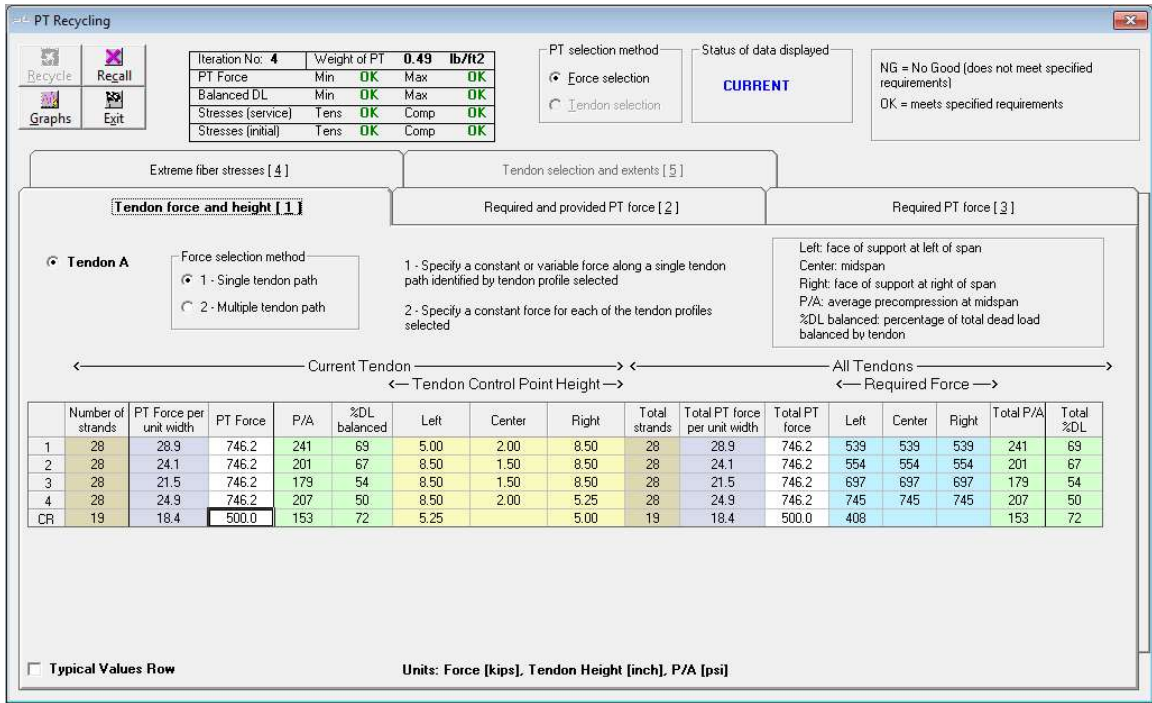


FIGURE 1.2-3

You can check the final stresses either by clicking **Extreme fiber stresses [4]** tab in the *PT Recycling* window (Figure 1.2-4).

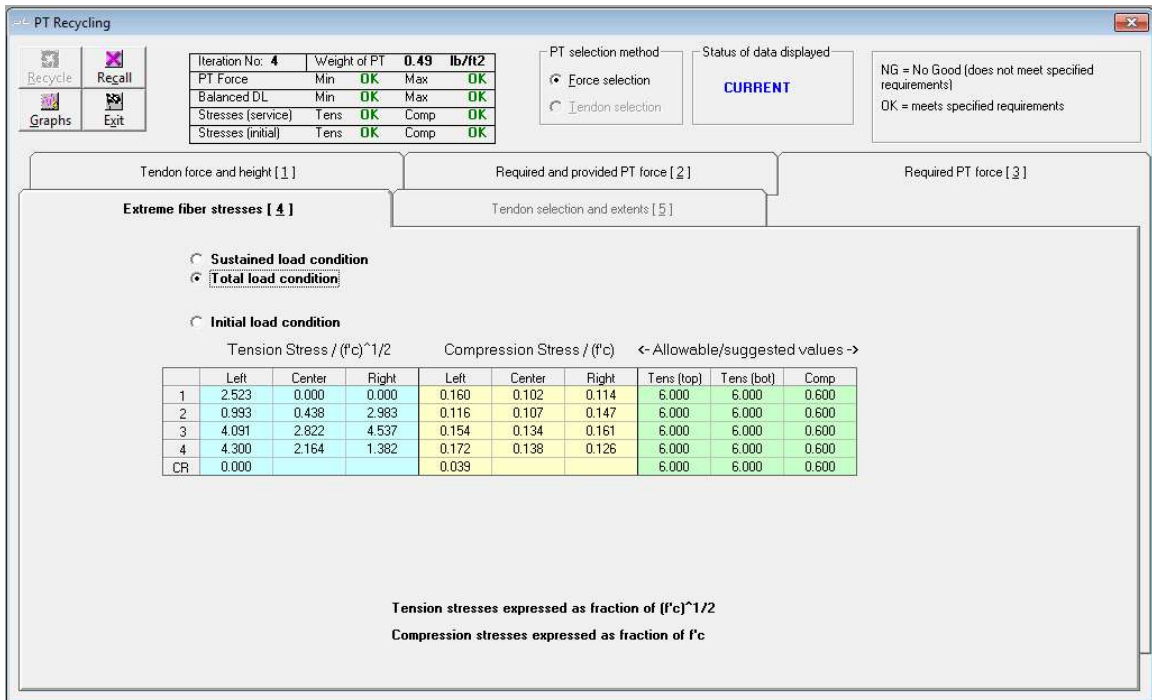
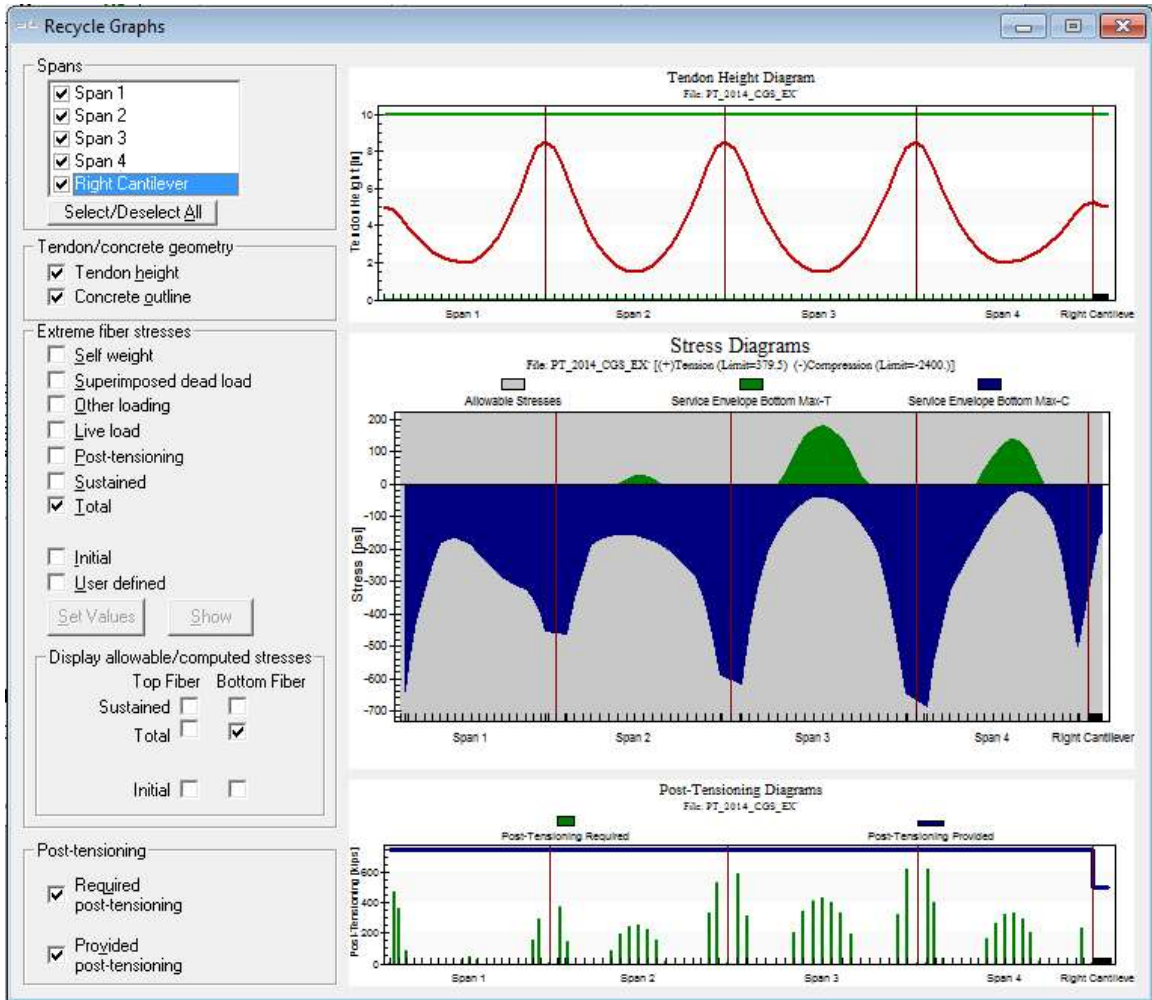


FIGURE 1.2-4

**Graphs** displays a set of three graphs which provide detailed information on the tendon profile, the tension and compression stresses and the required versus provided post-tensioning forces at 1/20<sup>th</sup> points along the spans (**Figure 1.2-5**).



**FIGURE 1.2-5**

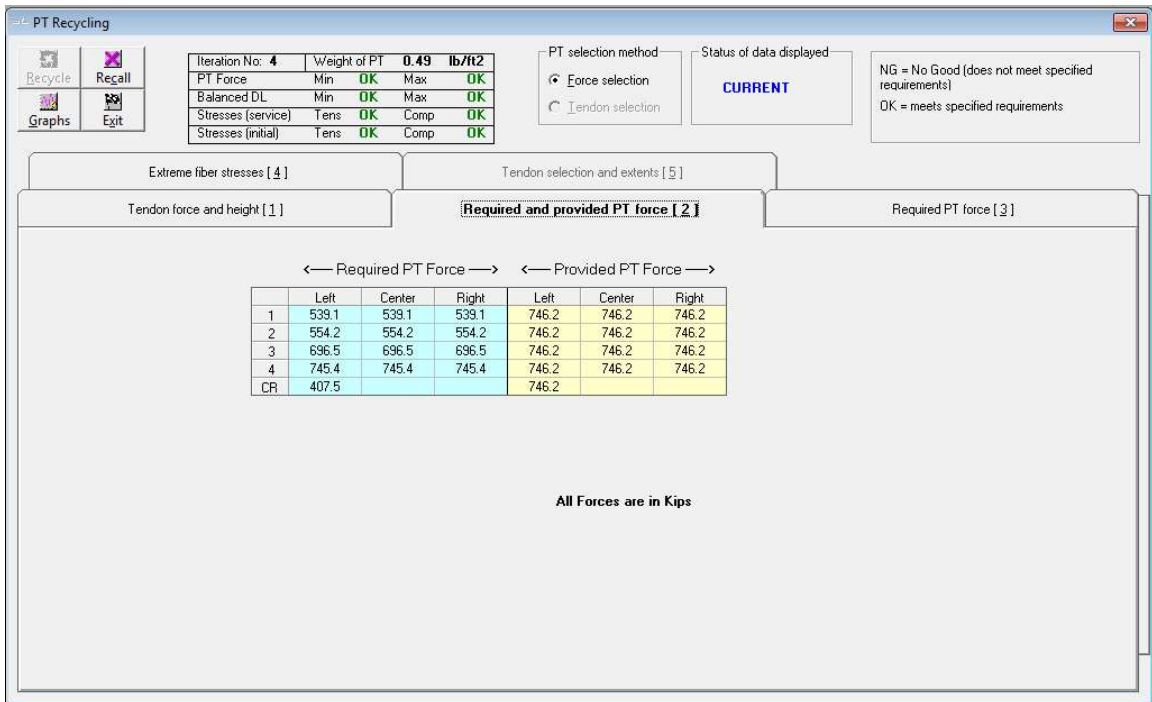
The top diagram, the **Tendon Height Diagram** shows the elevation of tendon profile selected. Tendon profile can be viewed either with concrete outline or without concrete outline by checking the option at the left of the screen.

The second diagram, **Stress Diagrams**, plots the maximum compressive and tensile stresses at the top and bottom face of the member. You can view the stresses due to e.g. *Self-weight*, *Superimposed Dead Load*, *Live Load*, *Post-tensioning* and *Sustained* each separately, or in combination, by selecting the options at the screen. Also you can verify the top and bottom stresses due to the service combination with the allowable values. In **Figure 1.2-5**, it shows the final top fiber stresses with the allowable stresses.

In which, *gray color* represents the allowable value, *top curve* represents the tensile stress and *bottom curve* represents the compressive stress. If the calculated stress is not within the limit, i.e., the top or bottom curve is outside the gray portion; you need to modify the forces to optimize the design.

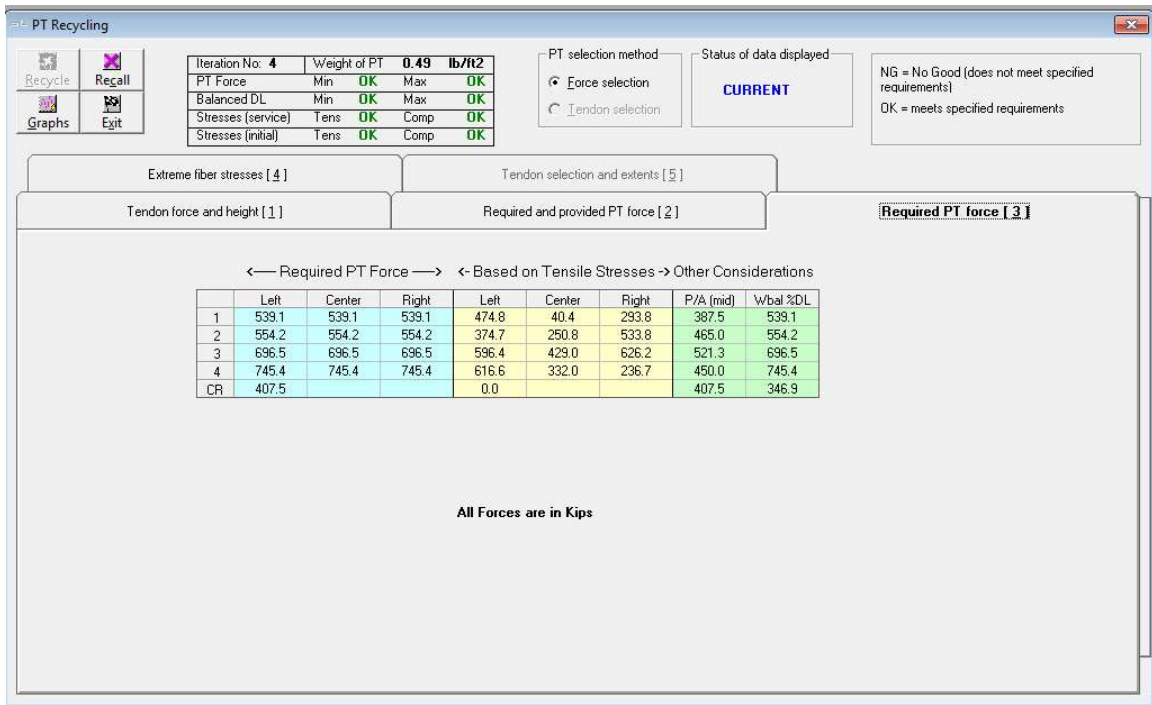
The third diagram, **Post-Tensioning Diagrams** shows the required and provided post-tensioning force at 1/20th points along each span. The *vertical line* represents the *required* post-tensioning and the *horizontal line* represents the *provided* post-tensioning at that section. At each design section along a span, the program performs an analysis based on the post-tensioning force at that section

**Required and provided PT force [2]** tab in the *PT Recycling* window shows PT forces provided in the left, center and right region of each span as well as the forces required in each region for minimum P/A, Wbal %DL and allowable tensile stresses (**Figure 1.2-6**).



**FIGURE 1.2-6**

**Required PT force [3]** tab in the *PT Recycling* window shows the required PT forces for only the most recently calculated profile. (**Figure 1.2-7**).

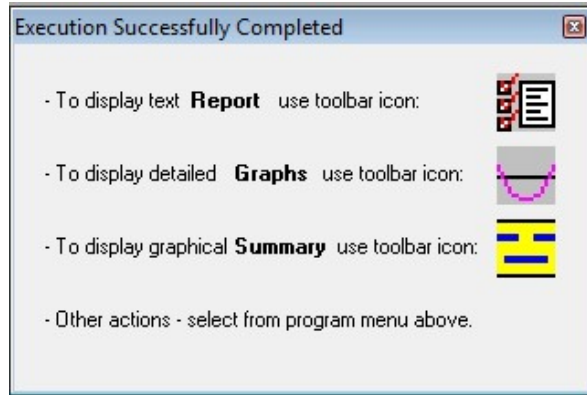


**FIGURE 1.2-7**

Note that in this example, **Tendon selection and extents [5]** tab in the *PT Recycling* window is inactive, as single-tendon path has been chosen.

If the solutions are not acceptable, you can change post-tensioning layout and recycle until an acceptable solution is reached. Once you are satisfied with the solution, select **Exit** at the top left of the *PT Recycling* screen to continue with the calculations.


The program continues with the calculations based on the most recent tendon forces and profile selection. Once successfully finished, you return to the main program window. The Results can be viewed and/or printed as Reports, Graphs and PT Summary as shown in **Figure 1.2-8**.



**FIGURE 1.2-8**

Close the above window by clicking **X** at the top right corner.

### **1.3 CREATE REPORTS**

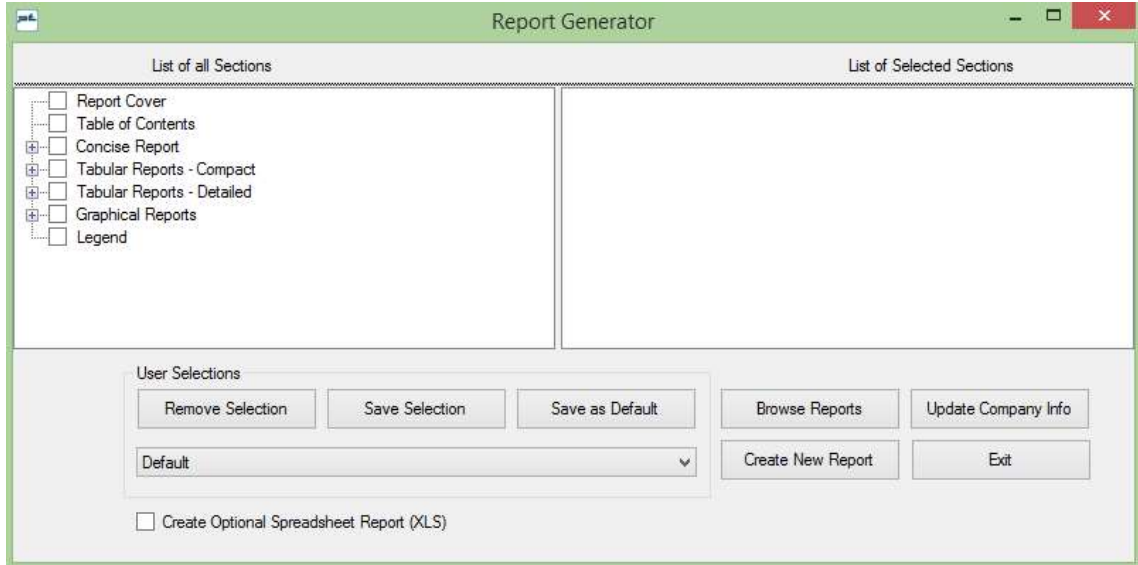
ADAPT-PT/RC 2019 includes the **Report Generator**. To setup the report, select the **Report Setup** item on the *Options* menu or click the **Report Setup** button  on the main toolbar. The *Report Generator* screen shown in **Figure 1.3-1** will open.

The program allows you to generate reports in an MS-Word® editable format. You have the following options:

- Report cover: Select this option to generate a report cover with your logo and company information. To update your company information, click on **Update Company Info** on the *Report Generator* and you will see the screen **Company Information** shown in **Figure 1.3-2**.
- Table of Contents
- Concise Report: This report includes Project Design Parameters and Load Combinations as well as a Design Strip Report containing Geometry, Applied Loads, Design Moments, Tendon Profile, Stress check / Code check, Rebar Report, Punching Shear, Deflection and Quantities.
- Tabular Reports – Compact
- Tabular Reports – Detailed
- Graphical Reports



- Legend



**FIGURE 1.3-1**

Simply check any item in the *List of all Sections* to include it in the report. The item will then appear in the *List of Selected Sections* on the right hand side of the *Report Generator*.

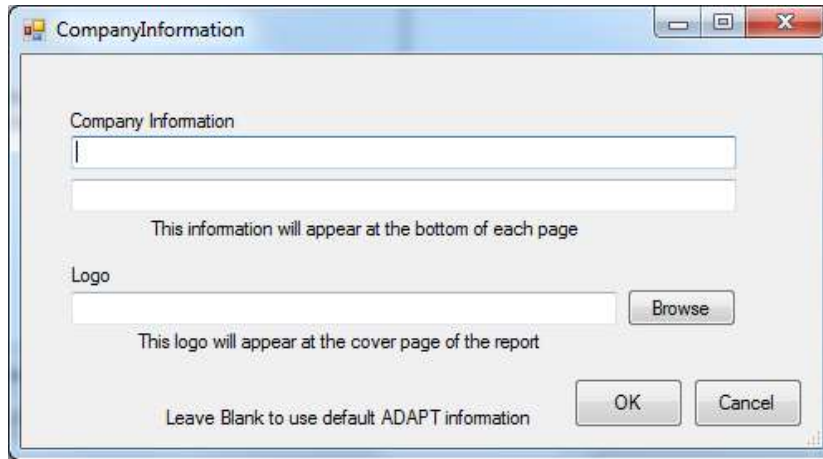
To generate and view the report, click on **Generate/View Report** on the bottom of the *Report Generator*.

The program allows you to open and view existing reports by clicking on **Open Reports**.


The Report Generator allows you to save report content as either a default template or as a user defined template. This enables you to quickly select content for any project by either using the default content or any other user defined content.

To define content as the default template, select report content from the List of all Sections and click on **Save as Default**.

To define content as a user defined template, select report content from the List of all Sections and click on Save Selection. You are asked to enter a name for your selection. This name appears then in the drop down box in the **User Selections** frame.



**FIGURE 1.3-2**

To open the “PT Summary Report” (**Figure 1.3-3**) either click the **BuilderSum** button  on the tool bar or select the **PT summary** item on the *View* menu.

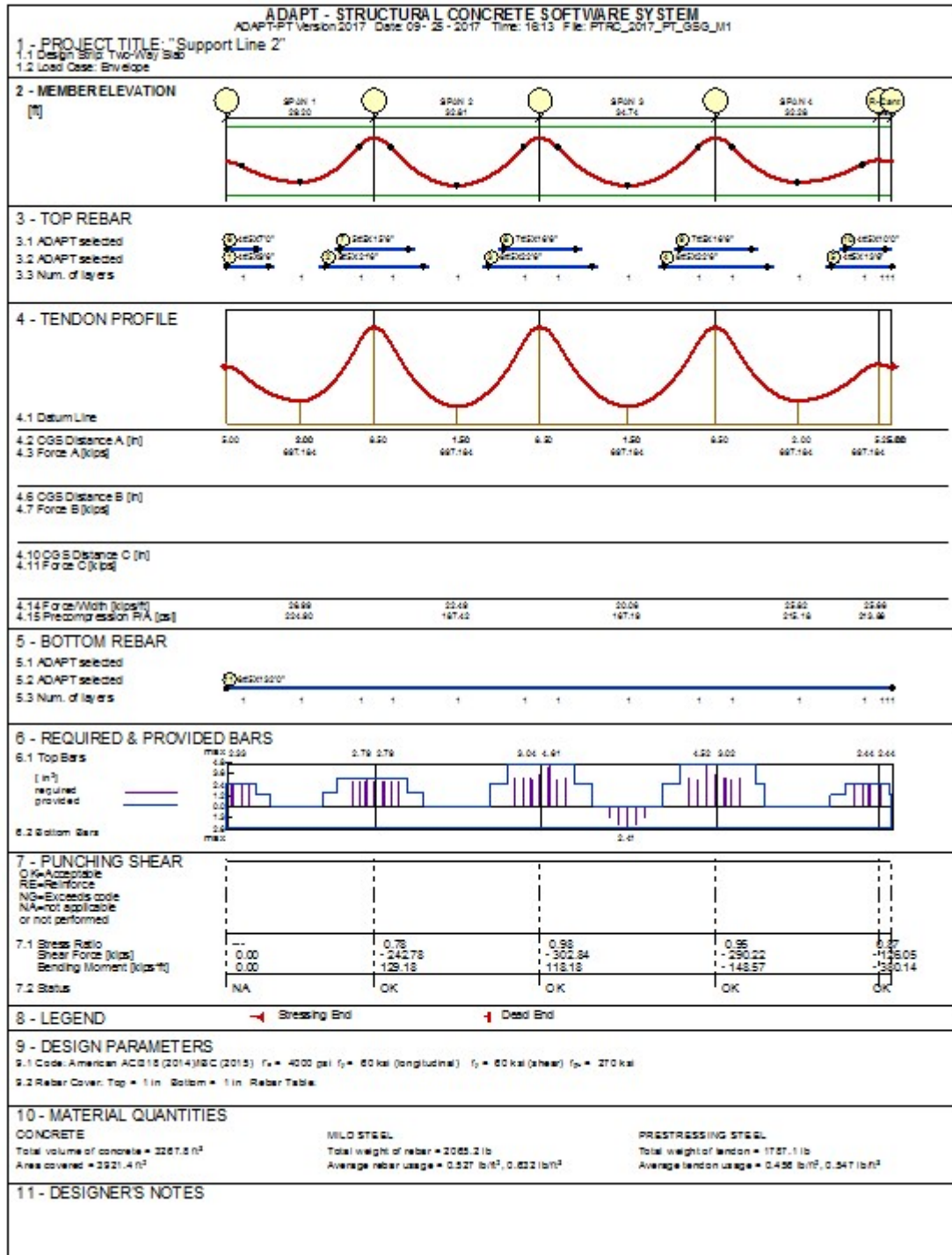

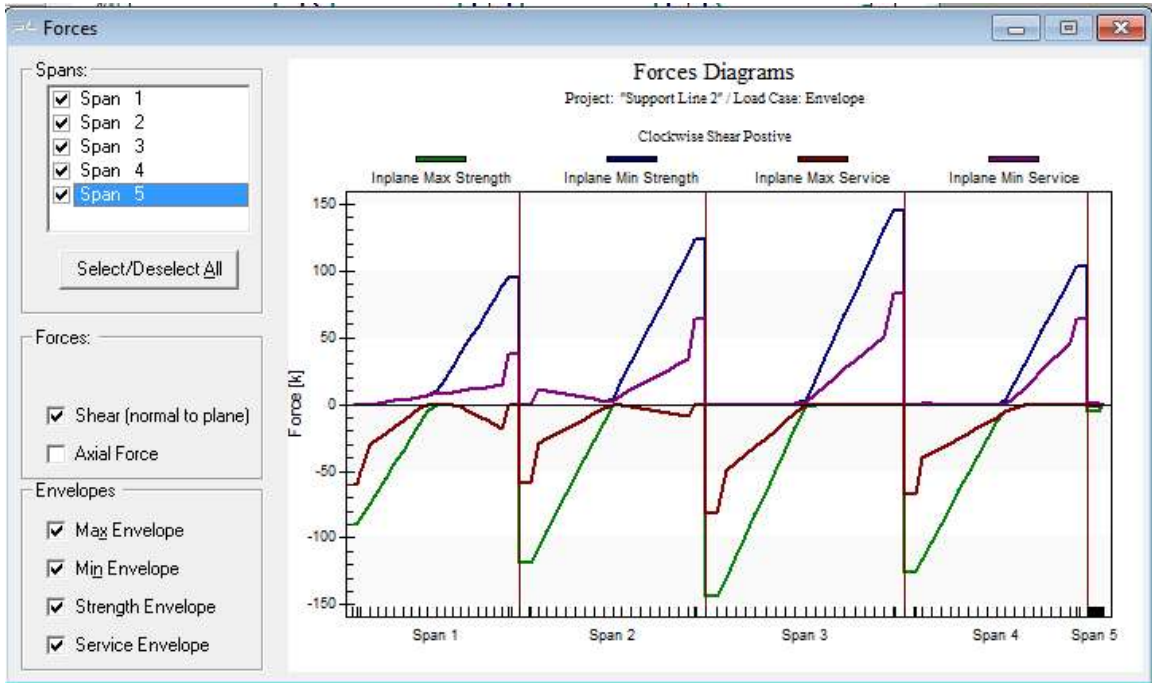



FIGURE 1.3-3

To view the graphs, either click the **Show Graphs** button  from the toolbar or select **Graphs** in the menu.

**Forces Diagram** button  displays forces for selected load combinations or envelop as shown in **Figure 1.3-4**.



**FIGURE 1.3-4**

**Moment Diagram** button  displays forces for selected load combinations or envelop as shown in **Figure 1.3-5**.

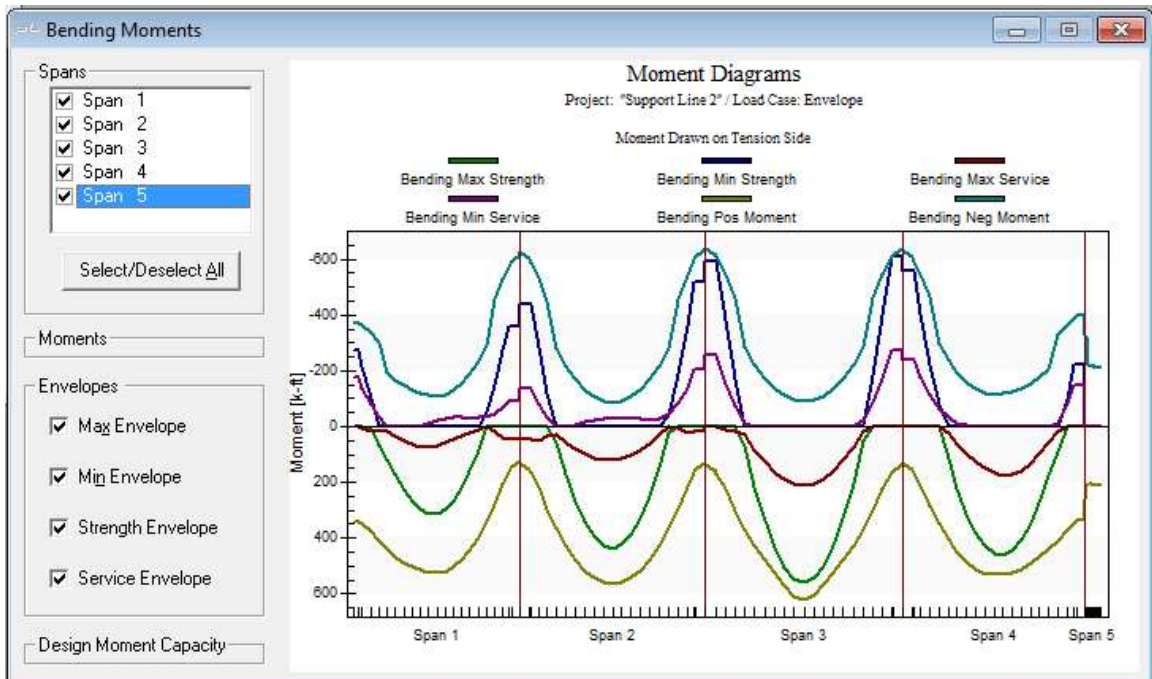



FIGURE 1.3-5

**Stresses Diagram** button  displays forces for selected load combinations or envelop as shown in **Figure 1.3-6**.

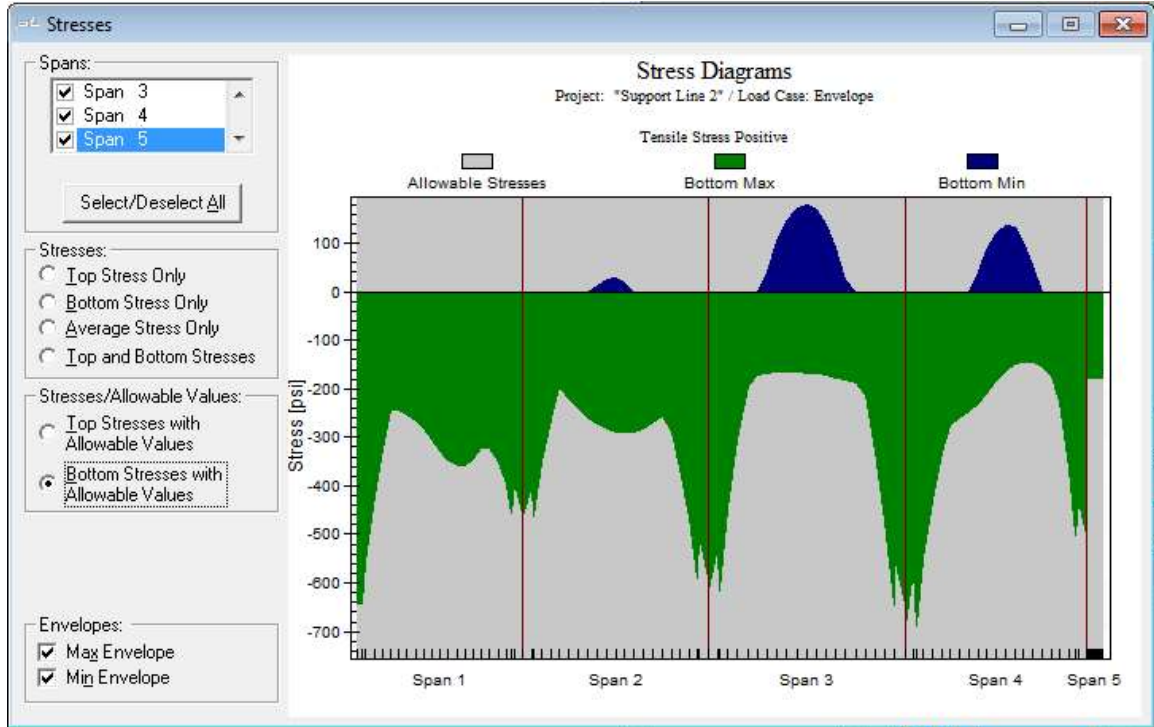

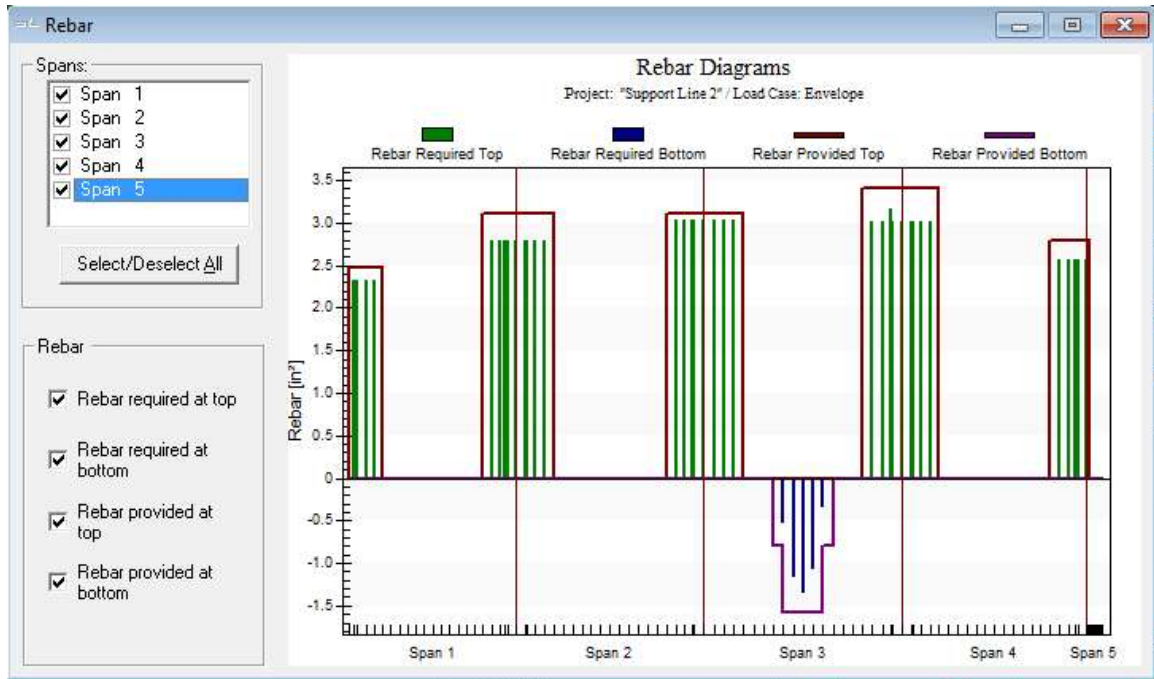


FIGURE 1.3-6

**Rebar Diagram** button  displays forces for selected load combinations or envelop as shown in **Figure 1.3-7**.



**FIGURE 1.3-7**

**Additional references to be consulted with this manual:**

1. ADAPT-PT/RC 2019 User Manual
2. ADAPT-PT/RC 2019 Getting Started Tutorial – RC mode
3. ADAPT-PT/RC 2019 Verification Manual